

BATTLETECH[®]

THE FUTURE OF WARFARE[™]

8 6 1 9

TECHNICAL[™]
READOUT:

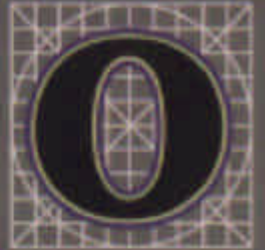

F959

SELECT BATTLETECH IMAGES COURTESY OF VICTOR MUSICAL INDUSTRIES, INC.

REVISED EDITION



T E C H N I C A L

R E A D O U T

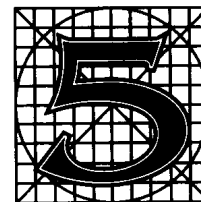
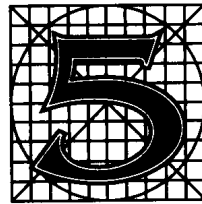
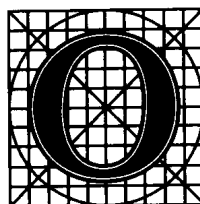

F A S A C O R P O R A T I O N

Introduction	4	Berserker	88
Inner Sphere Prototypes	6	Grand Titan	90
Light 'Mechs	9	Clan 'Mechs	92
Fireball	10	Second-line 'Mechs	94
Dart	12	Baboon	96
Tarantula	14	Vixen	98
Battle Hawk	16	Jenner IIC	100
Hammer	18	Peregrine	102
Hitman	20	Hellhound	104
Jackal	22	Goshawk	106
Scarabus	24	Galahad	108
Hollander	26	Viper	110
Venom	28	Behemoth	112
Medium 'Mechs	31	Kraken	114
Daimyo	32	OmniMechs	116
Watchman	34	Phantom	118
Komodo	36	Pouncer	120
Snake	38	Linebacker	122
Stealth	40	Naga	124
Huron Warrior	42	AEROSPACE SUPERIORITY	126
Nightsky	44	Bashkir	128
Apollo	46	Vandal	130
Grim Reaper	48	Avar	132
Wraith	50	Batu	134
Heavy 'Mechs	53	Sulla	136
Anvil	54	Turk	138
Tempest	56	Visigoth	140
Daikyu	58	Jagatai	142
Gallowglas	60	Sabutai	144
Hercules	62	Jengiz	146
Thunder	64	Scythia	148
Bandersnatch	66	Kirghiz	150
Falconer	68	INDEX	152
Penetrator	70		
Rakshasa	72		
War Dog	74		
Assault 'Mechs	77		
Salamander	78		
Gunslinger	80		
Albatross	82		
Cerberus	84		
Naginata	86		

TECHNICAL READOUT: 3055, REVISED EDITION

Original Technical Readout: 3055

Design

RealTime Associates:

Mike Bently

Dave Coriveau

Brent Carter

Eric Garvis

Christine Mackay

Laurie Mair

Gene Marcil

Staphané Matis

Mike Pellicciotti

Jerry Stenson

Bryan Nystul

Blaine Pardoe

Bob Charette

Chris Hartford

Ashley Watkins

Development

Mike Nystul

Editorial Staff

Senior Editor

Donna Ippolito

Assistant Editor

Sharon Turner Mulvihill

Production Staff

Art Director

Jeff Laubenstein

Project Manager

Jeff Laubenstein

Cover Art

Steve Venters

Kazuhiko Miyake

Cover Design

Jeff Laubenstein

Illustration

Dana Knutson

Mike Nielsen

Joel Biske

Layout

Tara Gallagher

Keyline and Pasteup

Ernie Hernandez

Technical Readout: 3055, Revised Edition

BattleTech Line Developer

Bryan Nystul

Development

Bryan Nystul

Randall N. Bills

Editorial Staff

Editorial Director

Donna Ippolito

Managing Editor

Sharon Turner Mulvihill

Associate Editors

Diane Piron-Gelman

Rob Cruz

Production Staff

Art Director

Jim Nelson

Assistant Art Director

Joel Biske

Project Manager

Mark Ernst

Cover Art

Steve Venters

Kazuhiko Miyake

Cover Design

Jeff Laubenstein

Illustrations

Joel Biske

Dana Knutson

Jeff Laubenstein

Mike Nielsen

Layout

Mark Ernst



BATTLETECH®, MECH®, BATTLEMECH®, and MECHWARRIOR® are Registered Trademarks of FASA Corporation. BATTLETECH TECHNICAL READOUT: 3055 is a Trademark of FASA Corporation.

Copyright © 1996 FASA Corporation. All Rights Reserved. Printed in the U.S.A.

Published by: FASA Corporation, 1100 W. Cermak Road Suite B305 Chicago, IL 60608

FASA Corporation can be reached on America OnLine (E. Mail—FASALou (Earthdawn), FASAInfo (BattleTech, Shadowrun and General Information) or FASA Art (Art Comments)) in the Online Gaming area (Keyword "Gaming"). Via Inter Net use <AOL Account Name>@AOL.COM, but please, no list or server subscriptions. Thanks!

Visit FASA on the World Wide Web at <http://www.FASA.com>

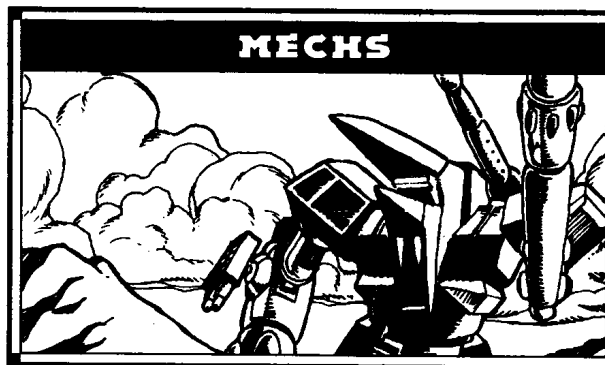

In the wake of the invasion of the Inner Sphere by the Clans, both sides struggle to strengthen their positions and prepare for what many now refer to as the Truce End.

New BattleMechs have surfaced both in Inner Sphere units and among the Clans. Technological advances that were in their infancy in 3050 have come of age and are being used in bold new designs. Our Blessed Order has assigned me to prepare this manual to keep our members up-to-date on the sweeping changes in the weapons being developed for the day when the Inner Sphere and the Clans clash once more. As everyone knows, the peace of Tukayyid is only a respite. The Clans will not rest in their dream of capturing Terra, nor will we in our zeal to defend the homeworld of mankind.

This document contains our best intelligence regarding this new technology. The first section of this book describes 38 BattleMechs being produced by the Great Houses of the Inner Sphere in response to the seemingly unstoppable might of the Clan military machine. The second section describes new Clan BattleMechs that we have identified. These include four Clan Wolf OmniMechs and 10 second-line BattleMechs. Last, we present information on the twelve most common OmniFighters used by the Clans during the invasion.

My staff and I gratefully acknowledge the assistance of Precentor Martial Anastasius Focht, without whose first-hand knowledge of the Clans this book would not have been possible. It has been my great honor to have worked with him for nearly a decade and I salute his rise from commander of the Com Guards to savior of the Inner Sphere.

He is an inspiration to us all.

—Merle Jimmus
Adept XXI-sigma
ComStar Archives, Terra
15 July 3055



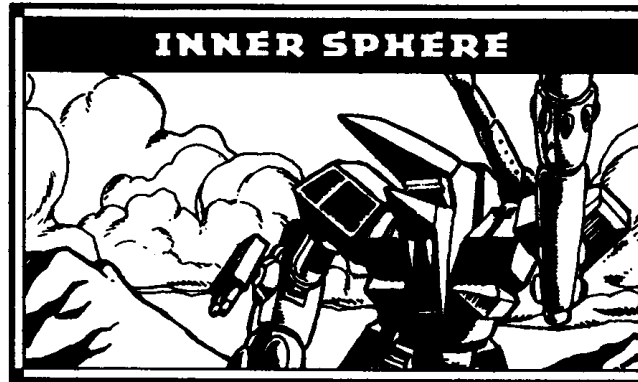

The Clans caught the Inner Sphere by surprise with their first wave of attacks. The commanders of the Great Houses were unprepared for the superior technology and savage skill of the invasion force. Fortunately, leaders such as Theodore Kurita and Hanse Davion were able to adapt and turn the tide. The heroic efforts of the Com Guards and the brilliance of our Precentor Martial stopped the invasion at Tukayyid, but we cannot continue to rely on good fortune.

During the invasion, many new BattleMechs were made available to the forces of the Inner Sphere, as outlined in my report of 3050. Most of these designs were retrofits of standard 'Mechs or prototypes put into production prematurely in panicked response to the Clan menace. The Com Guards have given the Inner Sphere a fifteen-year cease-fire in the war with the Clans, and so new designs now can be fully tested before they are put into production.

Aware of the need to close the Inner Sphere's technological gap with the Clans, most of the Great Houses have made production of advanced designs a priority. Production of the "newtech" of 3050 is not yet equal to the overwhelming demand, however, and most of these new BattleMechs will not be deployed in force for some time.

Initially, the most terrifying Clan units were the Elementals. Many MechWarriors viewed them as a nightmare come to life. Several anti-Elemental 'Mech designs such as the Draconis Combine's *Komodo* went into immediate production, but as MechWarriors became familiar with the "toads" and discovered how to fight them effectively, most of the BattleMechs originally intended for duty as "Elemental hunters" were reassigned.

Most of these designs first saw action late in 3054 and early 3055. The Great Houses will probably take advantage of the cease-fire to put additional design development on hold, instead testing the effectiveness of the new 'Mechs and refining the integration of advanced technology. At the moment, Inner Sphere commanders are far more concerned with overcoming the Clans' technological edge using innovative strategy.

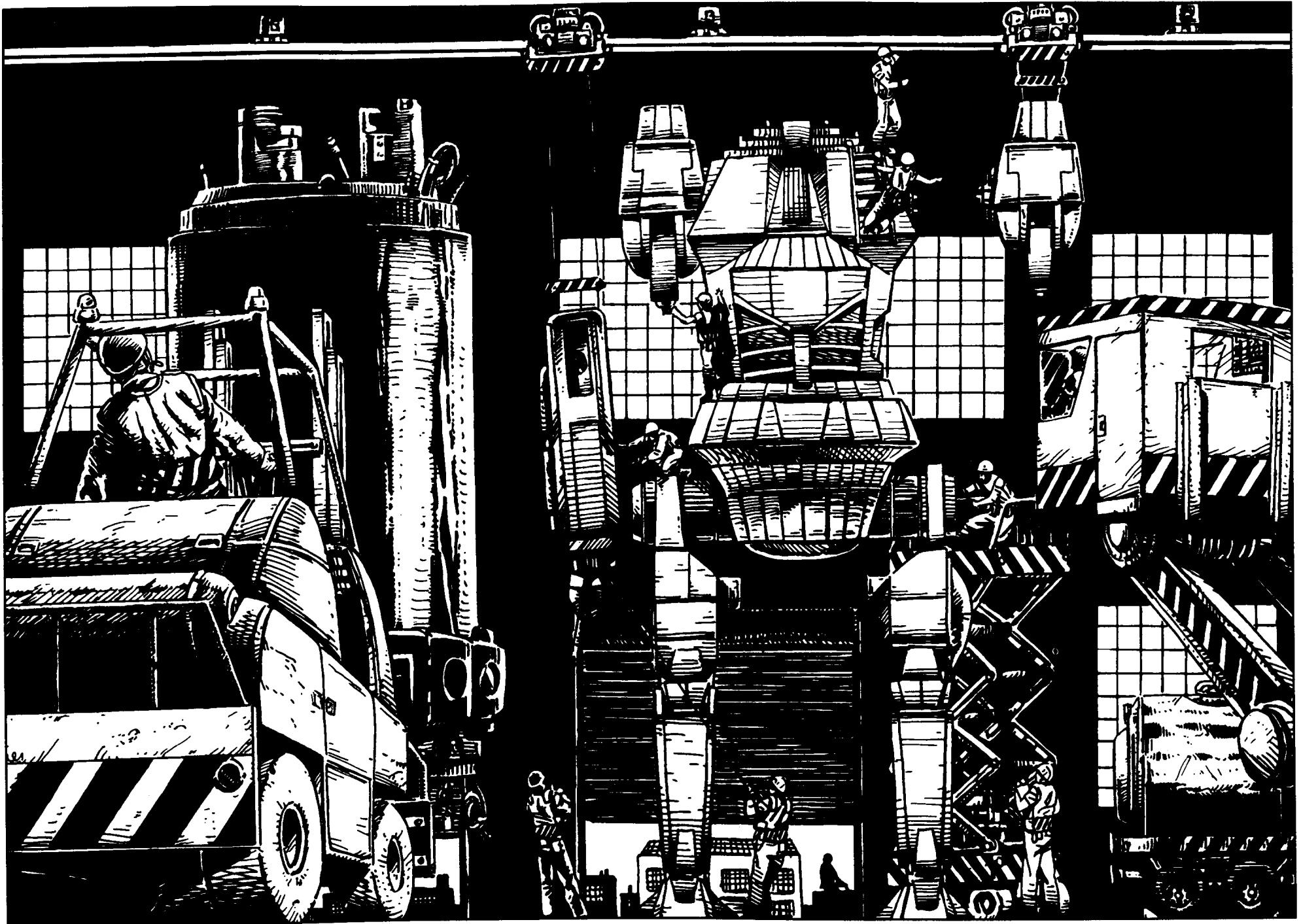



LIGHT 'MECHS



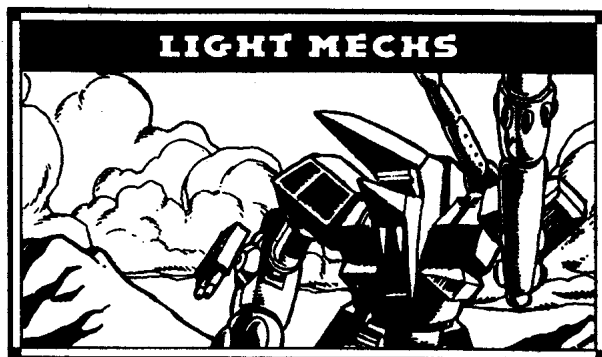

Mass: 20 tons
Chassis: Corean Model 334AA Endo Steel
Power Plant: DAV 220 XL
Cruising Speed: 120 kph
Maximum Speed: 184 kph
Jump Jets: None
Jump Capacity: None
Armor: Durallex Nova
Armament:
 1 Hovertec Streak SRM-2 Rack
 1 LFN Lindblad Machine Gun
Manufacturer: Corean Enterprises
Primary Factory: New Avalon
Communications System: Lynx-shur
Targeting and Tracking System: Corean B-Tech

Overview:

While trying to formulate a strategy to counter the onslaught of the Clans, the Federated Commonwealth commanders held a series of talks with designers at the New Avalon Institute of Science. The outcome of the discussions was a decision to build a light BattleMech that could support heavier units when they suddenly encountered Clan Elementals in combat. The Federated Commonwealth commissioned the ALM-7D Fireball soon after these debates and immediately dedicated some of the Corean Enterprises assembly lines on New Avalon to the new design.

Capabilities:

Of the several designs submitted to the Federated Commonwealth Review Board, the 7D was the most promising. Because Clan Elementals swarm onto the battlefield in large numbers, the design called for a quick vehicle that could sustain a high fire rate for an extended period of combat time. The 'Mech was armed with a Hovertec Streak SRM-2 missile rack and a Lindblad machine gun, both supplied with substantial ammunition. These weapons seemed well-suited to opposing Elementals, but the feature that most caught the eye of the review board members was its speed.

The ALM-7D can run up to 184 kph even without the dangerous MASC equipment. With a good gunner commanding the 'Mech, the machine could race across the battlefield supporting several heavier units.

To meet the needs of these combat conditions, the engineers incorporated the Corean B-Tech targeting and tracking system in the internal components, a system that had proven its effectiveness in recent years. This system was also chosen because a substantial number was available at the New Avalon manufacturing site, thus eliminating lengthy delays for transporting components from other worlds.

Deployment:

The Federated Commonwealth plans to test the performance of the ALM-7D in front-line situations where veteran units will pit their expertise against the Clans. The new design will most likely be assigned to hot young pilots because the *Fireball's* capabilities suit the individuality of many newer MechWarriors. The F-C High Command hopes that piloting a *Fireball* will help the rookies mature more quickly than they would in a heavier line 'Mech that has to submit to a more coordinated battle strategy.

Variants:

Since the *Fireball's* introduction into the Federated Commonwealth's armed forces, successful field modifications have resulted in the creation of two variants.

The variations both involve weapon replacement. One replaces the Streak SRM-2 and ammo in the left torso with two medium lasers. A different tech in the same company that produced the first variation replaced a damaged *Fireball's* right-torso machine gun and ammo with a medium laser and some additional armor. Both variants have performed quite well thus far.

Type: Fireball
Technology Base: Inner Sphere
Tonnage: 20

Equipment		Mass
Internal Structure:	Endo Steel	1
Engine:	220 XL	5
Walking MP:	11	
Running MP:	17	
Jumping MP:	0	
Heat Sinks:	10	0
Gyro:		3
Cockpit:		3
Armor Factor:	64	4
	<i>Internal Structure</i>	<i>Armor Value</i>
Head	3	9
Center Torso	6	9
Center Torso (rear)		2
R/L Torso	5	8
R/L Torso (rear)		2
R/L Arm	3	5
R/L Leg	4	7

Weapons and Ammo	Location	Critical	Tonnage
Streak SRM 2	LT	1	1.5
Ammo (Streak) 50	LT	1	1
Machine Gun	RT	1	.5
Ammo (MG) 200	RT	1	1

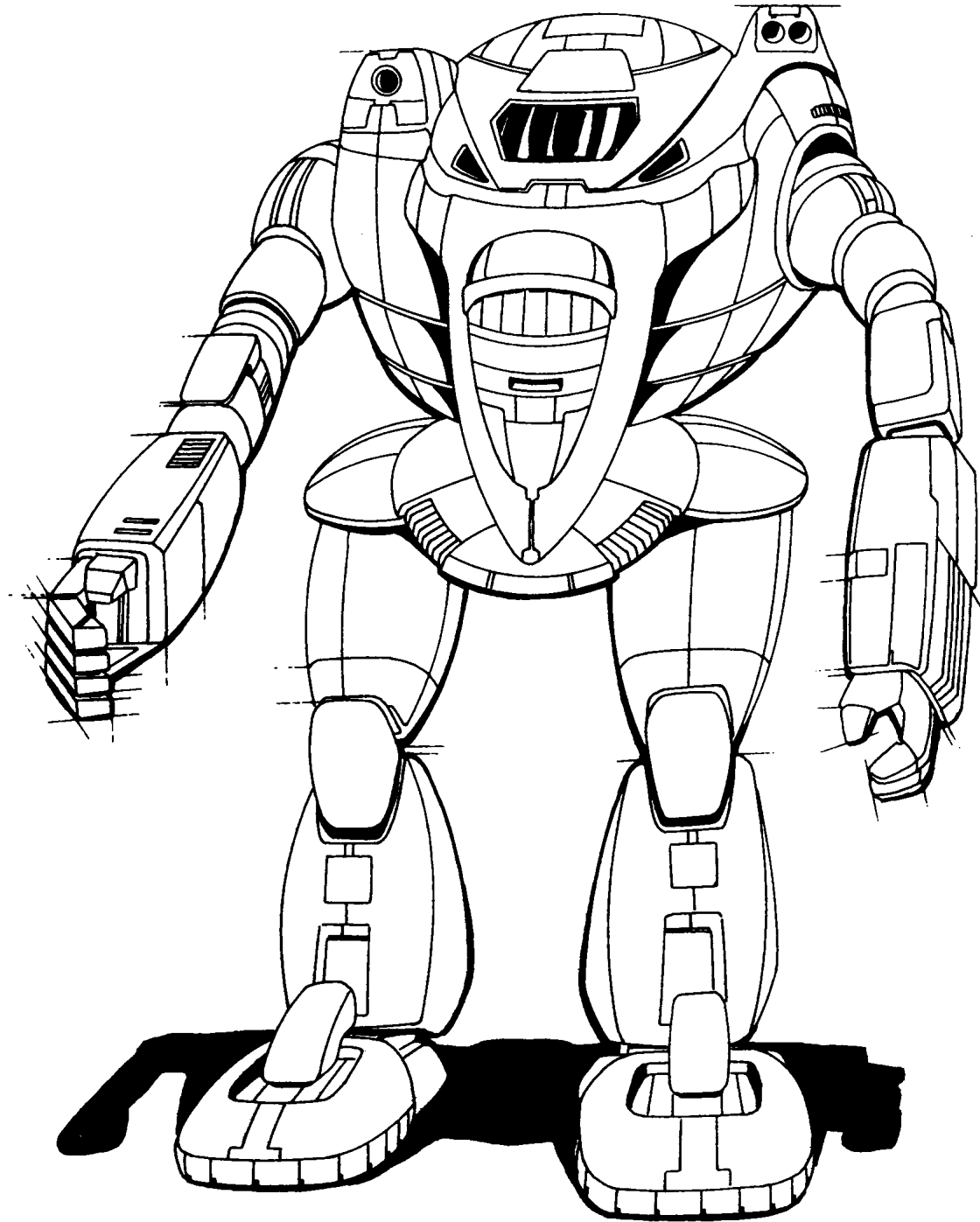

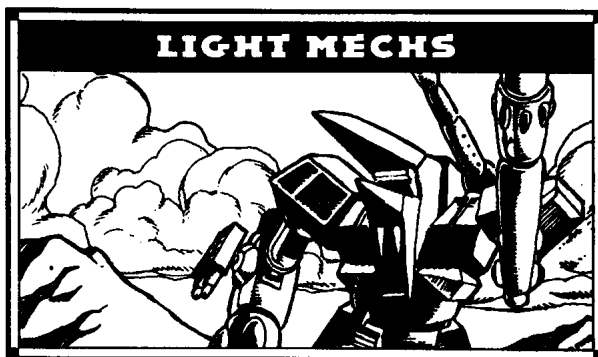

Mass: 25 tons
Chassis: Coventry Metal Works Model D-3
Power Plant: VOX 225
Cruising Speed: 97 kph
Maximum Speed: 151 kph
Jump Jets: None
Jump Capacity: None
Armor: Lexington Limited
Armament:
 3 Magna 200P Small Pulse Lasers
Manufacturer: Coventry Metal Works
Primary Factory: Coventry
Communications System: Cyclops 14
Targeting and Tracking System: Cyclops
 Multi-Tasker 10

Overview:

After the *Commando* and the *Valkyrie* were designated as the standard light BattleMechs for the Federated Commonwealth, several battle reports have suggested that the high amounts of ammunition aboard these 'Mechs limit their effectiveness in tight combat situations.

Coventry Metal Works, in an obvious public relations move, suggested a new design to the Federated Commonwealth military for their consideration. Much to Coventry's surprise, the Office of Procurement accepted the design and ordered immediate construction.

Capabilities:

The *Dart* is a fast 'Mech equipped with three Magna small pulse lasers as its weaponry. In the fast-strike mentality that pervades the upper echelon of the Federated Commonwealth military, this design will be used primarily in raids on Clan supply depots and in actions to cut off front-line Clan 'Mechs from their supply lines. When more of the *Dart* 'Mechs become available, they will also serve in scouting missions.

The three small pulse lasers were chosen because of their accuracy in short-range situations. The *Dart* frame's 3.5 tons of armor provide ample protection from small Clan 'Mechs and Elementals. The 'Mech also has a remarkable speed of 151 kph, making it faster than any known *Commando* variant in existence.

Deployment:

Before the Clan invasion, standard practice for field-testing was to assign new designs to units garrisoned along the Periphery to guard against pirate attacks. Since the tentative peace won on Tukayyid, most new 'Mechs are now being tested on border worlds against the enemy for which they are intended.

Breaking with this new policy, the Federated Commonwealth has decided to test some of their newer designs in what remains of the Periphery to maintain secrecy around these developments until they are perfected. The *Dart* has been assigned to several light and medium Federated Commonwealth 'Mech units, with encouraging results reported.

Variants:

The most common field variant replaces damaged small pulse lasers with standard medium lasers from existing stockpiles. This reduces the accuracy of the weapon and puts more of a demand on the *Dart*'s heat sinks, but many pilots feel that the longer range and increased damage potential are worth it.

Although the *Dart* is considered a success by Coventry Metal Works, units field-testing the new 'Mech cite the 'Mech's lack of armor as a critical design flaw. Coventry is rumored to be working on a variant that sacrifices the lasers in favor of increased armor. If this variant is successful, the original design may be phased out.

Type: Dart
Technology Base: Inner Sphere
Tonnage: 25

Equipment		Mass
Internal Structure:		2.5
Engine:	225	10
Walking MP:	9	
Running MP:	14	
Jumping MP:	0	
Heat Sinks:	10	0
Gyro:		3
Cockpit:		3
Armor Factor:	56	3.5

	Internal Structure	Armor Value
Head	3	6
Center Torso	8	7
Center Torso (rear)		3
R/L Torso	6	7
R/L Torso (rear)		3
R/L Arm	4	5
R/L Leg	6	5

Weapons and Ammo	Location	Critical	Tonnage
Small Pulse Laser	H	1	1
Small Pulse Laser	CT	1	1
Small Pulse Laser	CT	1	1

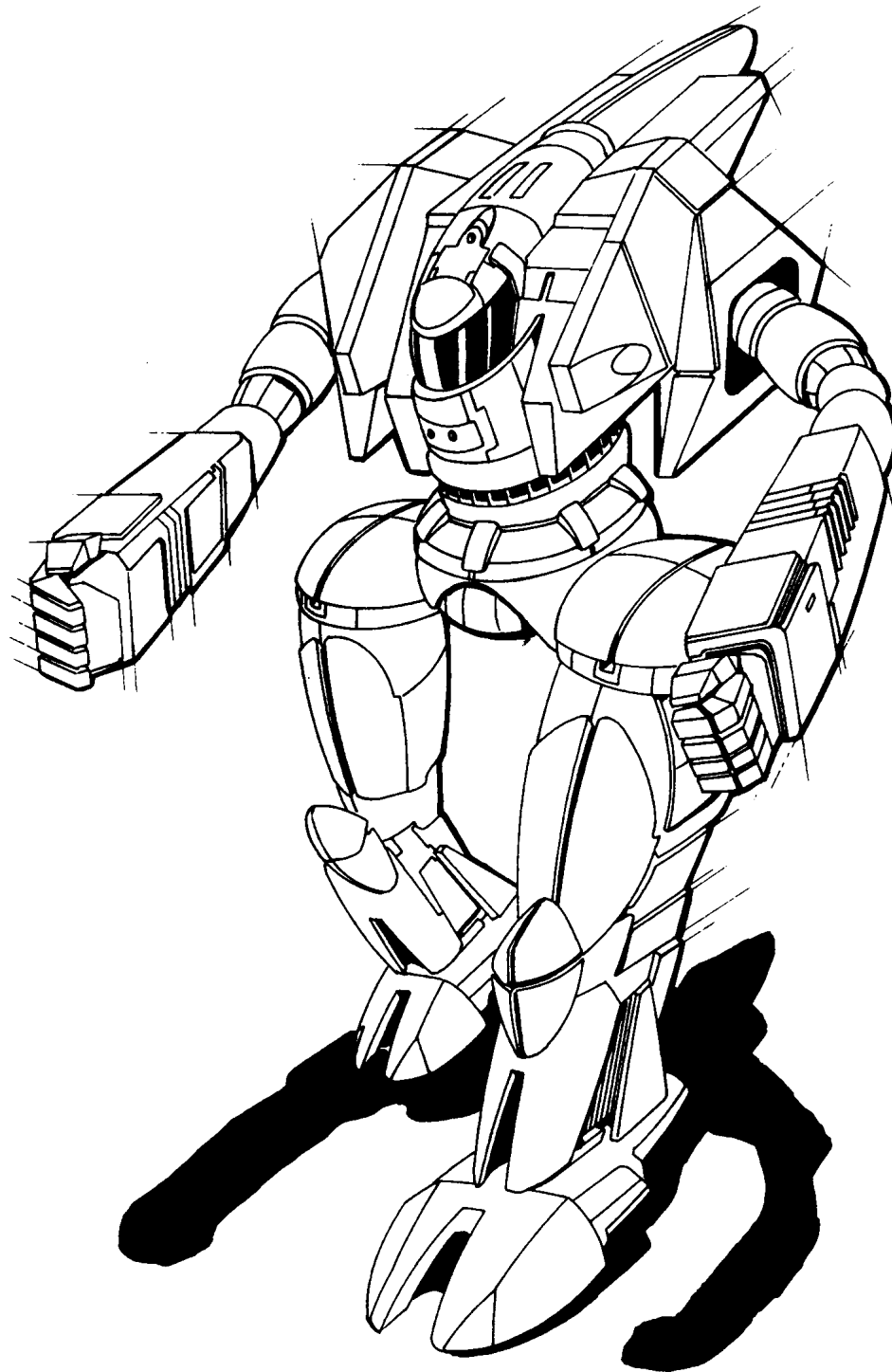

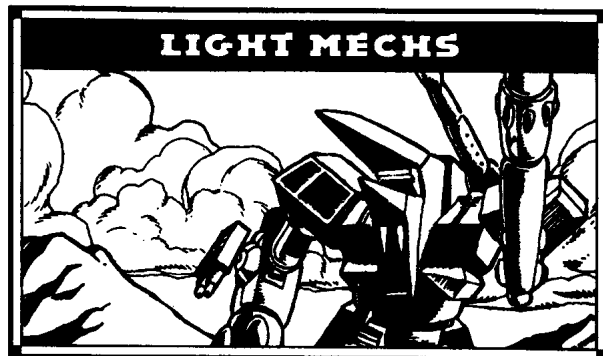

Mass: 25 tons
Chassis: Corean IX
Power Plant: Nissan 200 XL
Cruising Speed: 86.4 kph
Maximum Speed: 130 kph
Jump Jets: Rawlings 75
Jump Capacity: 240 meters
Armor: StarSlab/2
Armament:
 1 Hovertec Streak SRM-2 Rack
 2 Magna Mark II Medium Lasers
Manufacturer: Corean Enterprises,
 MacAdams-Suharno
Primary Factory: Stewart
Communications System: Garret T10B
Targeting and Tracking System: Corean CalcMaster

Overview:

The recent success of the GOL-3M *Goliath* has prompted Corean Enterprises to take another look at four-legged 'Mech designs. In an effort to avoid the kind of problems shown by the poorly regarded *Scorpion*, the designers decided on an entirely new purpose for the quad chassis. Intended to serve as a light recon 'Mech, the *Tarantula* is the first four-legged design to mount jump jets.

Capabilities:

Corean designers decided to take advantage of the stability and maneuverability provided by a four-legged chassis to build an extremely agile recon 'Mech. The

resulting design combined the squat, four-legged look of the *Scorpion* with the sleek lines of the *Mercury*.

A primary concern was to improve the pilot's comfort, since quad 'Mechs are notorious for giving MechWarriors a bumpy ride. Care was given to enlarging the cockpit and to installing a special seat that helps negate the jarring bounces that occur whenever the *Tarantula* crests a hill. The 'Mech's legs are equipped with sophisticated shock absorbers, which not only smooth the ride, but help absorb the enormous impact of a 240-meter jump.

The *Tarantula*'s armor protection is good for a 'Mech of its size, and also spread more evenly around the front and back than is usual. In addition, the 'Mech's legs are heavily armored and reinforced to prevent loss of the limbs during battle or landing.

The *Tarantula*'s primary weapons are two Magna Mark II medium lasers, mounted in raised pods on the upper surface of the left and right torso. The *Tarantula* also sports a Hovertec Streak SRM-2 missile rack in the center torso, directly below the cockpit.

All the test pilots have commented on the noticeably comfortable ride, improved stability, and handling. In fact, once a pilot grows accustomed to the four-legged differences, the *Tarantula* is clearly superior to a bipedal 'Mech of similar specifications, such as the *Spider*.

Naturally, there are many skeptics who doubt that a four-legged design can ever compete with the more traditional 'Mechs. Old habits die hard, and it will be difficult for most MechWarriors to drop preconceived notions based on the old *Scorpion* design. Those who can will discover a startling new 'Mech of unsurpassed agility and a low profile particularly well-suited to recon and surveillance.

Deployment:

Because of this 'Mech's unusual nature, many pilots simply will not accept an assignment to it, preferring instead to enter the ranks of the Dispossessed. With this in mind, the *Tarantula* is assigned on a purely voluntary basis. Unit commanders are offered the 'Mech, and they consult with their men for volunteers. Corean's public relations department is busy working

out a promotional holovid for distribution to appropriate units, utilizing actual battle footage and MechWarrior testimonials. It may take a long time, but Corean hopes to eventually erase the *Scorpion* from the minds of pilots, and replace it with the *Tarantula*.

Type: Tarantula

Technology Base: Inner Sphere

Tonnage: 25

Equipment		Mass
Internal Structure:		2.5
Engine:	200 XL	4.5
Walking MP:	8	
Running MP:	12	
Jumping MP:	8	
Heat Sinks:	10 [20]	0
Gyro:		2
Cockpit:		3
Armor Factor:	72	4.5
	<i>Internal Structure</i>	<i>Armor Value</i>
Head	3	6
Center Torso	8	10
Center Torso (rear)		6
R/L Torso	6	7
R/L Torso (rear)		4
R/L Arm	4	7
R/L Leg	6	7

Weapons and Ammo	Location	Critical	Tonnage
Streak SRM 2	CT	1	1.5
Ammo (Streak) 50	CT	1	1
Medium Laser	RT	1	1
Medium Laser	LT	1	1
Jump Jets	RA	2	1
Jump Jets	LA	2	1
Jump Jets	RL	2	1
Jump Jets	LL	2	1

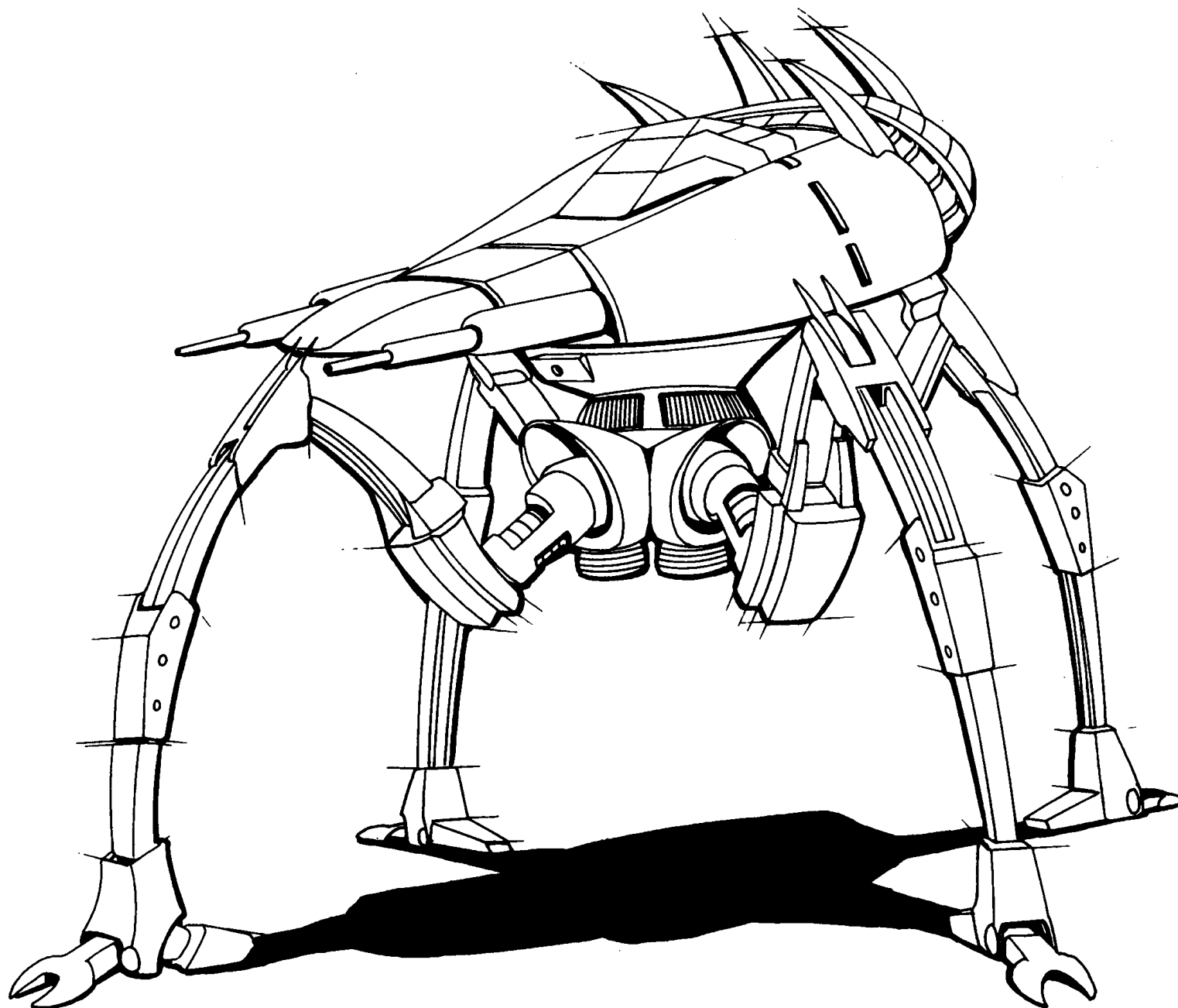

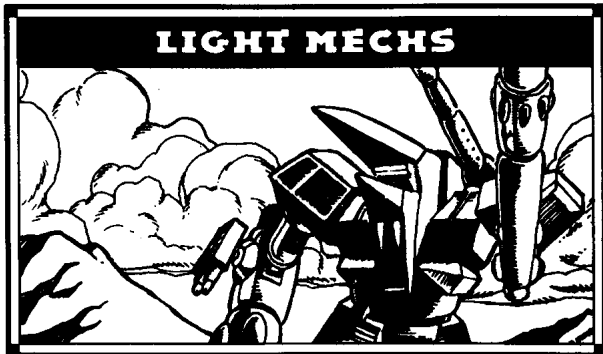

Mass: 30 tons
Chassis: Maltex 40
Power Plant: GM 150 XL
Cruising Speed: 54 kph
Maximum Speed: 86 kph
Jump Jets: Luxor 2/Q
Jump Capacity: 150 meters
Armor: Paulina Heavy Ferro-Fibrous
Armament:
 1 McArthur Anti-Missile System
 1 Hovertec Streak SRM-2 Rack
 3 Defiance P5M Medium Pulse Lasers
Manufacturer: Defiance Industries
Primary Factory: Hesperus II
Communications System: TharHes Thalia HM-22
Targeting and Tracking System: TharHes Ares-5B

Overview:

Defiance Industries, once considered the Inner Sphere's premier BattleMech engineering and construction firm, has recently found itself regularly out-classed and outproduced by the Free Worlds League. In a bold move, Defiance has dramatically upscaled the Hesperus II works facilities, including the addition of a new production line dedicated to the *Battle Hawk*.

Given the severe blow the Clan invasion dealt to the Federated Commonwealth economy, many consider the staggering risk of this venture to verge on the insane. Many engineers and MechWarriors also question the quality of the *Battle Hawk's* construction because of the great haste that went into initiating production.

Capabilities:

The *Battle Hawk* was originally conceived as a relatively slow light 'Mech designed for medium-range fighting. The coupling of the recently recovered Star League-era McArthur anti-missile system and the Defiance pulse laser systems was believed to be unstoppable. In trial runs the stout-profiled *Battle Hawk* proved easy to handle and deadly against mock targets.

The design team noticed that most of the Federated Commonwealth's 'Mechs lacked armor heavy enough to survive long encounters with the Clan forces so they concentrated on providing the *Battle Hawk* with enough armor to allow it to bring its respectable firepower to bear.

An interesting feature of the *Battle Hawk* is that all of its weapons are arm-mounted. Like the *Hatchetman*, the *Battle Hawk* is equipped with a full-head ejection system, making it popular with MechWarriors assigned to hostile environments.

Deployment:

Eager to prove that its newest designs would usher in a new era for the battered Federated Commonwealth, Defiance Industries pressured the military to use several lances of the still prototypical 'Mech for a combat mission. Two lances of *Battle Hawks* were sent to the recently redeployed First Robinson RCT, assigned to a raiding mission into the Clan Occupation Zone.

Battle Hawk losses were minimal, and almost all the MechWarriors who piloted them reported their performance to be exceptional. Unfortunately, the mission itself was a poorly executed disaster that ended in an ignominious rout. General Nowack, desperate to deflect blame away from his own troops, announced publicly that the use of the "untested" *Battle Hawk* contributed to their defeat.

The public relations experts at Defiance Industries attempted to suppress the negative publicity that resulted from this incident, but to no avail. The *Battle Hawks* already ordered by the Federated Commonwealth have been reassigned to shore up undermanned garrisons.

Type: **Battle Hawk**

Technology Base: Inner Sphere

Tonnage: 30

Equipment

Internal Structure:		3
Engine:	150 XL	3
Walking MP:	5	
Running MP:	8	
Jumping MP:	5	
Heat Sinks:	11 [22]	1
Gyro:		2
Cockpit:		3
Armor Factor:	99	5.5

	Internal Structure	Armor Factor
Head	3	9
Center Torso	10	16
Center Torso (rear)		4
R/L Torso	7	11
R/L Torso (rear)		3
R/L Arm	5	9
R/L Leg	7	12

Weapons and Ammo	Location	Critical	Tonnage
Anti-Missile System	H	1	.5
Ammo (Anti-Missile) 12	CT	1	1
Streak SRM 2	LA	1	1.5
Ammo (Streak) 50	LA	1	1
Medium Pulse Laser	RA	1	2
Medium Pulse Laser	RA	1	2
Medium Pulse Laser	RA	1	2
Jump Jets	RL	2	1
Jump Jets	LL	2	1
Jump Jet	CT	1	.5

BH-305 BATTLE HAWK

LIGHT 'MECHS

17

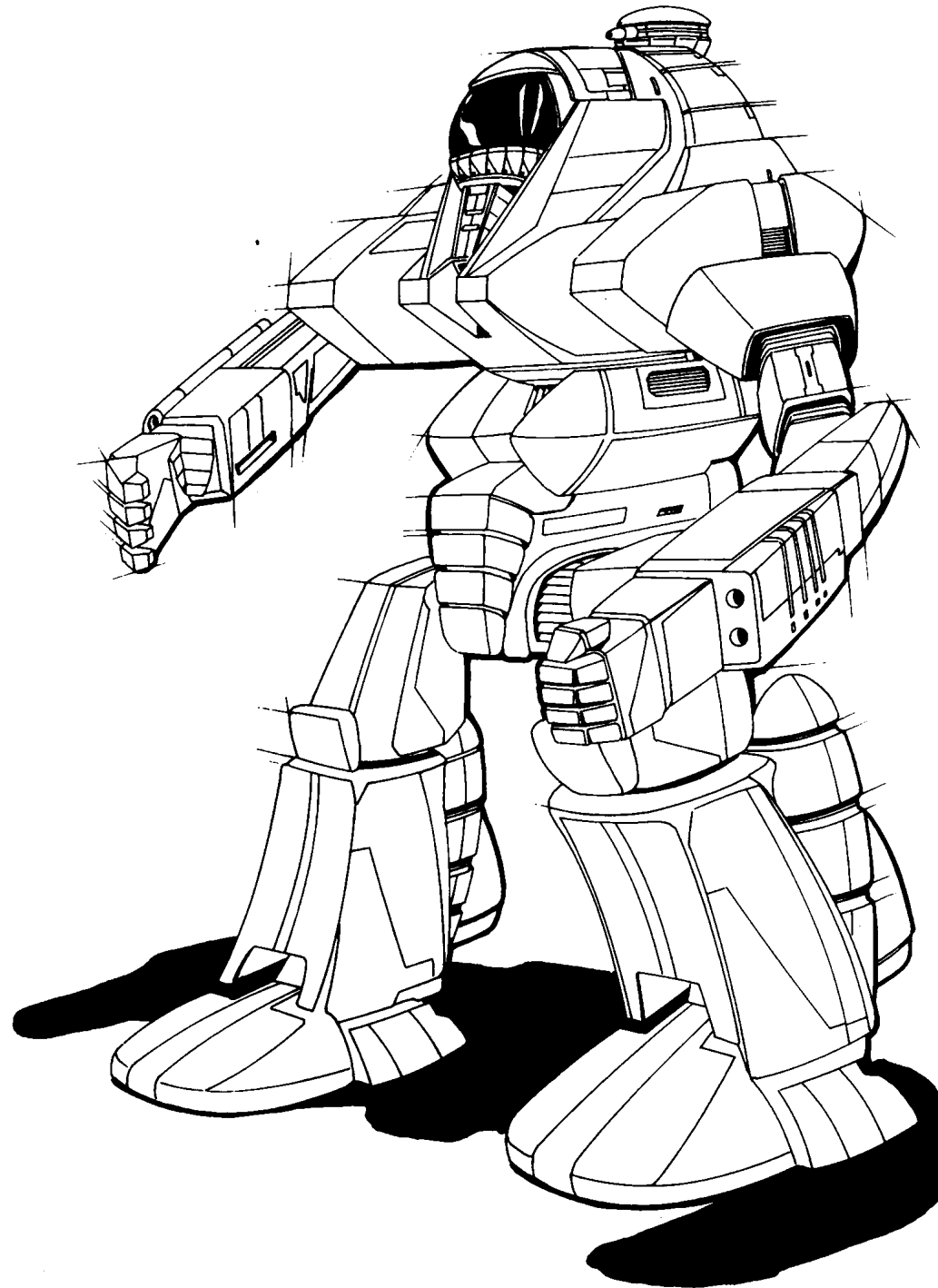

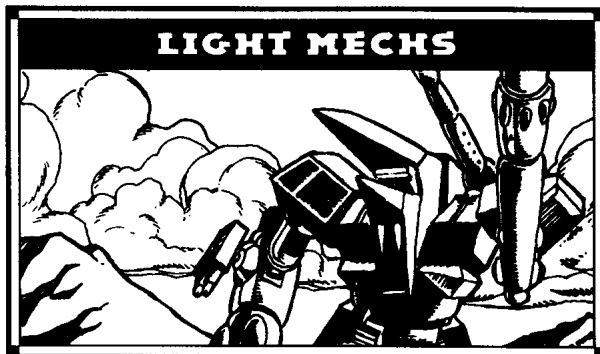

Mass: 30 tons
Chassis: Duralyte 299 Endo Steel
Power Plant: GM 150
Cruising Speed: 54 kph
Maximum Speed: 81 kph
Jump Jets: None
 Jump Capacity: None
Armor: Jolassa-325
Armament:
 2 Coventry LRM-5 Racks
 3 Martell Medium Lasers
Manufacturer: Free Worlds Defense Industries
 Primary Factory: Gibson
Communications System: Datacom 50
Targeting and Tracking System: Dynatec 1122

Overview:

The leaders and high military commanders of the Free Worlds League have been awaiting the day when the Inner Sphere powers would shift their focus from their mutual Clan enemy to fighting among themselves once more. Seeking to be prepared for that day, the FWL military commissioned Free Worlds Defense Industries to design and produce a BattleMech that could effectively counter the Federated Commonwealth's *Valkyrie* design.

Capabilities:

The *Hammer* boasts twin LRM-5s, each with Artemis fire control systems for better accuracy. Each LRM rack is equipped with enough ammunition to

launch 24 salvos in combat. Three medium lasers complement the long-range missiles. The medium lasers are the tried-and-true Martell design that is known throughout the Inner Sphere.

The *Hammer's* top speed of 81 kph matches the top running speed of the *Valkyrie*. Because the 'Mech was specifically designed to counter the *Valkyrie*, this was a necessity. The only argument for a lower speed was quickly eliminated when the engineers tested jump jets and found that the stress on the BattleMech's frame was beyond acceptable parameters.

Because of that testing, however, the engineers decided to use endo steel. The savings of weight from the infrastructure allowed the placement of more armor over the volatile missile surfaces on the 'Mech's torso. The communications system is also a well-tested one: the Datacom 50, in use throughout the Inner Sphere, especially in the Free Worlds League.

The *Hammer* has been paired with another new design, appropriately known as the *Anvil*, and together they are being tested in combat simulations on Gibson.

Deployment:

The Duchy of Andurien has suffered in recent history from rebellious officials, pirate raids, and invasions by neighboring forces. Once the Free Worlds government began to assert its control over the Duchy more effectively, the decision was made to field test new 'Mech designs in this arena.

All units at the edge of Free Worlds space have been assigned some of the new designs.

The *Hammer* has proven effective at providing long-range covering fire to companies of lighter 'Mechs who routinely have no substantial missile cover in combat situations. The *Hammer*, while not having anything like the firepower of the *Archer* (also commonly used for fire support) can still force an opponent into a disadvantageous position.

Variants:

The variant most frequently spotted is nicknamed the *Slammer*. In this version the 'Mech's missile ammo is doubled at the expense of two of the three medium

lasers, for use in extended operations behind enemy lines. *Slammer* conversion requires prohibitive time and manpower, and so is relatively rare.

Type: Hammer

Technology Base: Inner Sphere

Tonnage: 30

Equipment

Equipment		Mass
Internal Structure:	Endo Steel	1.5
Engine:	150	5.5
Walking MP:	5	
Running MP:	8	
Jumping MP:	0	
Heat Sinks:	11	1
Gyro:		2
Cockpit:		3
Armor Factor:	96	6

	Internal Structure	Armor Value
Head	3	9
Center Torso	10	14
Center Torso (rear)		5
R/L Torso	7	11
R/L Torso (rear)		3
R/L Arm	5	10
R/L Leg	7	10

Weapons and Ammo	Location	Critical	Tonnage
LRM 5	LT	1	2
Ammo (LRM) 24	LT	1	1
Artemis IV FCS	LT	1	1
LRM 5	RT	1	2
Ammo (LRM) 24	RT	1	1
Artemis IV FCS	RT	1	1
Medium Laser	H	1	1
Medium Laser	CT	1	1
Medium Laser	CT	1	1

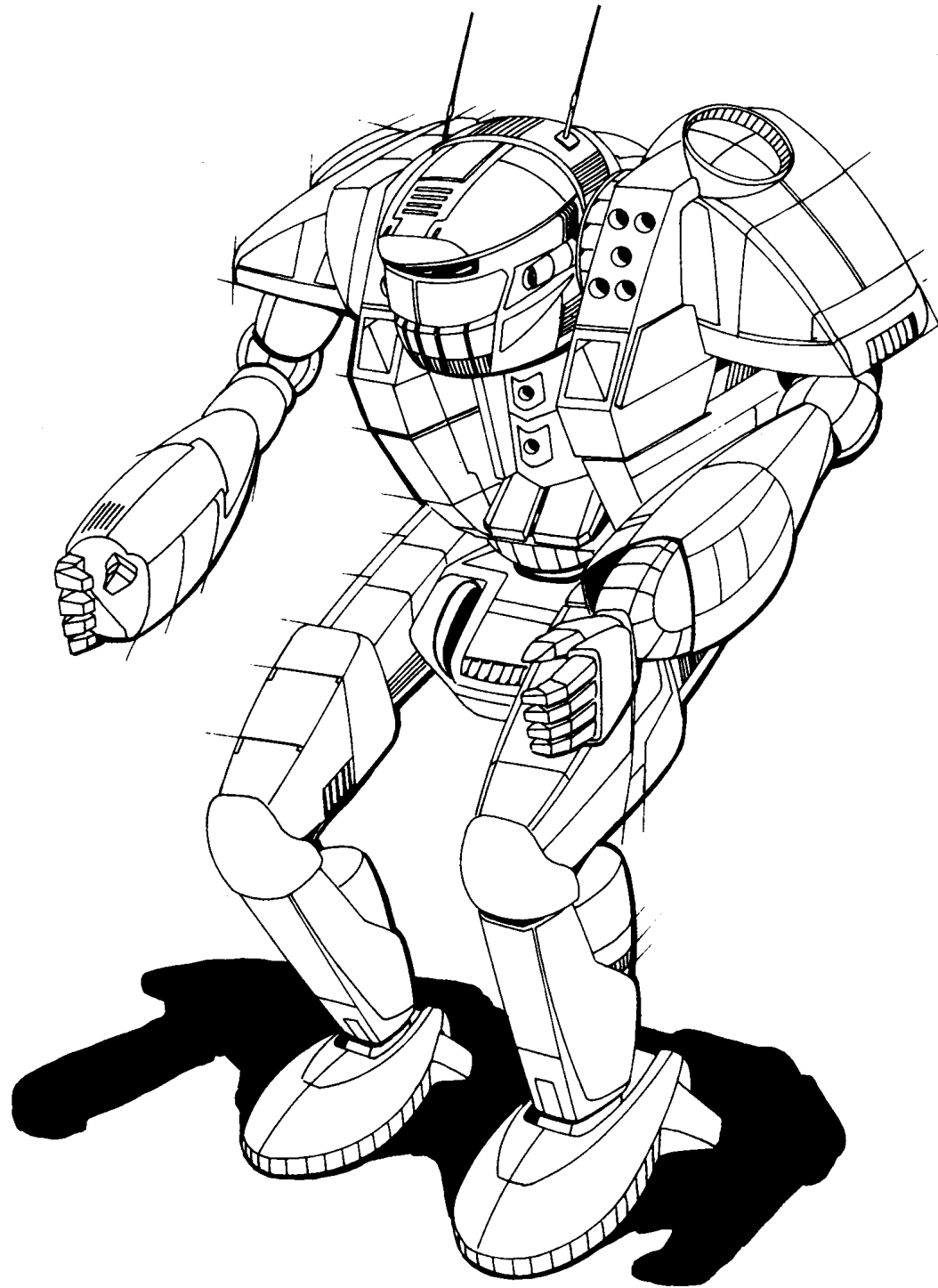

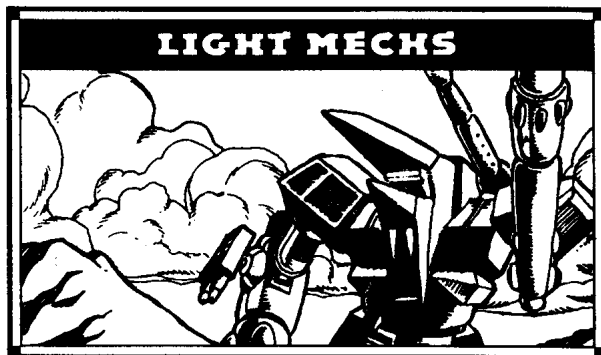

Mass: 30 tons

Chassis: Chariot Type 1

Power Plant: GM 210 XL

Cruising Speed: 75 kph

Maximum Speed: 119 kph, w/MASC 151 kph

Jump Jets: None

Jump Capacity: None

Armor: Starshield A

Armament:

1 Thunderstroke-L LRM-5 Rack

3 Argra 3L Medium Lasers

Manufacturer: Diplan 'Mechyards

Primary Factory: Ozawa

Communications System: Sipher CommCon SCU-4 with Guardian ECM Suite

Targeting and Tracking System: Cat's Eyes 5 with Forward-1 and Artemis IV Fire Control System

Overview:

With the arrival of the Clans, the formidable armies of both the Draconis Combine and the Federated Commonwealth more than met their match. As regiment after regiment was lost, the leaders of the two realms saw the need to adopt new tactics to counter the technological advantages of the Clans. Some of these tactics led to the creation of the HM-1 *Hitman* by the Draconis Combine.

Capabilities:

The *Hitman* is an extremely agile and fast light 'Mech, capable of speeds of up to 118.8 kph. The

'Mech also features the MASC system, which allows bursts of speed well over 150 kph.

To ensure success of the *Hitman's* primary purpose, which is to sneak up on enemy units undetected, a Guardian ECM suite was installed. Because the Combine's ability to produce high-quality electronic gear is still somewhat limited, House Kurita had to contract with a Free Worlds League manufacturer to obtain this crucial component.

Once the *Hitman* is within range of an enemy, the 'Mech's Beagle Active Probe can help to identify both the class and the type of equipment. The Beagle Active Probe has also proven valuable in minimizing the *Hitman's* vulnerability to ambush.

If the *Hitman* is intercepted, it can use its advantage of speed to escape, even from most Clan 'Mechs. With such a 'Mech, the pilot is always free to get away and fight from a more advantageous position.

The *Hitman's* most important role is accomplished with its target-acquisition gear, which produces a rain of accurate and deadly fire against an enemy target. By transmitting coordinates directly to the fire control of artillery pieces, human error is considerably reduced.

Once the *Hitman* locates a target, it paints it with the TAG system, allowing the incoming Arrow IV missiles to lock on for the kill. This method of attack earned the 'Mech its name. To ensure survival after contact with enemy units, the 'Mech also has a trio of medium lasers and an LRM-5 rack. The accuracy of the LRM is increased by the addition of an Artemis IV fire control system.

Many have speculated that the *Hitman* is really a modified copy of the Capellan *Raven*, since both 'Mechs pack a wide array of high-tech electronics. However, the *Hitman's* exterior and design more resemble the shapes of the Draconis Combine's *Panther* or the Federated Commonwealth's *Wolfhound* and *Valkyrie*.

Deployment:

The *Hitman* is still being tested on the training grounds of the Sun Zhang Academy on New Samarkand.

Over a dozen 'Mechs of this class have been involved in large-scale military exercises conducted by

the DCMS and Sun Zhang Academy pilots. As battalion-sized units squared off in the ruins and rural areas, these training exercises tested all possible uses of the new equipment. Both traditional and newly developed tactics were pitted against those used by the Clans.

Intelligence experts predict that the *Hitman* will be deployed when Arrow IV-equipped 'Mechs or vehicles become available in large quantities. The units stationed on Wolcott, deep within Clan-occupied territory, will surely be the first to receive the *Hitman* and its "guns."

Type: **Hitman**

Technology Base: Inner Sphere

Tonnage: 30

Equipment		Mass
Internal Structure:	Endo Steel	1.5
Engine:	210 XL	4.5
Walking MP:	7	
Running MP:	11 (14)	
Jumping MP:	0	
Heat Sinks:	10	0
Gyro:		3
Cockpit:		3
Armor Factor:	80	5
	<i>Internal Structure</i>	<i>Armor Value</i>
Head	3	8
Center Torso	10	10
Center Torso (rear)		6
R/L Torso	7	8
R/L Torso (rear)		4
R/L Arm	5	7
R/L Leg	7	9

Weapons and Ammo	Location	Critical	Tonnage
Guardian ECM Suite	LT	2	1.5
MASC	RL	2	2
Beagle Active Probe	RT	2	1.5
LRM 5	LT	1	2
Artemis IV FCS	LT	1	1
Ammo (LRM) 24	LT	1	1
Medium Laser	LA	1	1
Medium Laser	LA	1	1
Medium Laser	LA	1	1
TAG	H	1	1

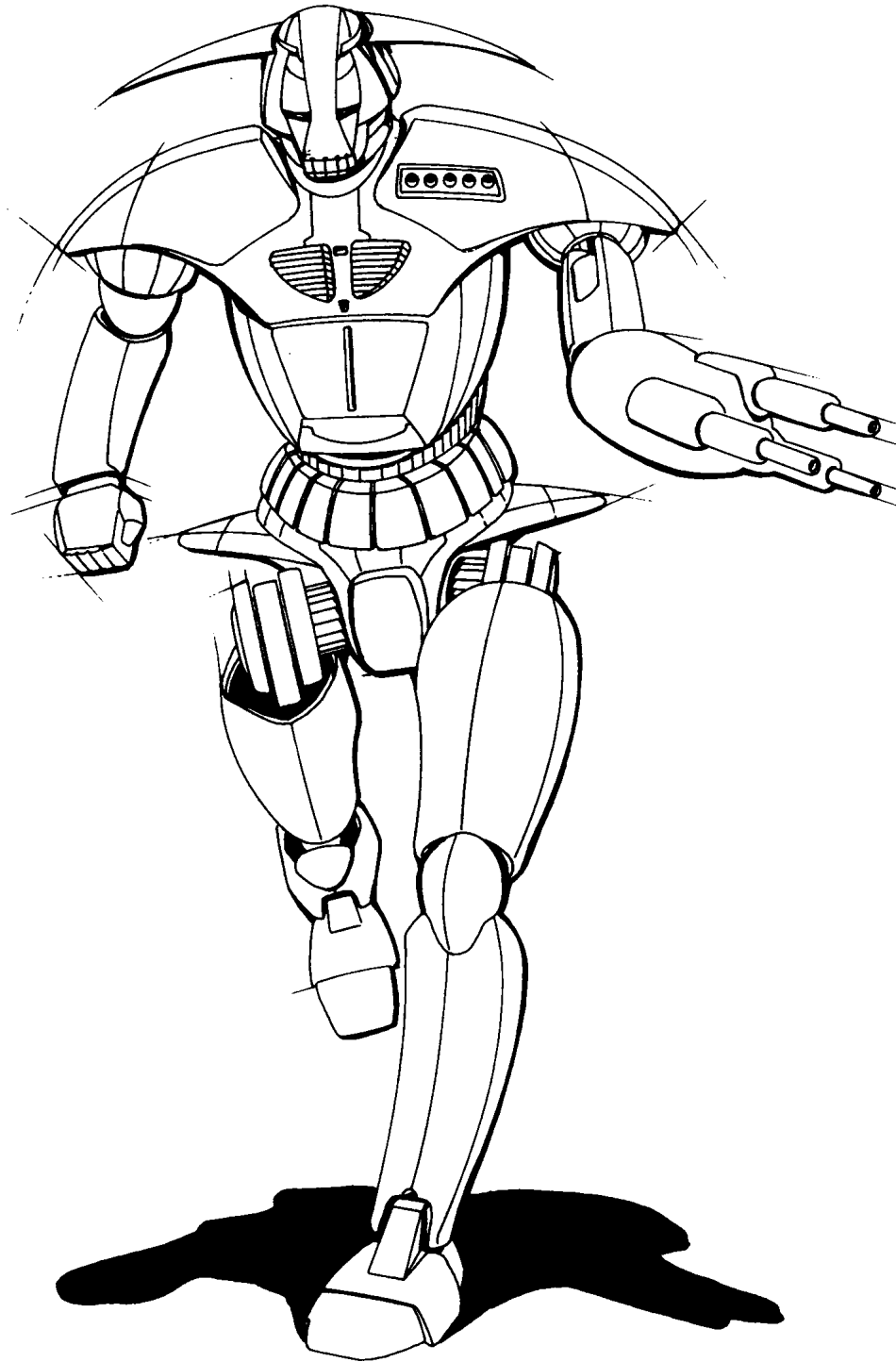

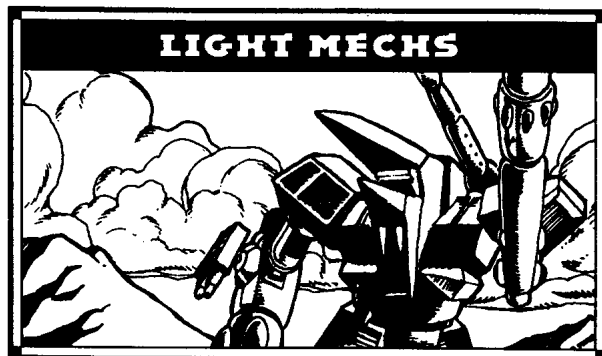

Mass: 30 tons
Chassis: Hollis Mark VI - Alpha (Endo Steel)
Power Plant: GM 210 XL
Cruising Speed: 75.6 kph
Maximum Speed: 118.8 kph
Jump Jets: None
Jump Capacity: None
Armor: York Industries CTC-0
Armament:
 1 Aberdovey Mark XXX Extended Range PPC
 1 Burow Anti-Missile System
 1 Holly Streak SRM-2 Rack
Manufacturer: Earthwerks
Primary Factory: Keystone
Communications System: Sipher Security Plus
Targeting and Tracking System: Hartford S2000A

Overview:

The *Jackal* was designed by the now famous Vining Engineering and Salvage Team (VEST) in conjunction with Marik's Earthwerks BattleMech factory on Keystone. VEST began as a five-person BattleMech salvage operation on Solaris VII and in seven months has grown into one of the most innovative design groups for battlefield technology in the Inner Sphere.

The key to Vining Engineering's approach is that the designers study and analyze the combat conditions up close, then engineer to meet the needs of the MechWarriors. In reviewing Clan tactics during the initial wave of attacks on Carse and Nox, the design team determined that 'Mechs capable of inflicting concen-

trated damage at long range would be the most useful to Inner Sphere commanders.

Capabilities:

For the structure of the *Jackal*, VEST used a prototype Hollis Mark VI endo steel frame as the basis for their design. Drawing on first-hand experience of the Clans gained through salvaging operations, the engineers tackled the problem of manufacturing a hard-hitting BattleMech with the armor and defenses to hang in for a prolonged fight against superior Clan firepower.

In order to sell their design, VEST offered it to a promising new stable on Solaris VII, where the 'Mech took part in several matches. The *Jackal* proved to be a deadly hunter 'Mech. With speed and firepower equally balanced, it was able to slowly chew away at its opposition before the enemy could close for a kill. Earthwerks was so impressed with the 'Mech's performance that they purchased the design immediately.

The core of the *Jackal's* firepower is the Aberdovey Mark XXX extended-range PPC. Mounted in the 'Mech's upper right shoulder, the weapon has proved easy to service. Rather than waste space on static discharge coil systems, the VEST designers simply allowed for rear discharge; when the *Jackal* fires its PPC, there is a blast of blue static electricity out of the back of the 'Mech to the rear of the PPC mount. Though it is not dangerous, the rear discharge is a menacing sight, silhouetting the *Jackal* during night operations.

Deployment:

Quite a few of these new BattleMechs have been sold to House Liao and deployed along their Periphery border with the Magistracy of Canopus. In the very limited engagements occurring there, the *Jackal* has served as a highly effective deterrent to the typical Periphery border raiders/pirates.

The Federated Commonwealth has also expressed interest in procuring a shipment of *Jackals*, but their order has been delayed by the notorious tangle of red tape created by the Free Worlds League's bureaucracy. MIO operatives believe that the delays

are intentional rather than coincidental. According to unofficial sources, the *Jackal* was designed to be a commodity shared only by Houses Liao and Marik.

Type: **Jackal**

Technology Base: Inner Sphere

Tonnage: 30

Equipment

		Mass
Internal Structure:	Endo Steel	1.5
Engine:	210 XL	4.5
Walking MP:	7	
Running MP:	11	
Jumping MP:	0	
Heat Sinks:	11	1
Gyro:		3
Cockpit:		3
Armor Factor:	96	6
	Internal Structure	Armor Factor
Head	3	8
Center Torso	10	15
Center Torso (rear)		5
R/L Torso	7	10
R/L Torso (rear)		4
R/L Arm	5	8
R/L Leg	7	12

Weapons and Ammo

	Location	Critical	Tonnage
ER PPC	RT	3	7
Anti-Missile System	H	1	.5
Ammo (Anti-Missile) 12	CT	1	1
Streak SRM 2	LA	1	1.5
Ammo (Streak) 50	LT	1	1

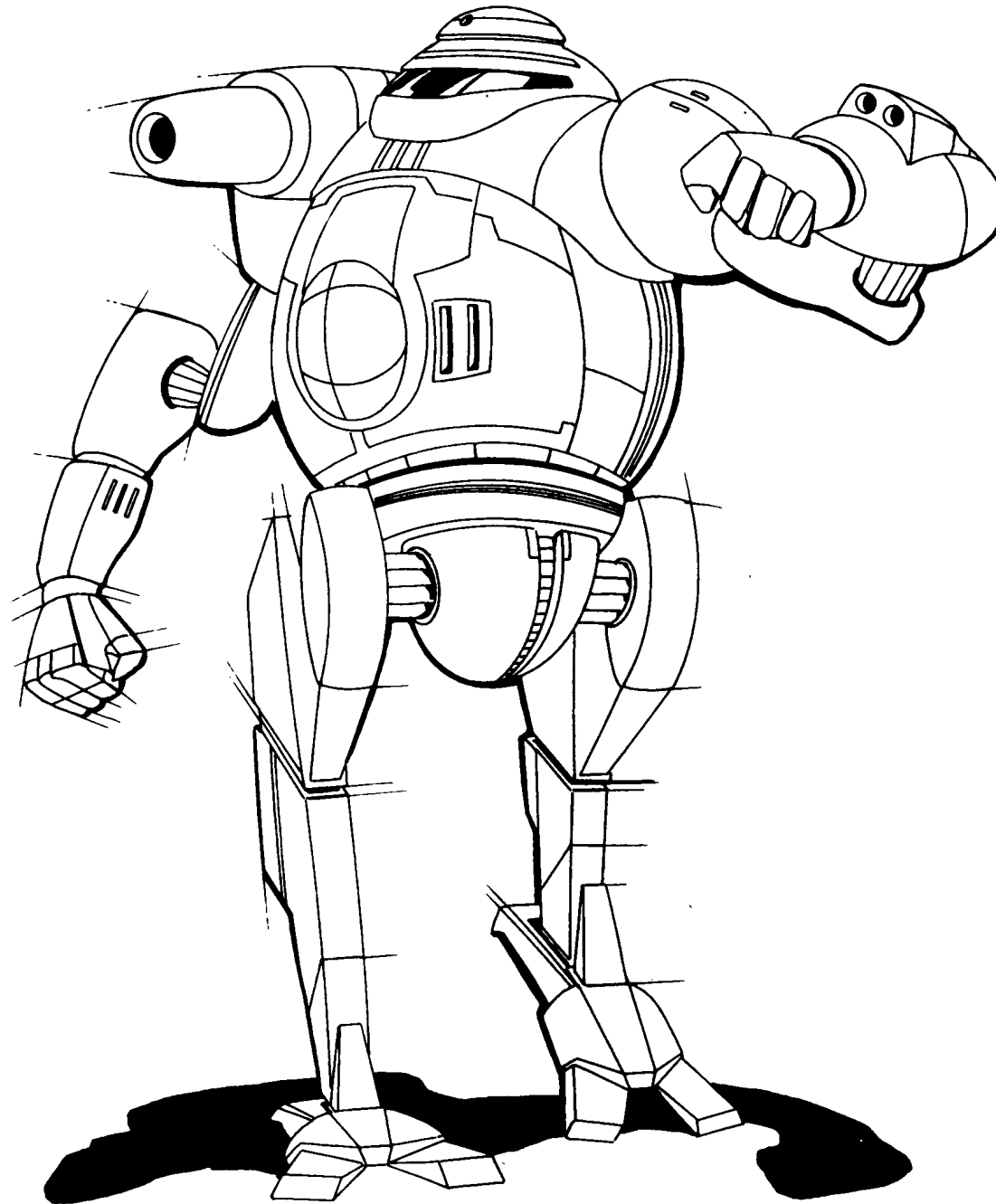

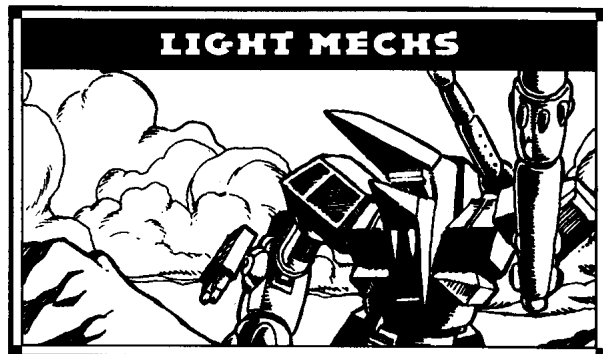

Mass: 30 tons

Chassis: Small Bug-B

Power Plant: Vlar 300 XL

Cruising Speed: 108 kph

Maximum Speed: 162 kph

Jump Jets: None

Jump Capacity: None

Armor: Valiant Gauntlet Ferro-Fibrous

Armament:

2 Defiance B3M Medium Lasers

2 Defiance B3S Small Lasers

Manufacturer: Coventry Metal Works

Primary Factory: Coventry

Communications System: Winston Silicon Siren

Targeting and Tracking System: Winston

Coral Snake with CherrySeed Bullseye Target Acquisition Gear

Overview:

Intended for use as a scout/recon and forward-observer 'Mech, the SCB-9A *Scarabus* is a showpiece of Federated Commonwealth technology and know-how that combines many rediscovered technologies with some new innovations.

Capabilities:

The design specifications for the *Scarabus* called for a 'Mech that could outrun and outshoot a *Locust*, objectives that would be nearly impossible without Star League technology. Unlike the *Commando*, on which the design was based, the *Scarabus* was meant to survive extensive action behind enemy lines.

Mindful of the extended periods of isolated operation required by its intended role as a recon 'Mech and the dangers posed by weapons that require ammunition, the designers restricted the *Scarabus* to beam-technology weapons.

The symmetrical laser pods on the *Commando's* arms were combined on the left arm for the *Scarabus* design. Unfortunately, the complex power coupling for the so-called "quad-pod" arrangement disconnects if the housing is jarred excessively. Field technicians have learned to control this problem by fusing the coupling, which makes repairs more difficult but stabilizes the unit.

The design was rounded out with a small hatchet on the right arm for use in close combat and a Guardian ECM suite. The hatchet was included as a compromise to make the *Scarabus* more appealing to the lucrative Solaris market.

Deployment:

Owing to the tensions along the Clan border, the *Scarabus* 'Mechs currently in production have already been assigned to key defensive worlds and will be deployed as quickly as they can be manufactured. It is believed that Clan Jade Falcon will attempt punitive raids on readily accessible worlds such as Barcelona, Kikuyu, and Pasig. Garrison units stationed on these "hot spots" are in desperate need of reliable recon 'Mechs and are clamoring for the new design.

Variants:

Rumors abound that the Federated Commonwealth has converted many of their *Scarabus* 'Mechs to triple-strength myomer technology.

The VEST designers added a hatchet to the *Scarabus* because they hoped to market the 'Mech for the Solaris Games to recoup their huge investment. When the Solaris VII fad of adding blades and claws became a huge success, several variants were cobbled together with an assortment of experimental melee weapons, most of dubious value.

Type: **Scarabus**

Technology Base: Inner Sphere

Tonnage: 30

Equipment

		Mass
Internal Structure:	Endo Steel	1.5
Engine:	300 XL	9.5
Walking MP:	10	
Running MP:	15	
Jumping MP:	0	
Heat Sinks:	10	0
Gyro:		3
Cockpit:		3
Armor Factor:	99	5.5

	Internal Structure	Armor Value
Head	3	9
Center Torso	10	12
Center Torso (rear)		6
R/L Torso	7	10
R/L Torso (rear)		4
R/L Arm	5	9
R/L Leg	7	13

Weapons and Ammo	Location	Critical	Tonnage
Guardian ECM Suite	CT	2	1.5
Medium Laser	LA	1	1
Medium Laser	LA	1	1
Small Laser	LA	1	.5
Small Laser	LA	1	.5
Hatchet	RA	2	2
TAG	H	1	1

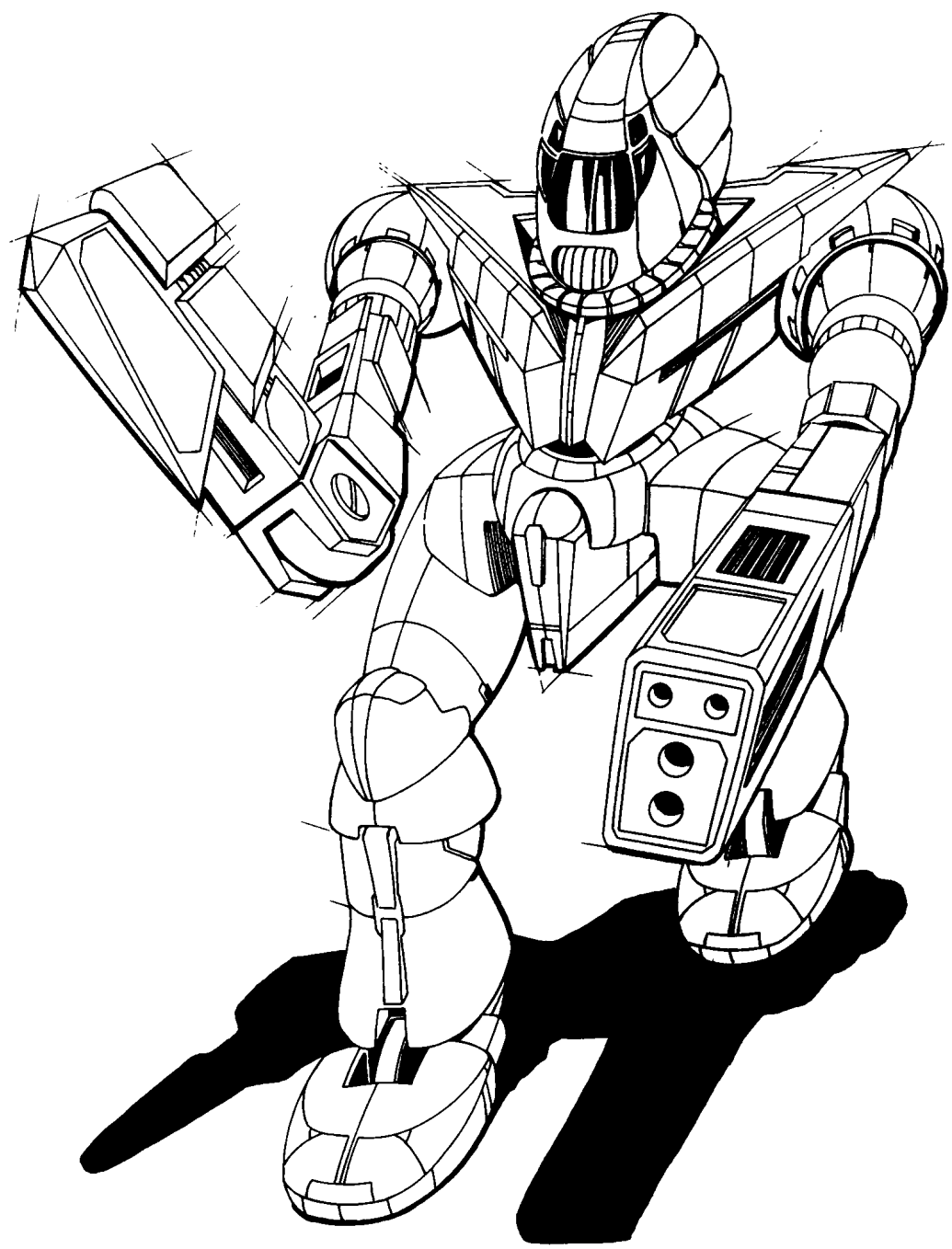

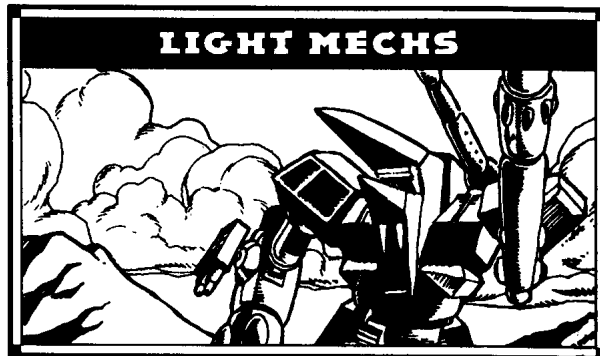

Mass: 35 tons
Chassis: Coventry BZK-III
Power Plant: Omni 175
Cruising Speed: 54 kph
Maximum Speed: 86.4 kph
Jump Jets: None
Jump Capacity: None
Armor: Lexington Ltd. High Grade Ferro-Fibrous
Armament:
 1 Poland Main Model A Gauss Rifle
Manufacturer: Coventry Metal Works
Primary Factory: Coventry
Communications System: TharHes Muse 54-58K
Targeting and Tracking System: Cyclops 9

Overview:

Faced with the superior range and firepower of the Clan invaders, the Steiner military wanted a light, fast 'Mech with superior long-range firepower. Many design firms offered plans featuring LRM racks and PPCs, but the contract went to Coventry Metal Works.

Their design, tagged the BZK-F3 *Hollander*, eliminated the heat buildup from PPCs and the danger of ammo explosion inherent in LRMs by mounting the massive Poland Main Model A Gauss rifle in the 'Mech's right torso. This unorthodox design would provide unprecedented firepower in a light 'Mech, enough to take down other light 'Mechs in one shot.

Capabilities:

Intended to engage light and medium 'Mechs at extreme range and eliminate them quickly, the *Hollander* mounts a single Gauss rifle around which the entire 'Mech is built. The Gauss rifle provides devastating firepower and range, but also poses some inherent design limitations.

The Gauss rifle is so heavy that the designers had to reduce the size of the original power plant to compensate. The final design runs at a maximum speed of 86 kph, which severely limits the 'Mech's ability to pursue other light 'Mechs and makes it difficult to mount an effective retreat if outnumbered or in need of ammunition. Space requirements limited ammo to sixteen shots for the rifle, and weight limitations forced designers to remove a medium laser from the design, so the 'Mech has no backup weapon.

Initial specifications also called for six tons of ferro-fibrous armor, giving the 'Mech very good coverage for its weight. After mounting the Gauss rifle, the designers found that the 'Mech could barely move and that the weapon had difficulty tracking. The engineers were forced back to the drawing board, and had to sacrifice armor coverage on the torso and arms in order to afford full articulation for the Gauss rifle. As a result, the 'Mech has a distinctive profile, as the Gauss rifle appears bigger than the *Hollander's* chassis.

Even with all these drawbacks, the *Hollander* remains a marvel of design. Its chassis combines an endo steel internal structure and ferro-fibrous armor, giving maximum protection for minimum weight. The 'Mech's legs are heavily reinforced to provide a stable fire platform for the Gauss rifle, which is fitted with recoil compensators and support hydraulics. The end result is essentially a running rifle, capable of accurate long-range barrages even while moving at top speed.

Deployment:

All of the *Hollanders* currently produced by Coventry Metal Works are being sent to the Pasig Operations Area along the Jade Falcon front. Units receiving *Hollanders* include the Seventeenth Skye Rangers stationed on Barcelona, and the First Kearney

Highlanders on Mogyorod. Commonwealth commanders have high hopes that the design will compete favorably with the Jade Falcons' *Uller* OmniMech.

Variants:

Many pilots have been dissatisfied with the *Hollander's* lack of a secondary weapon and poor armor coverage. Designers at Coventry are already working on a variant coded BZK-G1, which replaces the Gauss rifle with a Mydron Excel LB 10-X autocannon. This refit provides enough weight and space to mount a Defiance B3M medium laser in each arm and to add two more tons of ferro-fibrous armor. This difficult modification is not expected to advance beyond prototype stage for quite some time.

Type: **Hollander**

Technology Base: Inner Sphere

Tonnage: 35

Equipment		Mass
Internal Structure:	Endo Steel	2
Engine:	175	7
Walking MP:	5	
Running MP:	8	
Jumping MP:	0	
Heat Sinks:	10	0
Gyro:		2
Cockpit:		3
Armor Factor:	72	4
	<i>Internal Structure</i>	<i>Armor Value</i>
Head	3	8
Center Torso	11	10
Center Torso (rear)		4
R/L Torso	8	8
R/L Torso (rear)		3
R/L Arm	6	6
R/L Leg	8	8

Weapons and Ammo	Location	Critical	Tonnage
Gauss Rifle	RT	7	15
Ammo (Gauss) 16	CT	2	2

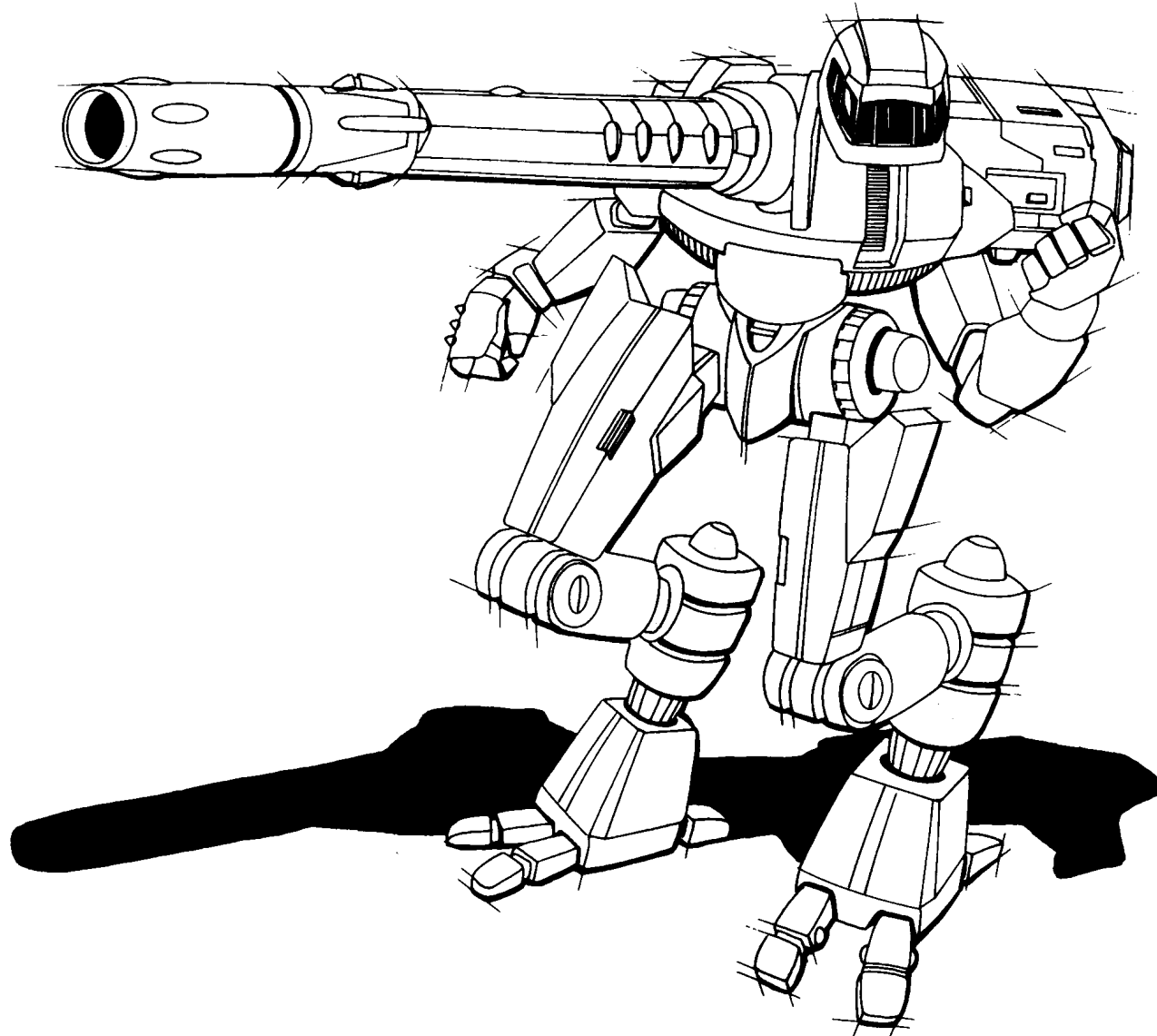

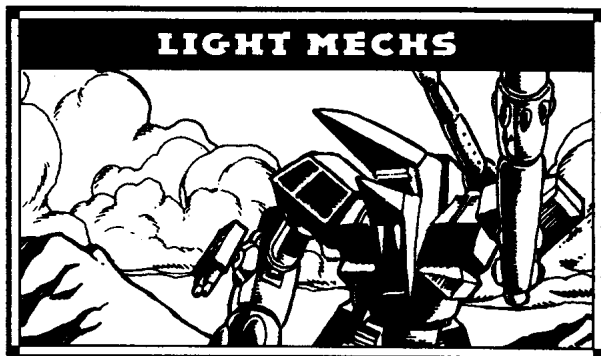

Mass: 35 tons
Chassis: Crucis-II, Newhart refit
Power Plant: Vox 280 XL
Cruising Speed: 86.4 kph
Maximum Speed: 130 kph
Jump Jets: Rawlings 75
Jump Capacity: 240 meters
Armor: Kallon FWL Special Ferro-Fibrous
Armament:
 4 Tronel XII Medium Pulse Lasers
Manufacturer: Nimakachi Fusion Products Ltd.
Primary Factory: Tematagi
Communications System: Omicron 4002
 Networking Channel
Targeting and Tracking System: TRSS Eagle Eye

Overview:

During the Clan invasion of Draconis Combine space, large numbers of Combine 'Mechs were destroyed in the fighting, with no chance of any salvage to support reconstruction. As a result, Coordinator Takashi Kurita ordered a massive production effort to replace the fallen units.

Nimakachi Fusion Products Ltd., a small manufacturer which had produced only *Spiders*, was forced to comply.

Eager to profit from the circumstances, the firm's owners decided that simple expansion of the *Spider* production lines would not guarantee future orders when the fighting slowed down. So a new design was sanctioned, with the limited resources available for the required expansion.

With an eye to future expansion, Nimakachi was eager to incorporate as much new and recovered technology as was available from the Draconis Combine. The *Venom* was born. The Combine military was so pleased with this design that it immediately placed an order for production of the *Venom* in large numbers.

Capabilities:

The *Venom* is a heavier version of the old *Spider* produced on Tematagi. It weighs 35 tons and uses Kallon FWL special ferro-fibrous armor. The new design also has an extralight engine, the Vox 280 XL, in order to keep space available for increased firepower. It's weapons are four new Tronel XII medium pulse lasers.

The movement capabilities of the *Venom* are identical to those of the original *Spider*. Since the phenomenal distances covered and the amount of control a pilot has during a jump were paramount in the original design, changes would have been counterproductive. Like its predecessor, the *Venom* is successful because of its maneuverability.

The *Venom* has two drawbacks that designers could not correct. First, the 'Mech's armor is light. The engineers are hoping that the design's movement capabilities are sufficient compensation. The second problem, which is compounded by the first, is the extralight engine. Any reasonable penetration into the left or right torso would more than likely penetrate the engine's shielding.

Deployment:

The first *Venom* came off the production line in January 3050, and has seen limited field testing so far. Theodore Kurita has seen fit to have all new designs sent to areas near the Periphery to protect the border against bandits and for potential punitive strikes. However, several of the new 'Mech designs have also been spotted patrolling worlds in Dieron, near the Terran frontier.

Variants:

Several field variants have been suggested by the manufacturer. The first removes a medium pulse laser in exchange for additional armor. The second variant is the more radical and calls for the removal of two of the jump jets and one pulse laser in exchange for a machine gun, ammo, a heat sink and additional armor.

Type: **Venom**
 Technology Base: Inner Sphere
 Tonnage: 35

Equipment		Mass
Internal Structure:		3.5
Engine:	280 XL	8
Walking MP:	8	
Running MP:	12	
Jumping MP:	8	
Heat Sinks:	12	2
Gyro:		3
Cockpit:		3
Armor Factor:	63	3.5
	<i>Internal Structure</i>	<i>Armor Value</i>
Head	3	8
Center Torso	11	7
Center Torso (rear)		4
R/L Torso	8	7
R/L Torso (rear)		3
R/L Arm	6	6
R/L Leg	8	6

Weapons and Ammo	Location	Critical	Tonnage
Medium Pulse Laser	LT	1	2
Medium Pulse Laser	LT	1	2
Medium Pulse Laser	RT	1	2
Medium Pulse Laser	RT	1	2
Jump Jets	LT	4	2
Jump Jets	RT	4	2

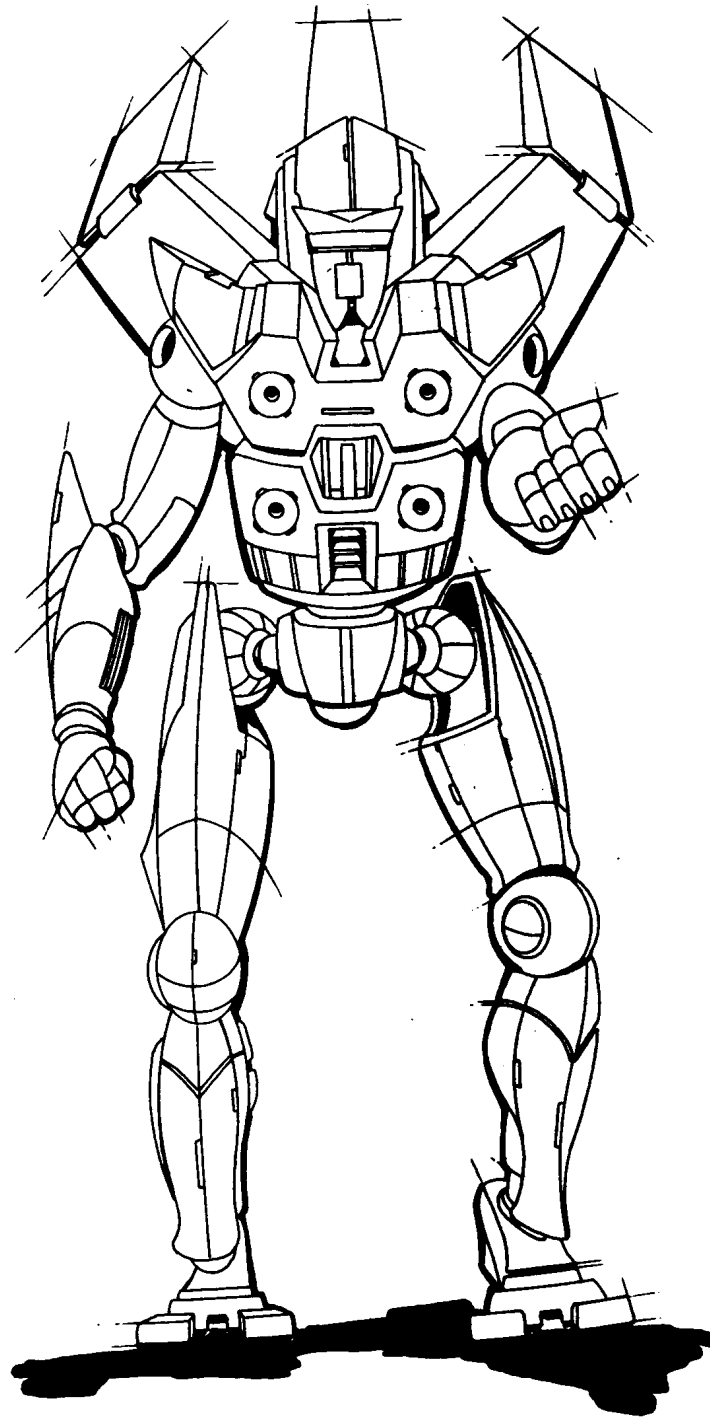



MEDIUM 'MECHS



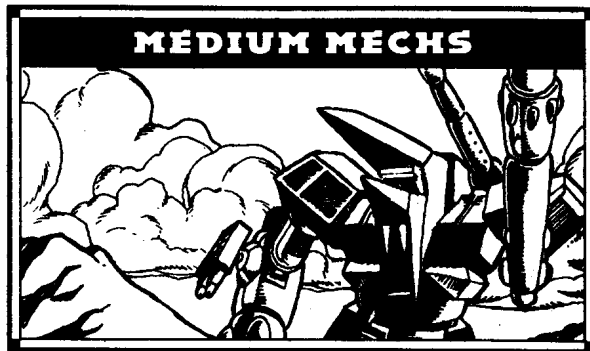

Mass: 40 tons

Chassis: Alshain Type 59-40M

Power Plant: Nissan 200

Cruising Speed: 54 kph

Maximum Speed: 81 kph

Jump Jets: None

Jump Capacity: None

Armor: Starshield with Ferro-Fibrous

Armament:

1 Lord's Light-2 Extended-Range PPC

2 Victory 23R Medium Lasers

1 Shannon SH-60 SRM-6 Rack

Manufacturer: Luthien Armor Works

Primary Factory: Luthien

Communications System: Sipher CommSys 4

Targeting and Tracking System: Eagle Eye SY10-10

Overview:

Luthien Armor Works was heavily damaged during the Clan invasion. A priority for the survival of the Draconis Combine was the repair of the facilities. While the buildings were under reconstruction, 'Mech designs were developed using new technologies and the experience gained from the horrific fighting that the Kurita forces had just endured. The *Daimyo* has the distinction of being the first new 'Mech design to be produced at the rebuilt Luthien Armor Works.

Capabilities:

The *Daimyo's* weaponry encompasses all firing ranges. The wide variety encourages different fighting styles among its pilots, though older MechWarriors who prefer more traditional tactics consider this a flaw.

The *Daimyo* has an extended-range particle projection cannon in its left arm and two medium lasers in the right. An SRM-6 rack is imbedded in the right torso, with one ton of ammunition.

Luthien Armor Works has installed double heat sinks instead of the standard ones, but MechWarriors who pilot the *Daimyo* must still be wary of heat buildup in the cockpit because firing all the 'Mech's weapons at once could be very dangerous.

The *Daimyo's* speed is equal to or better than any other 40-ton BattleMech in the Inner Sphere, but at the expense of the jump capability originally intended for the 'Mech. The Starshield ferro-fibrous armor allows the 'Mech to absorb tremendous amounts of firepower for its size.

Simulated testing results have been sent directly to the Gunji-no-Kanrei for his exclusive viewing. So far it seems that if the *Daimyo* has any major fault, it is in trying to do too many things at once for a medium 'Mech.

Deployment:

The *Daimyo* was first produced in February 3053. The new BattleMech was publicly displayed on Luthien to show the people the determination of the Dragon. After reviewing the initial test results, Theodore Kurita ordered that the first run of the new *Daimyos* be sent to units in areas near the Outworlds Alliance for further field testing. This design has yet to see actual combat, but is expected to do well.

Variants:

Several variants have been suggested for future *Daimyo* production. Possibilities include exchanging the ER PPC for a standard PPC or a large laser and extra heat sinks, exchanging the SRM-6 for another medium laser, or removing some armor and installing additional double heat sinks.

Type: **Daimyo**

Technology Base: Inner Sphere

Tonnage: 40

Equipment

		Mass
Internal Structure:		4
Engine:	200	8.5
Walking MP:	5	
Running MP:	8	
Jumping MP:	0	
Heat Sinks:	11 [22]	1
Gyro:		2
Cockpit:		3
Armor Factor:	134	7.5

	Internal Structure	Armor Value
Head	3	9
Center Torso	12	16
Center Torso (rear)		7
R/L Torso	10	15
R/L Torso (rear)		5
R/L Arm	6	12
R/L Leg	10	19

Weapons and Ammo	Location	Critical	Tonnage
ER PPC	LA	3	7
Medium Laser	RA	1	1
Medium Laser	RA	1	1
SRM 6	RT	2	3
Ammo (SRM) 30	RT	2	2



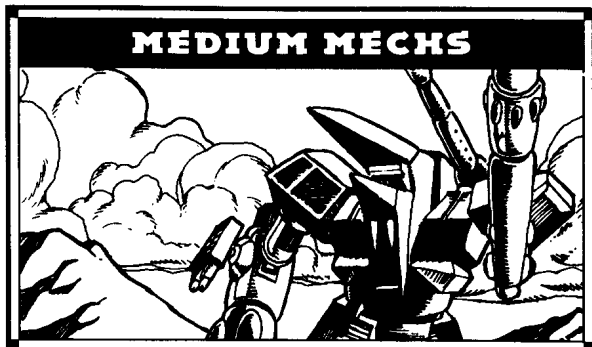

Mass: 40 tons

Chassis: Dorwinion Standard

Power Plant: Nissan 200

Cruising Speed: 54.7 kph

Maximum Speed: 87.1 kph

Jump Jets: HildCo Model 12

Jump Capacity: 150 meters

Armor: Starshield A

Armament:

1 ChisComp 43 Special Large Laser

2 ChisComp 39 Medium Lasers

2 SperryBrowning Machine Guns

Manufacturer: Robinson Standard BattleWorks

Primary Factory: Robinson

Communications System: Archernar Electronics

HICS-11

Targeting and Tracking System: Federated Hunter

Overview:

During the invasion, many Inner Sphere commanders concluded that the best way to fight the Clans was to assign front-line troops advanced equipment and to place them in front of the incoming juggernaut.

This method, used by both the Federated Commonwealth and the Draconis Combine, left many borders shortchanged in manpower and equipment. Local governments everywhere raised their concerns. One of the loudest in the F-C was Duke Aaron Sandoval, leader of the Draconis March. Unable and unwilling to return front-line units, Prince Davion quieted the Old Duke by sending him older equipment and

training units. Hanse Davion also invited Duke Sandoval to share the cost of retooling a factory to produce the *Watchman*, an inexpensive BattleMech suited for defense and training.

Capabilities:

Hanse Davion required that the design of the new 'Mech be based on a current model to reduce the capital investment. In no time, the old *Enforcer* was chosen as the basis for the design. As most of the factories that built *Enforcers* had already been upgraded to the new technology, huge stores of older parts were available.

The *Watchman* design dropped the autocannon because of weight considerations and the expense of ammunition for a training environment. This left the 'Mech a little under-gunned, and so the designers added a pair of ChisComp 39 medium lasers, found prominently on the early *Dervishes*. The two SperryBrowning machine guns were added as an afterthought, when anti-infantry weapons were appended to the specifications.

The cockpit controls were simplified, to facilitate instruction of inexperienced MechWarriors. The *Enforcer's* armor was replaced with Starshield A armor with CASE and the old McCloud Special jump jets were replaced by the more popular and less costly Hildco Model 12s, which permit the 'Mech to jump 150 meters. These changes lowered the weight of the completed design to 40 tons.

The *Watchman* showed its true colors when compared to light 'Mechs such as the *Wasp* and the *Stinger*, both plentiful in militia units. It carried more than twice the armor of a *Wasp*, and effectively paced the *Valkyrie* in field tests. Reliance on older, surplus beam weapons assures the *Watchman* a long life in garrison and training units.

Deployment:

The initial production of the new *Watchman* was delivered to the Second Robinson Rangers stationed on Phact. Although still quite rare, the 'Mech promises to become the backbone of the Federated Commonwealth's militia system, even if the Old Duke

would prefer to keep them all to himself.

Since the introduction of the *Watchman*, an increase in militia recruits was recorded for both the Crucis and Draconis Marches. Neither the Lyran Commonwealth State Command nor the Capellan March have shown any interest in the *Watchman*, content with the 'Mechs and the equipment they possess.

Type: Watchman

Technology Base: Inner Sphere

Tonnage: 40

Equipment

		Mass
Internal Structure:		4
Engine:	200	8.5
Walking MP:	5	
Running MP:	8	
Jumping MP:	5	
Heat Sinks:	12	2
Gyro:		2
Cockpit:		3
Armor Factor:	136	8.5
	<i>Internal Structure</i>	<i>Armor Value</i>
Head	3	8
Center Torso	12	16
Center Torso (rear)		8
R/L Torso	10	14
R/L Torso (rear)		6
R/L Arm	6	12
R/L Leg	10	20

Weapons and Ammo	Location	Critical	Tonnage
Large Laser	LA	2	5
Machine Gun	LA	1	.5
Machine Gun	LA	1	.5
Ammo (MG) 200	LT	1	1
CASE	LT	1	.5
Medium Laser	RA	1	1
Medium Laser	RA	1	1
Jump Jets	RL	2	1
Jump Jets	LL	2	1
Jump Jet	CT	1	.5



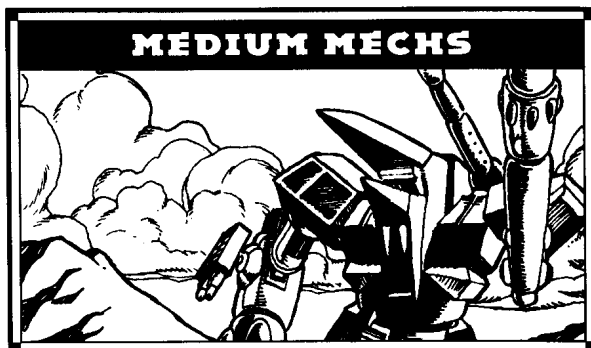

Mass: 45 tons

Chassis: Alshain Type Chi

Power Plant: VOX 225 XL

Cruising Speed: 54.7 kph

Maximum Speed: 87.1 kph

Jump Jets: Icarus 81

Jump Capacity: 150 meters

Armor: Valiant Lamellor

Armament:

10 Victory 23R Medium Lasers

2 Yori Flyswatter Anti-Missile Systems

Manufacturer: Luthien Armor Works

Primary Factory: New Samarkand

Communications System: Sipher Security Plus
with Guardian ECM Suite

Targeting and Tracking System: Eagle Eye
410 XX with TAG

Overview:

To many Inner Sphere troops, the battle-suited Elementals are the most worrisome of the Clan units. The Draconis Combine, after having captured several of these battle suits, began working on a 'Mech whose sole purpose is to hunt Elementals. Combine engineers named the design *Komodo* after the last Terran land dragon.

Capabilities:

While most 'Mechs are built with multiple roles in mind, the *Komodo* is a medium 'Mech designed for a specific purpose. The *Komodo* was conceived in late

3051, almost immediately after testing was completed on the captured Clan battle armor. The design is being produced at the Luthien Armor Works factory on Luthien. Because Luthien is so close to the front, House Kurita is debating the construction of a new factory deeper in Combine space.

The *Komodo* can travel at speeds up to 87.1 kph, thanks to the VOX 255 extra-light engine, and can jump up to 150 meters at a time. This makes the 'Mech ideal for anti-Elemental fighting. The 7.5 tons of Valiant Lamellor armor ensure survival in a stand-up fight against Stars of Elementals.

The ten Victory 23R medium lasers may seem excessive armament for a medium 'Mech, yet to accomplish the *Komodo's* task of destroying an entire Point of Elementals in one volley, anything less would be useless. To counter the massive heat build-up of these weapons, 14 double-strength heat sinks were included. A pair of Yori Flyswatter anti-missile systems guard the MechWarrior against the single SRM volley that Elemental Points can launch.

The major flaw of this 'Mech is the lack of long-range weapons. On a battlefield devoid of Elementals, the *Komodo* becomes little more than a target.

Deployment:

A large number of *Komodos* are being moved from the Luthien Armor Works to Wolcott. It is believed that these "Elemental-killers" will be used in a raid or raids into surrounding Clan-controlled systems. At present the planet Albiero, currently under the tight grip of Clan Smoke Jaguar, is considered the optimum target for such an attack.

Variants:

The only known variant of the *Komodo* is the KIM-2A, which attempts to give the design some long-range firepower by replacing the left-arm medium laser cluster with a Victory Nickel Alloy ER large laser. About one in every five *Komodos* is a KIM-2A variant. The KIM-2A is usually assigned to provide long-range cover fire for the standard *Komodos*.

Type: **Komodo**

Technology Base: Inner Sphere

Tonnage: 45

Equipment

		Mass
Internal Structure:		4.5
Engine:	225 XL	5
Walking MP:	5	
Running MP:	8	
Jumping MP:	5	
Heat Sinks:	14 [28]	4
Gyro:		3
Cockpit:		3
Armor Factor:	120	7.5

	Internal Structure	Armor Value
Head	3	9
Center Torso	14	13
Center Torso (rear)		6
R/L Torso	11	12
R/L Torso (rear)		4
R/L Arm	7	14
R/L Leg	11	16

Weapons and Ammo	Location	Critical	Tonnage
TAG	H	1	1
Anti-Missile System	RA	1	.5
Ammo (Anti-Missile) 12	RA	1	1
Medium Laser	RA	1	1
Medium Laser	RA	1	1
Medium Laser	RA	1	1
Medium Laser	RA	1	1
Medium Laser	RA	1	1
Medium Laser	RA	1	1
Anti-Missile System	LA	1	.5
Ammo (Anti-Missile) 12	LA	1	1
Medium Laser	LA	1	1
Medium Laser	LA	1	1
Medium Laser	LA	1	1
Medium Laser	LA	1	1
Medium Laser	LA	1	1
Guardian ECM Suite	RT	2	1.5
Jump Jets	RL	2	1
Jump Jets	LL	2	1
Jump Jet	CT	1	.5



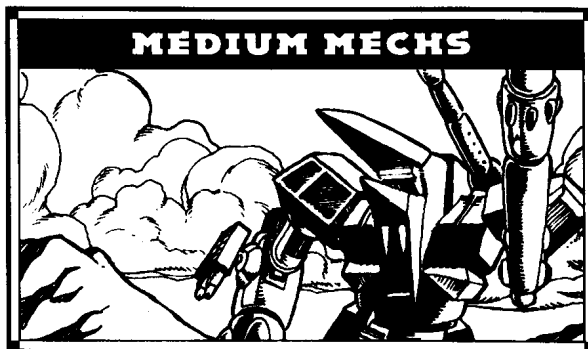

Mass: 45 tons

Chassis: Ceresplex IV

Power Plant: VOX 225 XL

Cruising Speed: 54 kph

Maximum Speed: 86.4 kph

Jump Jets: Anderson Propulsion 30

Jump Capacity: 150 meters

Armor: Starshield with CASE

Armament:

1 Mydron Excel LB-10X Autocannon

3 Hovertec Streak SRM-2 Rack

Manufacturer: Ceres Metals Industries

Primary Factory: Capella

Communications System: CeresCom Model 21-Rs

Targeting and Tracking System: Dwyerson Mark XII

Overview:

Although most of the Great Houses of the Inner Sphere have projects underway to develop battle armor of their own, the training and tactics involved in properly utilizing such forces must be developed from the ground up. Many 'Mech-producing firms have opted instead to meet the challenge of the Clan Elemental by producing BattleMechs specifically designed to counter their advantages. One such 'Mech is Ceres Metals' SNK-1V *Snake*, built around the *Vindicator* Ceresplex IV chassis.

Capabilities:

Ceres Metals technicians debated for months about which blend of weapons and mobility would best counter the fearsome Elementals. Some favored

mounting large numbers of medium lasers, an approach used in the Kurita KIM-2 *Komodo*. Others believed that long-range missiles would be effective in neutralizing battle armor before it got close enough to retaliate. The design of the *Snake* solved the problem with two very different weapons systems, both of which addressed this problem directly.

The *Snake's* primary weapon is the Mydron Excel LB-10X autocannon, which is ideal for a number of reasons. First, it could be easily mounted on the right arm, where the *Vindicator* carries a PPC. Second, its range was good enough to allow several salvos before the Elementals could close to short range. Third, and perhaps most important, the LB-10X autocannon can be loaded with special cluster munitions that fire a wide, shotgun-like spread of submunitions rather than a single stream of projectiles. This characteristic helps to negate the Elementals' advantage of dispersion, by spreading the attack across the entire Point.

The secondary weapon system is the proven Hovertec Streak SRM-2 rack. The *Snake* mounts three of these launchers in its left torso, matching the location of the *Vindicator's* LRM-5 rack.

The *Snake's* running speed was carefully calculated. The designers wanted to give the 'Mech enough mobility to easily outrun battle armor, but wanted to avoid excessive engine size to leave room for weapons systems. A top speed of 86 kph was chosen, and jump jets were installed as a design necessity, considering the intended target.

The final product performs its intended mission well, at least in simulation. Weight limitations forced designers to remove the *Snake's* only backup weapon, a medium laser mounted in the head. The reliance on ammunition this creates may seem a serious limitation, but is expected to actually improve the *Snake's* overall survivability. Pilots will be forced to retreat to friendly lines when their ammo is expended, rather than staying and fighting with only a single small weapon.

Deployment:

The *Snake* is currently being produced on Capella at a modest rate, and the bulk of those already produced are also stationed there. A lance of *Snakes* has

been transferred to the Free Worlds League, who placed them with the Thirtieth Marik Militia on Wing. Negotiations are underway for sale of the design to the DCMS, putting the *Snake* in direct competition with the *Komodo*. If an agreement is reached, production can easily be tripled or quadrupled due to the fact that, like the *Vindicator*, nearly all of the *Snake's* components are also produced on Capella.

Type: *Snake*

Technology Base: Inner Sphere

Tonnage: 45

Equipment		Mass
Internal Structure:		4.5
Engine:	225 XL	5
Walking MP:	5	
Running MP:	8	
Jumping MP:	5	
Heat Sinks:	11 [22]	1
Gyro:		3
Cockpit:		3
Armor Factor:	112	7
	Internal Structure	Armor Value
Head	3	8
Center Torso	14	16
Center Torso (rear)		6
R/L Torso	11	11
R/L Torso (rear)		4
R/L Arm	7	10
R/L Leg	11	16

Weapons and Ammo	Location	Critical	Tonnage
LB 10-X AC	RA	6	11
Ammo (LB-X) 20	RT	2	2
Streak SRM 2	LT	1	1.5
Streak SRM 2	LT	1	1.5
Streak SRM 2	LT	1	1.5
Ammo (Streak) 50	RT	1	1
CASE	RT	1	.5
Jump Jet	CT	1	.5
Jump Jets	RL	2	1
Jump Jets	LL	2	1



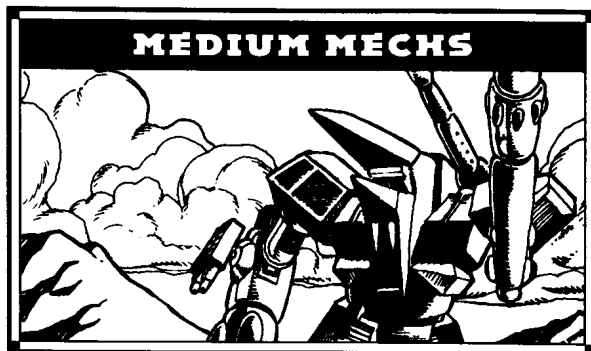

Mass: 45 tons

Chassis: GM Stealth Endo Steel

Power Plant: GM 315 XL

Cruising Speed: 76 kph

Maximum Speed: 119 kph, 151 kph w/MASC

Jump Jets: 100AFVTA

Jump Capacity: 210 meters

Armor: Durallex Medium

Armament:

1 Shannon SH-60 SRM-6 Rack

1 Federated SuperStreak SRM-2 Rack

2 Diplan M3 Medium Lasers

Manufacturer: General Motors

Primary Factory: Kathil

Communications System: Dalban Micronics

Targeting and Tracking System: Dalban HiRez

Overview:

When Federated Commonwealth officials requested plans for a new scout 'Mech that could sustain more damage than existing designs, General Motors of Kathil responded with the *Stealth*.

The *Stealth* is a 45-ton 'Mech that is the latest entry into the long list of BattleMechs produced by GM over the years for the Lyran Commonwealth and the Federated Suns. The *Stealth* is likely to be the heaviest 'Mech that will be used by the F-C forces in a scouting role.

With its advanced scouting capabilities and enhanced survivability, the *Stealth* may well play a pivotal role in the reconquest of Federated Commonwealth planets from the Clan invaders.

Capabilities:

The *Stealth* is a dynamic 'Mech for the medium-size designation. It cruises at 76 kph and can attain 119 kph before engaging MASC. When MASC is engaged, the 45-ton 'Mech can move at 152 kph.

The *Stealth* has an SRM-6 in its left torso and a Streak SRM-2 in its right torso. Both missile racks are supplied with one ton of ammunition each. There are also two standard medium lasers for fire support as well as a Beagle active probe. The planners at GM were excited about being able to produce a 'Mech that had both MASC and a Beagle probe and simulator tests have been very promising.

The *Stealth* utilizes endo steel in its framework and is also jump-capable. It can travel up to 210 meters per jump. The *Stealth* is also equipped with double heat sinks and substantial armor. The design also utilizes a GM 315 XL that is produced at the same facilities on Kathil.

The *Stealth* has undergone extensive testing, from standard endurance tests to stress tests on various features. The most unusual test conducted was the height test. A *Stealth* chassis covered in the appropriate amount of armor was deliberately dropped from a height of 100 meters. The engineers were hoping to determine if the structural integrity of the 'Mech was sound, based upon the height dropped, weight, and the 'Mech's jump capability. The design team claims that the test was a success.

Some of the design's critics complain that the 'Mech lacks firepower, while others consider using so heavy a BattleMech exclusively for reconnaissance missions an irresponsible mistake. Only time will tell, but the Federated Commonwealth is banking on the *Stealth*.

Deployment:

The *Stealth* has only recently come out of production on Kathil. Those placed into direct service have been scattered throughout the Federated Commonwealth military to replace destroyed scouting units. Initially, these 'Mechs have been assigned to scout lance commanders.

Rumors abound in military circles that the Federated Commonwealth military is forming an elite commando team of some kind. This may be pure fantasy, but the rumors center around the use of the *Stealth* as a key unit. So far, production records for the GM facility on Kathil do not support these speculations.

Type: **Stealth**

Technology Base: Inner Sphere

Tonnage: 45

Equipment		Mass
Internal Structure:	Endo Steel	2.5
Engine:	315 XL	11
Walking MP:	7	
Running MP:	11(14)	
Jumping MP:	7	
Heat Sinks:	10 [20]	0
Gyro:		4
Cockpit:		3
Armor Factor:	144	9
	<i>Internal Structure</i>	<i>Armor Value</i>
Head	3	9
Center Torso	14	21
Center Torso (rear)		6
R/L Torso	11	17
R/L Torso (rear)		5
R/L Arm	7	12
R/L Leg	11	20

Weapons and Ammo	Location	Critical	Tonnage
SRM 6	LT	2	3
Ammo (SRM) 15	LT	1	1
Streak SRM 2	RT	1	1.5
Ammo (Streak) 50	RT	1	1
Medium Laser	LT	1	1
Medium Laser	RT	1	1
MASC	LT	2	2
Beagle Active Probe	RT	2	1.5
Jump Jets	LT	3	1.5
Jump Jets	RT	3	1.5
Jump Jet	CT	1	.5



HUR-WO-R4L HURON WARRIOR

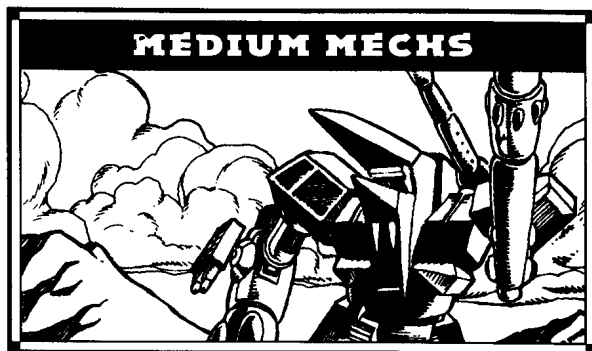

Mass: 50 tons
Chassis: Geometric 590 Endo Class HC (Hard Core)
Power Plant: Magna 250 XL
Cruising Speed: 54 kph
Maximum Speed: 86.4 kph
Jump Jets: None
Jump Capacity: None
Armor: Valiant Lamellor
Armament:
 Grizzard Gauss Rifle (Modified 210 Version)
 Martell Extended Range Large Laser
 Martell Medium Pulse Laser
Manufacturer: Hollis Incorporated
Primary Factory: Corey
Communications System: O/P COM-500
Targeting and Tracking System: O/P Scanoptics Model 5

Overview:

Like the Free Worlds League, the Capellan Confederation profited economically from the Clan invasion. Making use of the new technologies, the Hollis Industries, located on several key Capellan worlds, began to upgrade their existing designs. The *Huron Warrior* is the result of one such modification.

The original 3051 specifications for the *Huron Warrior* BattleMech called for a somewhat slower 'Mech to be outfitted with two LRM-15 racks and four medium lasers. With the access to the recovered Star League and captured Clan technologies, Hollis engineers drastically altered their original design. By incor-

porating the new weaponry, a stronger and lighter Geometric 590 HC endo steel chassis, and the more efficient Magna XL engine, the *Huron Warrior* took on a new, more menacing aspect.

The design team named the BattleMech for its stately form and for the fact that the sensor array on top of the cockpit resembles an ancient Earth Indian war bonnet. The lead engineer, Danial Peterson Longfeather, is a descendant of the Huron tribe of North America. He contributed modifications to the exterior of the 'Mech that added to its Indian warrior appearance.

Capabilities:

The *Huron Warrior* was designed to counter the *Black Hawk* OmniMech of the invading Clans. Though it is difficult to match all the technological prowess of these formidable foes, the *Huron Warrior* carries heavier armor and a deadly punch spearheaded by a Grizzard Gauss rifle.

The Grizzard on the *Huron Warrior* is a highly modified 210 version. It is much longer, but its slender design lets it fit within the tight confines of the *Huron Warrior's* right arm. The newly designed Martell pulse and extended-range lasers supplement the Gauss rifle.

The first trial runs of the *Huron Warrior* impressed both Hollis investors and the MechWarriors piloting the prototypes. The machine carried enough armor to remain in a fight for extended periods, and the long-range capabilities of the new weaponry seemed a strong match for existing BattleMechs of the same weight class.

Deployment:

McCarron's Armored Cavalry is currently the only unit equipped with any number of these new 'Mechs, but they have reported nothing but success in their operations. House Marik's Second Sirian Lancers have also ordered several *Huron Warriors* to replace some of their older 'Mechs. It is rumored, but not confirmed, that several *Huron Warriors* have also been sold to Word of Blake forces within the Free Worlds League.

Variants:

The only known modification to the *Huron Warrior* is HUR-WO-R4M, which is being tested in the Free Worlds League by House Marik. This version removes the medium pulse laser and adds an additional two tons of Valiant Lamellor armor to the 'Mech. The bulk of this additional armor is concentrated on the legs and torso of the *Warrior*, greatly increasing the rear armor as well. This modification is an attempt to provide better protection against Clan Elemental attacks, even though House Marik forces have yet to face this particular menace.

Type: Huron Warrior
Technology Base: Inner Sphere
Tonnage: 50

Equipment		Mass
Internal Structure:	Endo Steel	2.5
Engine:	250 XL	6.5
Walking MP:	5	
Running MP:	8	
Jumping MP:	0	
Heat Sinks:	11	1
Gyro:		3
Cockpit:		3
Armor Factor:	160	10
	<i>Internal Structure</i>	<i>Armor Factor</i>
Head	3	9
Center Torso	16	22
Center Torso (rear)		9
R/L Torso	12	17
R/L Torso (rear)		7
R/L Arm	8	16
R/L Leg	12	20

Weapons and Ammo	Location	Critical	Tonnage
Gauss Rifle	RA	7	15
Ammo (Gauss) 16	RT	2	2
ER Large Laser	LA	2	5
Medium Pulse Laser	LT	2	2

HUR-WO-R4L HURON WARRIOR

MEDIUM 'MECHS

43



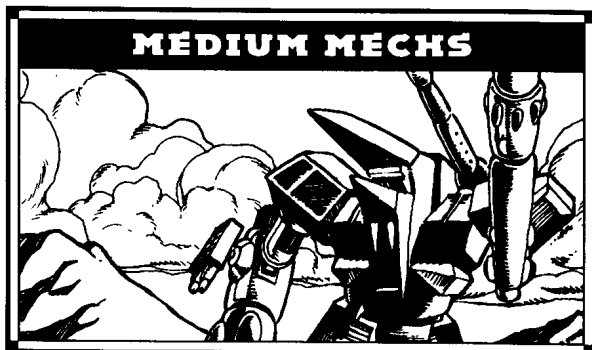

Mass: 50 tons

Chassis: Dorwinion Standard

Power Plant: Vlar 300 XL

Cruising Speed: 64.8 kph

Maximum Speed: 97.2 kph

Jump Jets: HildCo Model 13

Jump Capacity: 180 meters

Armor: Kallon Royalstar

Armament:

- 1 Sutel Precision Line Large Pulse Laser
- 2 Sutel Precision Line Medium Pulse Lasers
- 1 Sutel Precision Line Small Pulse Laser

Manufacturer: Defiance Industries

Primary Factory: Hesperus II

Communications System: TharHes Calliope Hm10

Targeting and Tracking System: TharHes Ares-8a

Overview:

Among the few advantages Federated Commonwealth forces enjoyed against the Clans was one of the most basic—the hatchet. A hatchet was first installed in the Federated Suns *Hatchetman* 'Mech, and the design element was included in the more recent *Axman*. In light of the success of the *Hatchetman* and the *Axman* against Clan forces, the F-C military commissioned the *Nightsky*, a new hatchet-bearing 'Mech of a size midway between the *Hatchetman* and the *Axman*.

Capabilities:

The *Nightsky* is produced on Hesperus II and is similar in design to both the other hatchet-bearing 'Mechs. As the *Nightsky* is only five tons heavier than the *Hatchetman*, that some enemy pilots may not be able to distinguish the difference at first glance, which could offer a distinct combat advantage.

In addition to the right-arm hatchet, the *Nightsky* carries a large pulse laser in its left arm. The right and left torsos each mount a medium pulse laser, while the head is equipped with a small pulse laser. Each of these weapons weighs enough that they have been distributed to different parts of the 'Mech.

Six jump jets allow the 'Mech to leap up to 180 meters. The *Nightsky* has double heat sinks, and a Vlar 300 XL engine that allows it to run at speeds approaching 100 kph. The communications and the targeting and tracking systems are both from TharHes Industries and are readily available on Hesperus II.

Deployment:

Defiance Industries released the first *Nightsky* into Federated Commonwealth hands in March 3053. Since that time, two full runs have been produced and are stationed or on their way to positions throughout the Federated Commonwealth. The *Nightsky* will be replacing 'Mechs that were destroyed during the Clan invasion, with first priority going to former *Hatchetman* and *Axman* pilots. Response to the new design has been satisfactory.

Variants:

All the variants in the works so far leave the hatchet in its present position, although shifting the hatchet to the left hand is an option for left-handed pilots.

It has been suggested that the heavy pulse weapons be removed to make room for lighter weapons or a missile defense system. Removing the jump jets has also been suggested to allow for additional heat sinks. As the *Nightsky* has no long-range weaponry, replacing the large pulse laser and some armor with an extended-range PPC has been advanced as another plausible upgrade.

Type: *Nightsky*

Technology Base: Inner Sphere

Tonnage: 50

Equipment

		Mass
Internal Structure:		5
Engine:	300 XL	9.5
Walking MP:	6	
Running MP:	9	
Jumping MP:	6	
Heat Sinks:	11 [22]	1
Gyro:		3
Cockpit:		3
Armor Factor:	152	9.5

	Internal Structure	Armor Value
Head	3	9
Center Torso	16	23
Center Torso (rear)		6
R/L Torso	12	18
R/L Torso (rear)		5
R/L Arm	8	14
R/L Leg	12	20

Weapons and Ammo	Location	Critical	Tonnage
Hatchet	RA	4	4
Large Pulse Laser	LA	2	7
Medium Pulse Laser	LT	1	2
Medium Pulse Laser	RT	1	2
Small Pulse Laser	H	1	1
Jump Jets	CT	2	1
Jump Jets	LL	2	1
Jump Jets	RL	2	1



APL-1M APOLLO

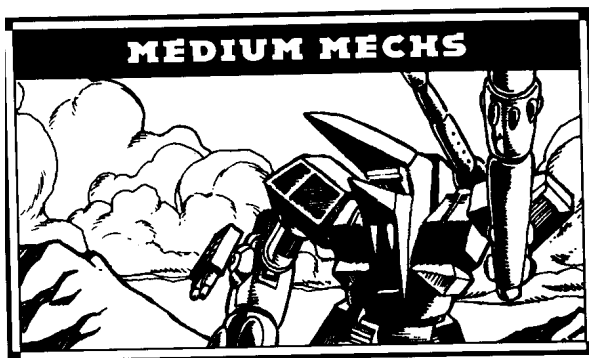

Mass: 55 tons

Chassis: Earthwerks APL I

Power Plant: DAV 220

Cruising Speed: 43 kph

Maximum Speed: 65 kph

Jump Jets: None

Jump Capacity: None

Armor: Maximilian 44

Armament:

2 Zeus LRM-15 Racks with Artemis IV FCS

2 Sunglow Prism-Optic Small Pulse Lasers

Manufacturer: Earthwerks Incorporated

Primary Factory: Keystone

Communications System: Neil 6000

Targeting and Tracking System: Garrett A6

Overview:

Earthwerks Incorporated, of Keystone, began producing the *Apollo* when the Free Worlds League military requested a new design for a medium fire-support 'Mech. Earthwerks anticipates a large and steady production of these 'Mechs for a long time and plans to expand its facilities on Keystone for just this one design.

The Draconis Combine has expressed interest in the 'Mech and is expected to place an order very soon. It is rumored that the Federated Commonwealth also plans to develop a similar 'Mech when the resources become available. Other Earthwerks facilities may produce the *Apollo* later, should orders merit such a move.

Capabilities:

The *Apollo* was nicknamed the "mini-*Archer*" by its designers, who used the tried and true *Archer* as a model for a 'Mech that could offer effective fire support. The new design uses two LRM-15 racks with Artemis fire-control systems and two small pulse lasers for close-in support.

The *Apollo* is lighter than the *Archer* by fifteen tons, so its missile launchers are smaller and it has less armor. Critics have compared the new 'Mech to the *Trebuchet*, claiming that the *Apollo* is a less costly Earthwerks knockoff, but these allegations have been flatly denied.

Deployment:

With large production runs ordered, Earthwerks is producing an unprecedented number of *Apollos*. Exportation of this design to the Draconis Combine is expected in the near future, but Earthwerks has been instructed to refuse any Federated Commonwealth, St. Ives Compact, or Rasalhague orders for the new 'Mech.

Apollos have appeared in several units along the F-C border, along the former Lyran border, and in the acquired Capellan territories. The prime purpose is the replacement of decrepit front-line 'Mechs being used in support positions. The Marik Guards units near Terra are the first to receive the *Apollo*.

Apollos have been placed successfully in fire lances with the old *Rifleman* design as a companion. Field tests have shown a remarkable compatibility between 'Mechs whose primary weapon is the autocannon. *Vulcans*, *Crabs*, and the occasional *JagerMech* have also been spotted in lances with *Apollos*.

Variants:

Because the *Apollo* is so new, Earthwerks Incorporated is loathe to tamper with the design, and has shelved a number of proposed changes. One of these changes reportedly involves removal of the Artemis systems in favor of additional ammunition. Another rumored change is the removal of armor and the small pulse lasers for standard medium lasers and

additional heat sinks. A third change is believed to recommend downgrading the missile launchers for additional ammunition and medium-range weaponry. None of these variants are currently in production, nor are they likely to be for some time.

Type: *Apollo*

Technology Base: Inner Sphere

Tonnage: 55

Equipment

		Mass
Internal Structure:		5.5
Engine:	220	10
Walking MP:	4	
Running MP:	6	
Jumping MP:	0	
Heat Sinks:	10 [20]	0
Gyro:		3
Cockpit:		3
Armor Factor:	184	11.5

	Internal Structure	Armor Value
Head	3	9
Center Torso	18	28
Center Torso (rear)		7
R/L Torso	13	20
R/L Torso (rear)		6
R/L Arm	9	18
R/L Leg	13	26

Weapons and Ammo	Location	Critical	Tonnage
LRM 15	LT	3	7
Ammo (LRM) 16	LT	2	2
Artemis IV FCS	LT	1	1
LRM 15	RT	3	7
Ammo (LRM) 16	RT	2	2
Artemis IV FCS	RT	1	1
Small Pulse Laser	CT	1	1
Small Pulse Laser	CT	1	1



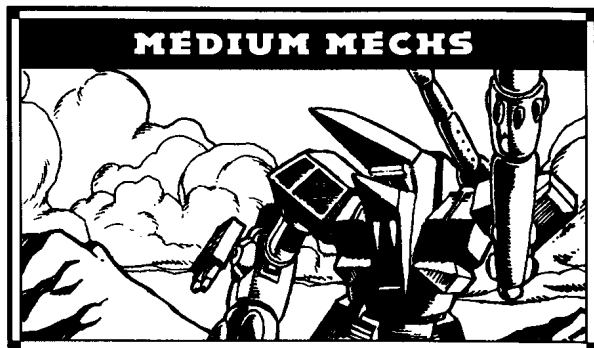

Mass: 55 tons
Chassis: Gigi 200
Power Plant: Core Tek 275 XL
Cruising Speed: 54 kph
Maximum Speed: 86.4 kph
Jump Jets: None
Jump Capacity: None
Armor: StarGuard 3056 Ferro-Fibrous
Armament:
 Holly LRM-20 Rack
 Holly SRM-6 Rack
 Blankenburg Extended Range Large Laser
 McArthur II Anti-Missile System
 Blankenburg Medium Pulse Laser
Manufacturer: Blankenburg Technologies
Primary Factory: Terra
Communications System: Marshall 333
Targeting and Tracking System:
 O/P Scanoptics 400BP

Overview:

ComStar's military force never had to undertake full-scale BattleMech production, as it never incurred any significant losses. Any necessary replacements were easily filled from ComStar's vast inventory of Star League-era 'Mechs. Then came the Clan invasion and the horrors of Tukayyid.

ComStar found itself facing massive losses among the Com Guards, not only from battlefield casualties, but from defections to the Word of Blake forces in the Free World's League as well. As a result of these com-

bined drains on its resources, ComStar began a massive program of rebuilding factories to create a new generation of BattleMechs to replenish its losses.

The Blankenburg Technologies facility on Terra was the first factory to be ready for full production. Rather than build age-old Star League designs, the facility would produce a new age of ComStar BattleMechs, led by the *Grim Reaper*.

Capabilities:

At the heart of the *Grim Reaper's* long-range capabilities are a Holly LRM-20 rack, coupled with a Blankenburg Technologies extended-range large laser. The goal of this design combination was to give the *Reaper* the ability to wear down opponents at long ranges, while still providing long-range fire-support capabilities if needed.

At short ranges the *Reaper* is even more menacing. It carries the proven Holly SRM-6 missile array mounted on its left arm, with the missile launch tubes surrounding its medium pulse laser. The missile ammunition is stored in the left torso, but both the torso and arm are equipped with CASE to prevent any stored or already loaded/armed missiles that explode from doing more than minimal damage to the internal structure.

For defense the *Grim Reaper* is protected with a strong shell of StarGuard 3056 ferro-fibrous armor, manufactured in the Homer plant just outside the Blankenburg factory. A McArthur II anti-missile system, an updated remanufacture of the Star League's standard AMS, sits in the 'Mech's neck region.

Deployment:

Grim Reapers went into production only five months after the battle of Tukayyid, with shipment of the new 'Mechs beginning almost immediately. In a surprising move, ComStar has sold a number of *Grim Reapers* to the Draconis Combine. Most of these have been assigned to the First and Second Sword of Light regiments, replacing their losses. They can be found in the greatest numbers in the Free Rasalhague Republic, where the Com Guards have begun a massive entrenchment effort, preparing for the inevitable Clan offensive toward Terra.

Type: Grim Reaper
Technology Base: Inner Sphere
Tonnage: 55

Equipment		Mass
Internal Structure:		5.5
Engine:	275 XL	8
Walking MP:	5	
Running MP:	8	
Jumping MP:	0	
Heat Sinks:	10 [20]	0
Gyro:		3
Cockpit:		3
Armor Factor:	188	10.5
	<i>Internal Structure</i>	<i>Armor Factor</i>
Head	3	9
Center Torso	18	26
Center Torso (rear)		10
R/L Torso	13	18
R/L Torso (rear)		8
R/L Arm	9	18
R/L Leg	13	26

Weapons and Ammo	Location	Critical	Tonnage
LRM 20	RT	5	10
Ammo (LRM) 12	RT	2	2
SRM 6	LA	2	3
Ammo (SRM) 15	LT	1	1
ER Large Laser	RA	2	5
Anti-Missile System	CT	1	.5
Ammo (Anti-Missile) 12	RT	1	1
Medium Pulse Laser	LA	1	2
CASE	LT	1	.5

GRM-R-PR29 GRIM REAPER

MEDIUM 'MECHS

49

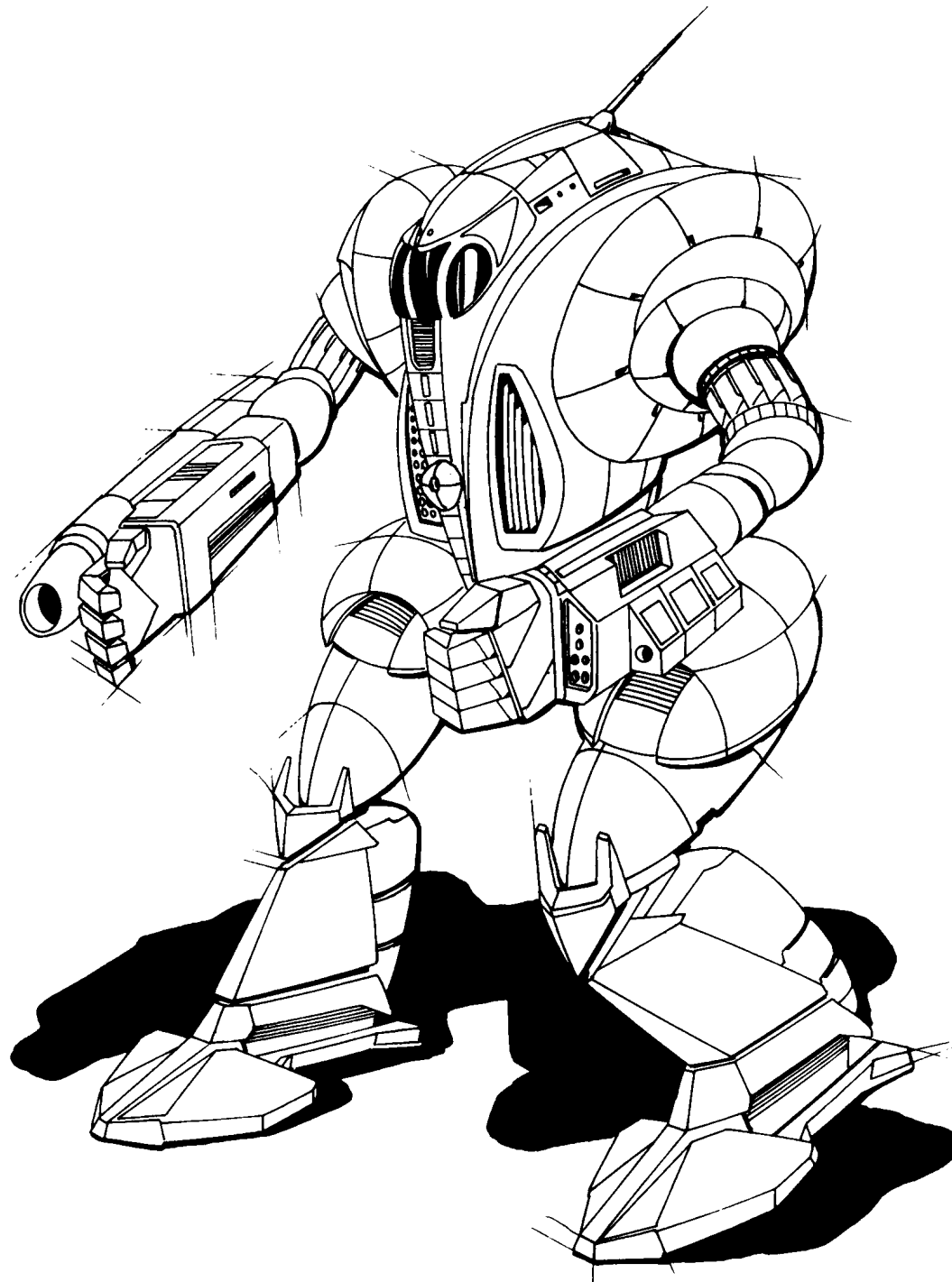

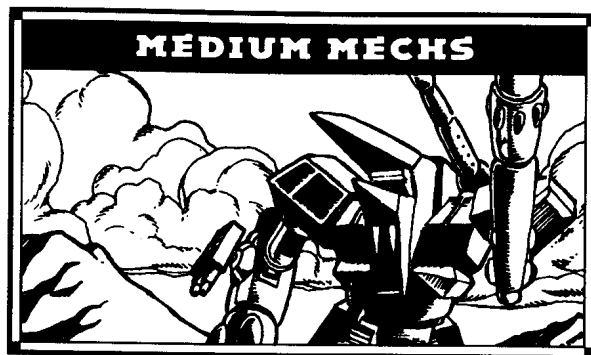

Mass: 55 tons
Chassis: Curtiss Wraith
Power Plant: LTV 385 EL
Cruising Speed: 75.6 kph
Maximum Speed: 118.8 kph
Jump Jets: CurtissJet 55
Jump Capacity: 210 meters
Armor: Kallon FWL Special Ferro-Fibrous
Armament:
 1 Tronel XIII Large Pulse Laser
 2 Tronel XII Medium Pulse Lasers
Manufacturer: Curtiss Militech
Primary Factory: Paradise
Communications System: CurtissComm Mark I
Targeting and Tracking System: Dynatec 2780

Overview:

Curtiss Hydrosystems has long been a major company within the Free Worlds League, producing most of the water purification systems used in that realm. While recently discovered lostech has greatly benefited the producers of armaments, the public sector remains largely unaffected. The costs of manufacturing and maintaining advanced water purification equipment continues to rise, with no end in sight.

In light of the current need for innovative and advanced military hardware, and Curtiss' need for more profits, the company created Curtiss Militech, a new subdivision devoted entirely to BattleMech production and design. Their idea people quickly went to work to produce a revolutionary new 'Mech that would

make military heads turn, using all-new materials and components. The result was a truly state-of-the-art 'Mech: the TR1 *Wraith*.

Capabilities:

The *Wraith* is designed for maximum speed and maneuverability; all other concerns were secondary. To achieve this end, a massive LTV 385 Extra-light engine was installed, giving the 'Mech a maximum running speed of more than 115 kph. Combined with a jump capacity of 210 meters, the *Wraith* has unprecedented mobility for a 55-ton 'Mech.

The compact CurtissJets, designed and produced at the same facility as the 'Mech, are very efficient and lightweight because of their proximity to the engine.

The *Wraith's* armaments are also advanced. It carries a Tronel XIII large pulse laser in its right hand, and also mounts two Tronel XII medium pulse lasers. These weapons provide extremely accurate laser fire, sacrificing range for damage. The range limitation is not a problem because the *Wraith* clearly has enough speed to close with the enemy.

The chassis has an endo steel internal structure, which is protected by nine tons of ferro-fibrous armor. To offset the tremendous heat generated by jumping and firing pulse lasers, the *Wraith* is equipped with ten double heat sinks. To avoid a serious heat spike, *Wraith* pilots are cautioned to avoid jumping full distance and firing all weapons at the same time.

All these factors combine to create a highly advanced 'Mech, well-suited to deep recon missions. Its designers hope that its large size will allow it to compete favorably with Clan recon 'Mechs, which tend to sacrifice armor for speed and firepower. The *Wraith* is far more resilient than lighter recon units, and can deliver accurate laser fire.

As with the CGR-1A1 *Charger*, the *Wraith's* detractors claim that the 'Mech's unique design will make battlefield repair nearly impossible. Curtiss counters such arguments with a liberal warranty, and already produces large amounts of replacement parts that automatically ship with each unit. Few can argue with the obvious technical sophistication of the *Wraith*. It is a promising new entry into the Free Worlds arsenal.

Deployment:

A company of *Wraiths* is stationed on Paradise, although it is unknown whether they are there to guard the Curtiss factories, or are simply awaiting purchase. The balance of the first run has been shipped to various Free Worlds units along the Marik-Steiner border. Production continues despite the stockpile, suggesting that Curtiss is also expecting to sell to House Kurita in the near future.

Type: Wraith

Technology Base: Inner Sphere

Tonnage: 55

Equipment		Mass
Internal Structure:	Endo Steel	3
Engine:	385 XL	22
Walking MP:	7	
Running MP:	11	
Jumping MP:	7	
Heat Sinks:	10 [20]	0
Gyro:		4
Cockpit:		3
Armor Factor:	152	8.5
	<i>Internal Structure</i>	<i>Armor Value</i>
Head	3	8
Center Torso	18	23
Center Torso (rear)		7
R/L Torso	13	18
R/L Torso (rear)		5
R/L Arm	9	14
R/L Leg	13	20

Weapons and Ammo	Location	Critical	Tonnage
Large Pulse Laser	RA	2	7
Medium Pulse Laser	LA	1	2
Medium Pulse Laser	LA	1	2
Jump Jets	RT	3	1.5
Jump Jet	CT	1	.5
Jump Jets	LT	3	1.5

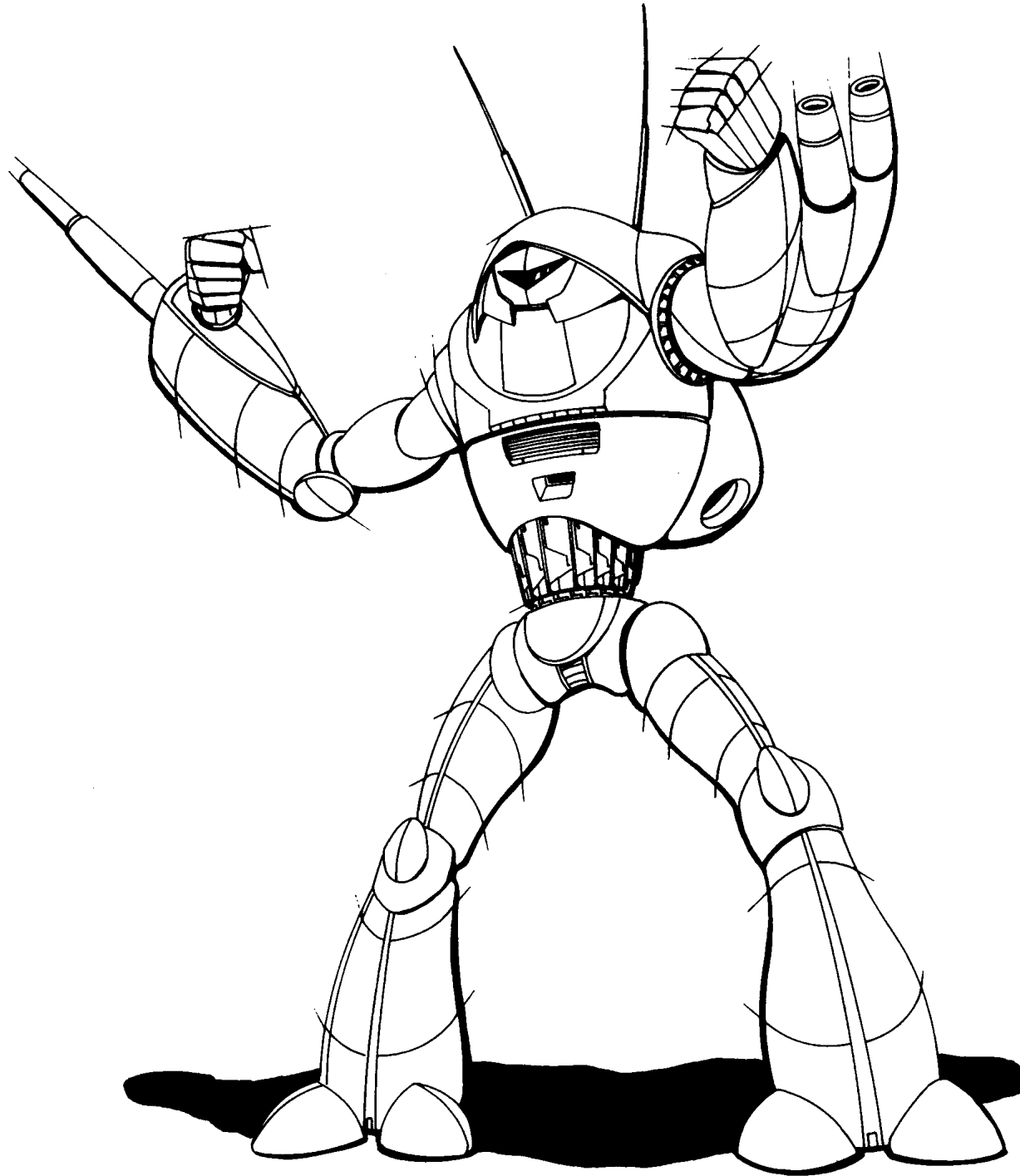

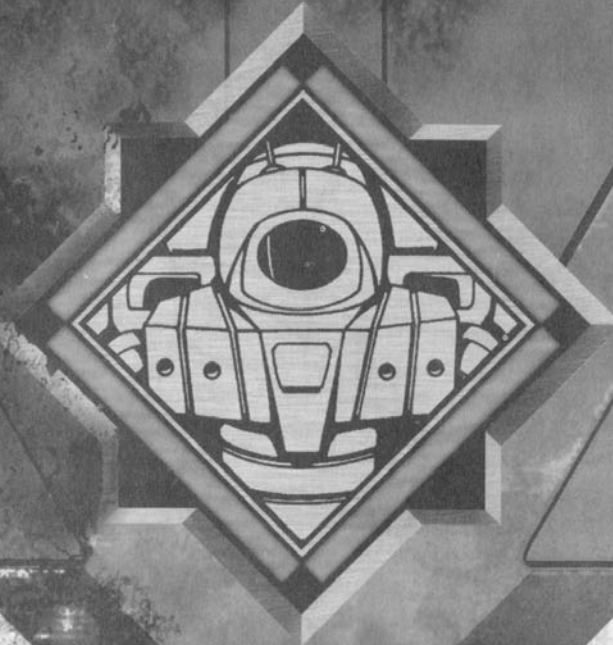

HEAVY 'MECHS

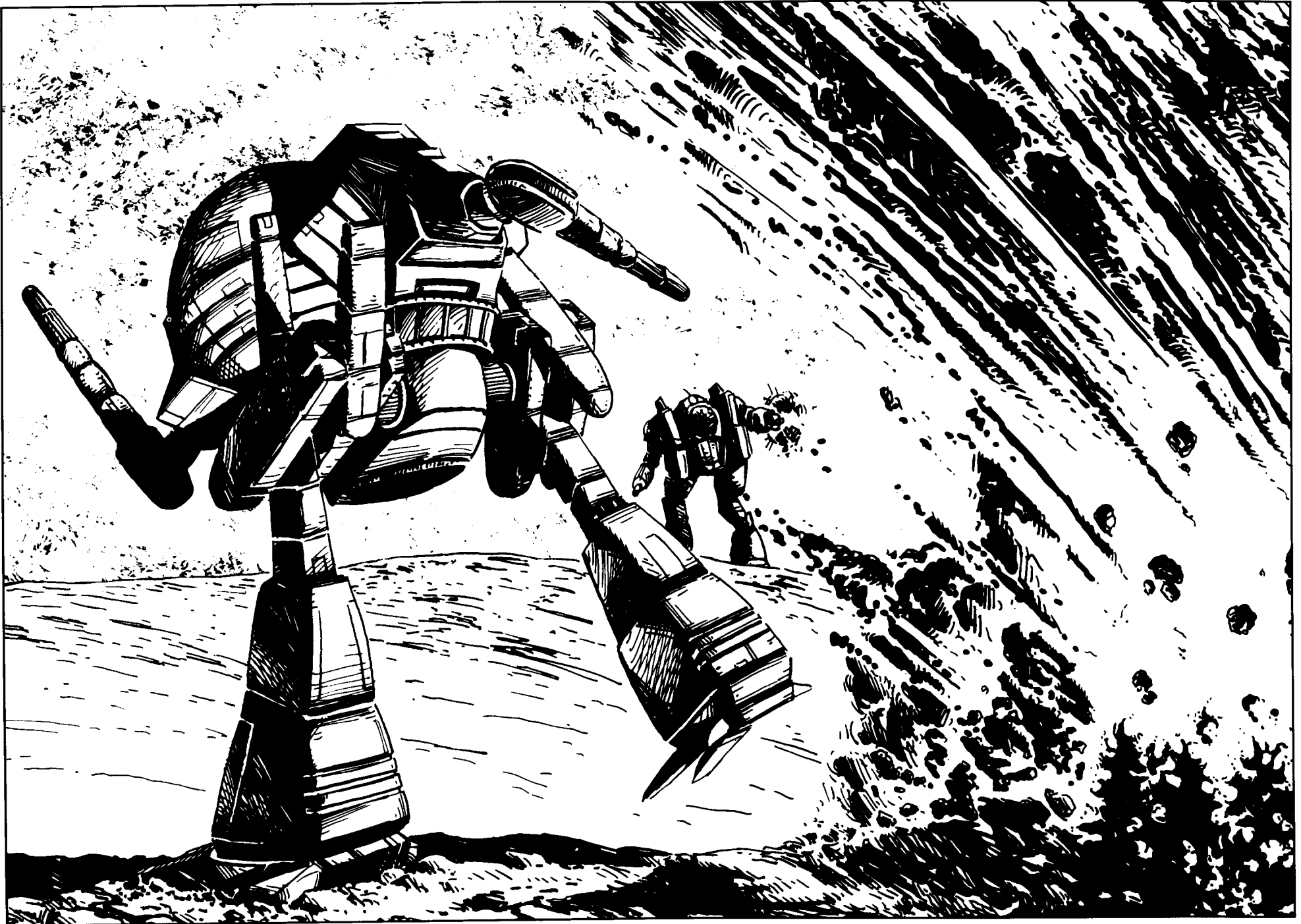

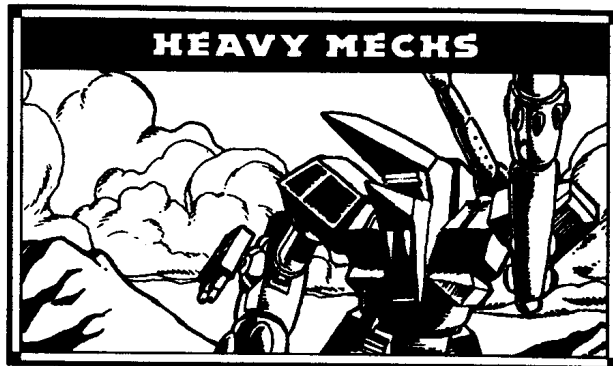

Mass: 60 tons

Chassis: Duralyte 314 Endo Steel

Power Plant: Vlar 300

Cruising Speed: 54 kph

Maximum Speed: 81 kph

Jump Jets: Chilton 365

Jump Capacity: 90 meters

Armor: Jolassa-325

Armament:

2 Sutel Precision Line Large Pulse Lasers

2 Martell Medium Lasers

Manufacturer: Free Worlds Defense Industries

Primary Factory: Gibson

Communications System: Datacom 50

with Guardian Electronic Countermeasures Suite

Targeting and Tracking System: Dynatec 1122

Overview:

During production of the *Hammer*, an engineer noticed that the new 'Mech would be suitably matched with another design under production, the *Stingray*. After reviewing the engineer's analysis, the Free Worlds League renamed the *Stingray* the *Anvil*.

When the *Anvil* is coupled with the *Hammer*, it produces an effective fighting duo that displays a broad weapons range and is mobile enough to cover terrain very quickly. First, the *Hammer's* long-range firepower "softens up" enemy 'Mechs, which then must face the wrath of the *Anvil's* deadly accurate large pulse lasers in close combat.

Many military planners in the Free Worlds League hope that enemy MechWarriors will come to fear the *Hammer* and *Anvil* combination in years to come.

Capabilities:

The *Anvil* utilizes some of the new technologies that have become available over the last few years, including endo steel internal structure, double heat sinks, and the Guardian electronic countermeasures package. The *Anvil's* main weaponry is a pair of large pulse lasers mounted on either side of the torso. Two Martell medium lasers supplement the main guns. The 'Mech has limited jump capability to give it more maneuverability in its close-combat role.

Deployment:

The *Anvil* and the *Hammer* have been inextricably intertwined ever since pilots discovered their compatibility as a team. Like the *Hammer*, the *Anvil* has been spotted in several companies throughout the Free Worlds League, especially in the Duchy of Andurien.

Variants:

The known suggestions concerning variants for the new *Anvil* are few. One idea is the elimination of the three jump jets for additional armor. Another is the downgrading of the large pulse lasers to standard pulse lasers, saving tonnage for the addition of more weapons or jump jets. Removal of the Guardian ECM suite has also been suggested, but that modification would drastically reduce the 'Mech's value.

Type: Anvil

Technology Base: Inner Sphere

Tonnage: 60

Equipment

Equipment		Mass
Internal Structure:	Endo Steel	3
Engine:	300	19
Walking MP:	5	
Running MP:	8	
Jumping MP:	3	
Heat Sinks:	12 [24]	2
Gyro:		3
Cockpit:		3
Armor Factor:	152	9.5

	Internal Structure	Armor Value
Head	3	9
Center Torso	20	24
Center Torso (rear)		7
R/L Torso	14	19
R/L Torso (rear)		7
R/L Arm	10	15
R/L Leg	14	15

Weapons and Ammo	Location	Critical	Tonnage
Large Pulse Laser	LT	2	7
Large Pulse Laser	RT	2	7
Medium Laser	H	1	1
Medium Laser	CT	1	1
Guardian ECM Suite	RT	2	1.5
Jump Jet	LL	1	1
Jump Jet	RL	1	1
Jump Jet	CT	1	1

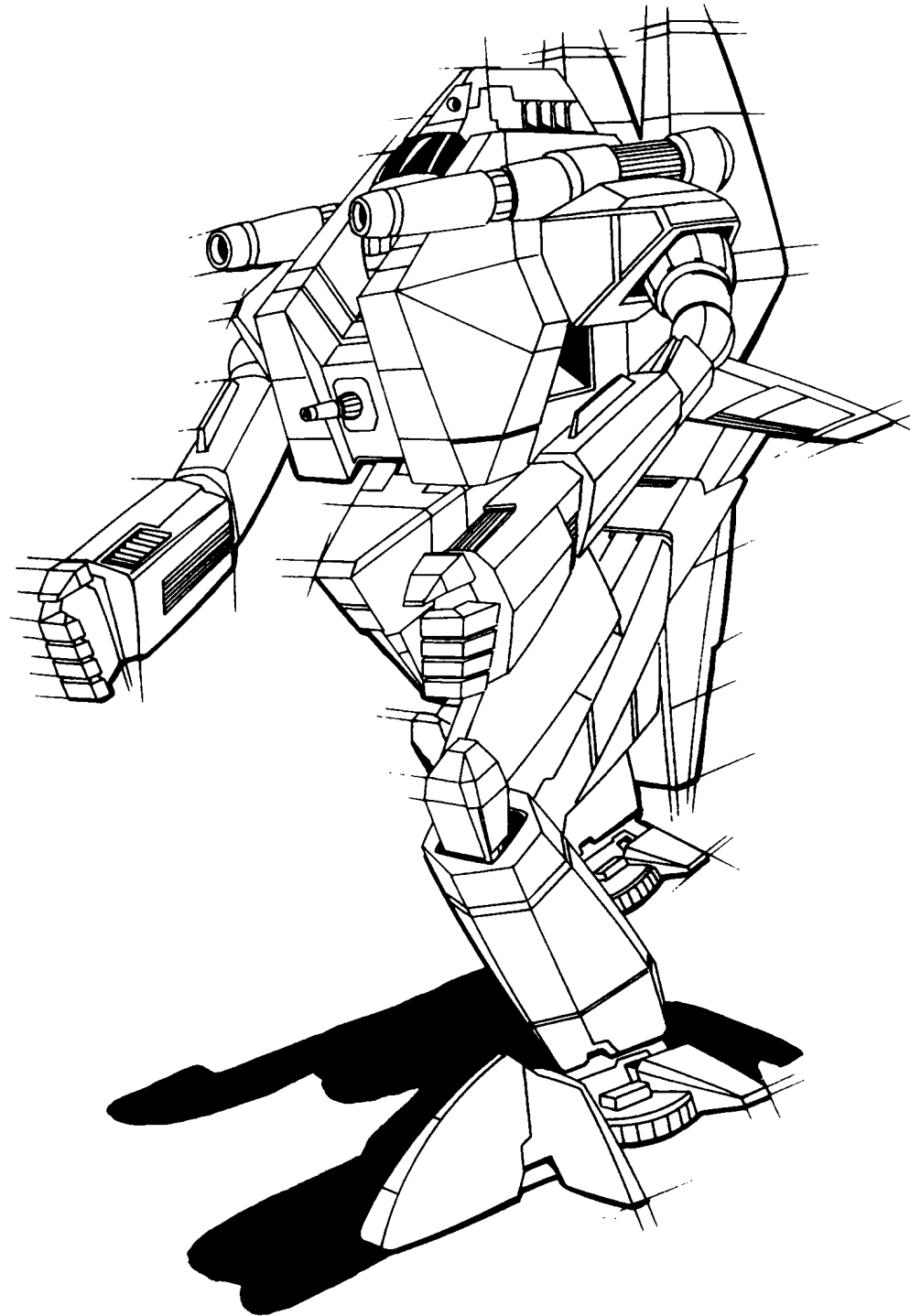

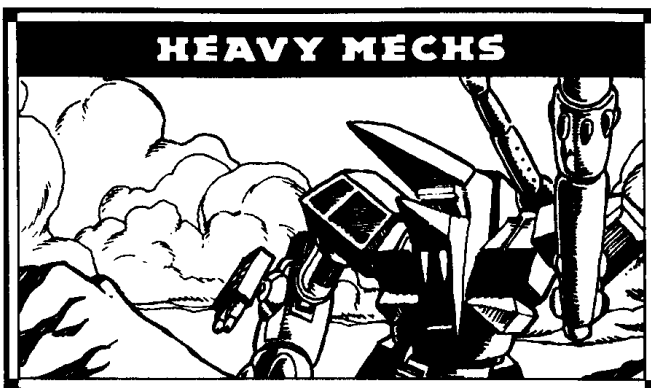

Mass: 65 tons

Chassis: Technicon Type H Endo Steel

Power Plant: Magna 260 XL

Cruising Speed: 43 kph

Maximum Speed: 65 kph

Jump Jets: Chilton 465

Jump Capacity: 120 meters

Armor: Maximilian 100

Armament:

1 Zeus Slingshot Gauss Rifle

1 Sutel Precision Line Large Pulse Laser

3 Diplan M3 Medium Lasers

1 Irian Weapons Works 60mm SRM-6 Rack

Manufacturer: Irian BattleMechs Unlimited

Primary Factory: Irian

Communications System: Irian Technologies

HMR-35s

Targeting and Tracking System:

Wasat Watchdog W100

Overview:

The *Tempest* was actually designed before the start of the Clan invasion into the Inner Sphere. At that time it mounted two PPCs as its main weapons. With the advent of new kinds of weaponry, the design was reworked.

Capabilities:

The *Tempest's* twin PPCs were replaced with a Zeus Slingshot Gauss rifle and a Sutel large pulse laser. The *Tempest* has three Diplan M3 medium lasers and an Irian Weapons Works 60mm SRM-6. The Gauss rifle is equipped with two tons of ammunition, for a total of 16 rounds of firing. The SRM-6 has one ton of ammunition, for a total of 15 rounds of firing.

The Irian designers have also incorporated the new Magna 260 XL engine, double heat sinks, and Technicon Type H endo steel chassis. The *Tempest* is jump-capable, moving up to 120 meters per firing, which allows it to keep pace with many lighter 'Mechs on the field.

Deployment:

Free Worlds military strategists are planning to deploy units composed exclusively of *Tempests* and the SHD-5M. The versatility of these designs allows a variety of mission types for the combination. Simulations show a high success ratio for the duo, but not enough *Tempests* are currently available to put this theory into practice.

So far, extensive testing of the *Tempest* has taken place on the planet Irian, home of the production facilities. The testing has been completed for various types of planetary conditions, ranging from polar to near molten extremes.

Commanders whose units have been assigned *Tempests* have been instructed to parade the unit in front of the civilian population and give it exposure whenever available for the first month of its arrival. These orders suggest that the desired effect is to boost the loyalty of the local populace and instill the belief that the enemies of the state will view the new 'Mech with trepidation.

Type: **Tempest**

Technology Base: Inner Sphere

Tonnage: 65

Equipment

		Mass
Internal Structure:	Endo Steel	3.5
Engine:	260 XL	7
Walking MP:	4	
Running MP:	6	
Jumping MP:	4	
Heat Sinks:	11 [22]	1
Gyro:		3
Cockpit:		3
Armor Factor:	200	12.5

	Internal Structure	Armor Value
Head	3	9
Center Torso	21	32
Center Torso (rear)		7
R/L Torso	15	24
R/L Torso (rear)		6
R/L Arm	10	18
R/L Leg	15	28

Weapons and Ammo	Location	Critical	Tonnage
Gauss Rifle	RA	7	15
Ammo (Gauss) 16	RA	2	2
Large Pulse Laser	LA	2	7
Medium Laser	H	1	1
Medium Laser	CT	1	1
Medium Laser	CT	1	1
SRM 6	LT	2	3
Ammo (SRM) 15	LT	1	1
Jump Jets	LL	2	2
Jump Jets	RL	2	2

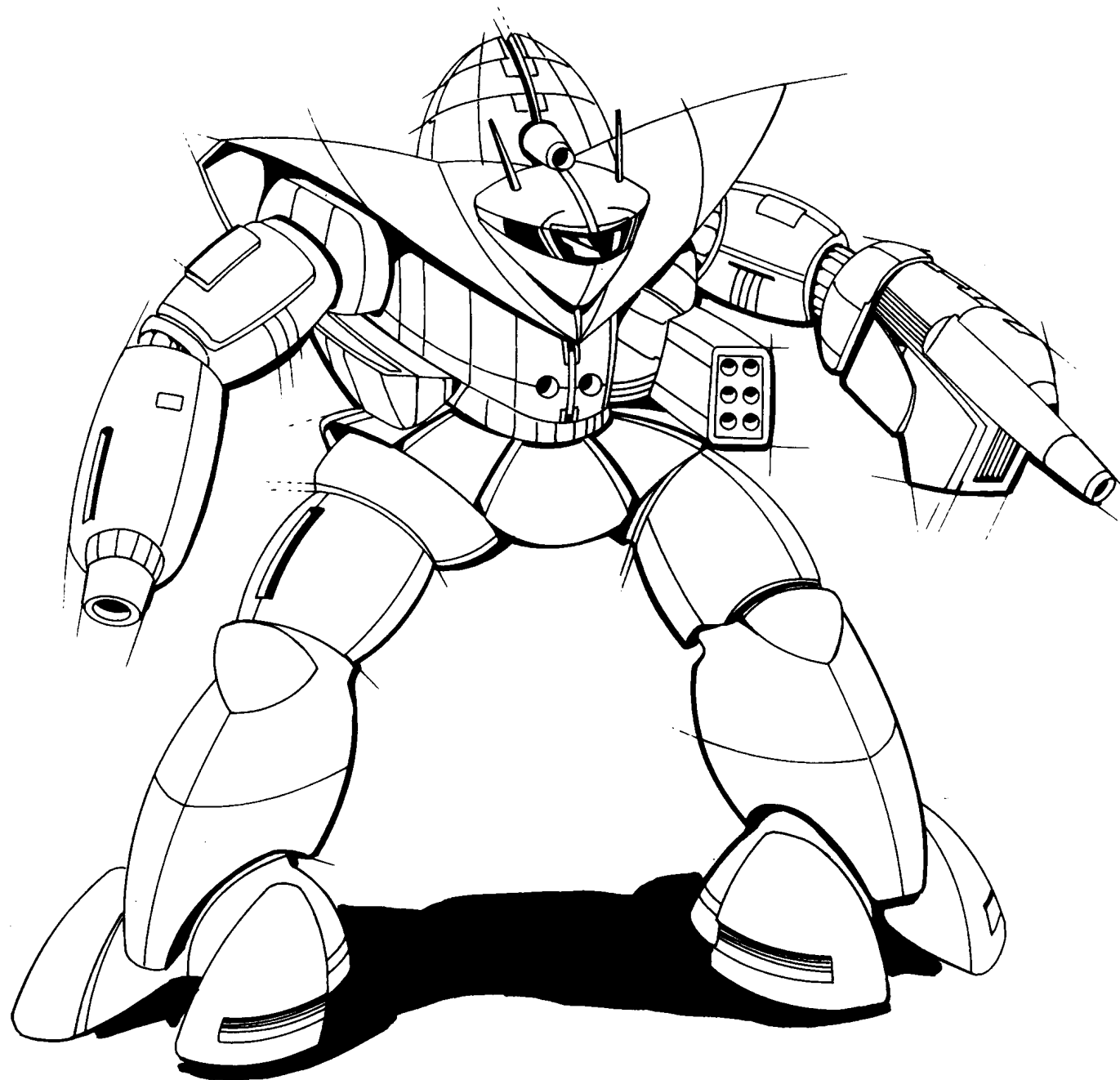

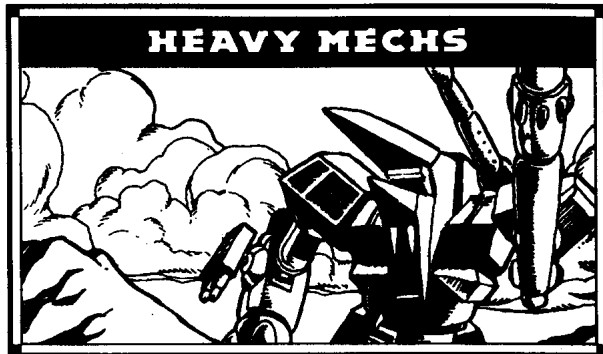

Mass: 70 tons
Chassis: Luthien DAI
Power Plant: Magna 350 XL
Cruising Speed: 54 kph
Maximum Speed: 86.4 kph
Jump Jets: None
Jump Capacity: None
Armor: Starshield A with CASE
Armament:
 1 Lord's Light 2 Extended Range PPC
 2 Imperator Ultra-5 Autocannon
 1 LongFire V LRM-5 Rack
 1 Diverse Optics Type 20 Medium Laser
Manufacturer: Luthien Armor Works
Primary Factory: Luthien
Communications System: Sipher Security Plus
Targeting and Tracking System: Matabushi Sentinel

Overview:

During the Clan invasion, the DCMS has been faced with a more mobile enemy, whose firepower and heat dispersal capabilities are also superior. Plans were made to produce a new, more maneuverable, fire-support 'Mech to supplement or replace the aging *Archer* and others of its kind.

Luthien Armor Works proposed a revolutionary design centering on the new ultra autocannon. Rather than relying on the at times unreliable indirect-fire long-range missile systems, Luthien used state-of-the-art direct-fire weaponry, including the Lord's Light 2 extend-

ed range PPC. The 'Mech was named *Daikyu*, after the ancient Japanese longbow that could be fired from horseback. The *Daikyu* lives up to its name, providing a mobile long-range support 'Mech to Kurita forces.

Capabilities:

The *Daikyu* is intended to provide long-range fire support to medium 'Mech units. It is equipped with a Magna 350 XL engine, giving the 'Mech greater maneuverability than others of its class. This maneuverability should help the *Daikyu* keep up with Clan forces.

Each arm of the *Daikyu* mounts an Imperator Ultra-5 autocannon. When fired together at high speed, they create a devastating long-range barrage for very little heat. The only drawback with this system is that it can consume ammunition very quickly. Pilots who are used to the standard autocannon will assume that two tons of ammunition is more than enough, only to find themselves with an empty ammo berth in less than two minutes of action! The right torso is fitted with Cellular Ammunition Storage Equipment, protecting the pilot from ammo explosions.

Supplementing the autocannon is a Lord's Light 2 extended-range PPC mounted in the left arm. This item is very reliable, as any PNT-10K *Panther* pilot can attest. MechWarriors piloting the *Daikyu* are warned about the enormous heat buildup associated with firing this type of PPC. It is intended for use as a backup weapon, in case of autocannon shutdown or ammo loss.

Secondary weapon systems include the LongFire V LRM-5 rack and a Diverse Optics Type 20 medium laser. Commanders must be sure to deploy this 'Mech appropriately. Its lack of short-range weapons makes it a poor candidate for close-in fighting, and reckless pilots may find themselves overheated if they use the PPC too much, or out of ammunition if they rely on the autocannon alone. A prudent and skilled MechWarrior can use the *Daikyu* as it was intended, supporting its lancemates from afar.

Deployment:

It is hoped that this design, among others, will help relieve the DCMS of its reliance on ComStar 'Mechs acquired since the Fourth Succession War. All the *Daikyus* currently available remain on Luthien, mainly in service with the First Genyosha and Seventh Sword of Light, although all units present on Luthien have at least one *Daikyu* among their fire-support 'Mechs.

Type: **Daikyu**
 Technology Base: Inner Sphere
 Tonnage: 70

Equipment		Mass
Internal Structure:	Endo Steel	3.5
Engine:	350 XL	15
Walking MP:	5	
Running MP:	8	
Jumping MP:	0	
Heat Sinks:	11 [22]	1
Gyro:		4
Cockpit:		3
Armor Factor:	192	12
	<i>Internal Structure</i>	<i>Armor Value</i>
Head	3	9
Center Torso	22	27
Center Torso (rear)		10
R/L Torso	15	20
R/L Torso (rear)		8
R/L Arm	11	19
R/L Leg	15	26

Weapons and Ammo	Location	Critical	Tonnage
ER PPC	LA	3	7
Ultra AC/5	RA	5	9
Ultra AC/5	LA	5	9
Ammo (Ultra) 40	RT	2	2
LRM 5	LT	1	2
Ammo (LRM) 24	RT	1	1
CASE	RT	1	.5
Medium Laser	LT	1	1

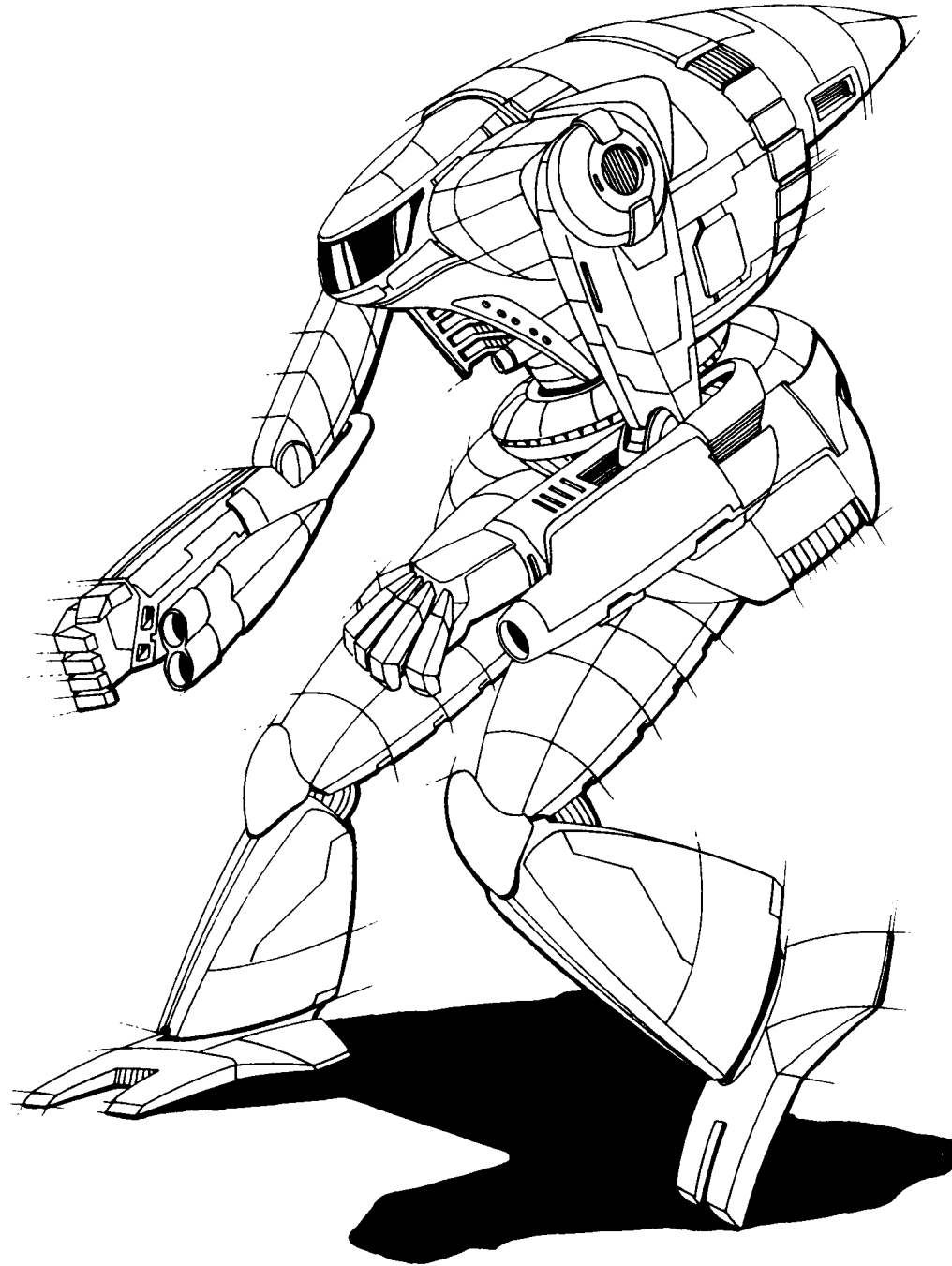

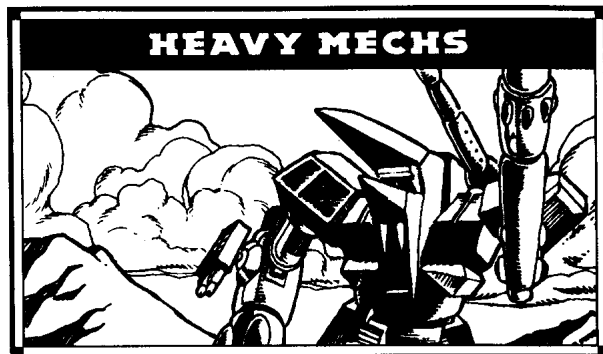

Mass: 70 tons
Chassis: BLKWL-52gls
Power Plant: Vox 280
Cruising Speed: 43 kph
Maximum Speed: 65 kph
Jump Jets: Geotec 300
Jump Capacity: 90 meters
Armor: Valiant Lamellor
Armament:
 1 Tiegart Magnum Extended Range PPC
 2 Sunglow Large Lasers
 2 Magna Quasar Medium Pulse Lasers
 1 Magna Starglow Small Laser
Manufacturer: Blackwell Heavy Industries
Primary Factory: Outreach
Communications System: Dalban Micronics
Targeting and Tracking System: Dalban HiRez II

Overview:

The *Gallowglas* is a new BattleMech design recently offered by Blackwell Heavy Industries. The manufacturer calls it a successful marriage of proven technologies and modern innovation. Indeed, it may prove to be so. The *Gallowglas's* array of energy weaponry makes it a formidable foe at long range, and its effectiveness only increases at shorter ranges, a vital necessity against the Clan threat.

It is believed that the model offered for sale by Blackwell is a variation on the *Gallowglas* 'Mech known to be operating in limited numbers with Wolf's Dragoons. Most likely, Blackwell is supplying the

Dragoons with their *Gallowglas* 'Mechs, and any difference in the machines is almost certainly due to the use of proprietary technologies that the Dragoons are unwilling to share with the Inner Sphere. Despite that, even a stripped-down *Gallowglas* is a welcome addition to the armories of the Inner Sphere.

Capabilities:

The *Gallowglas* is built on a chassis incorporating endo steel structural members armored with a multi-layered defense of Valiant ceramet plate. Though of typical speed for its weight class, its Geotec 300 jump jets allow it a mobility often lacking in a heavy 'Mech.

The primary armament is an extended-range PPC, the recently reintroduced Tiegart Magnum, backed up by an impressive laser array.

Comparison of electronic emission records and external features such as antennae arrays indicate that Blackwell has not stinted in supplying first-rate electronics. The communications array is from Dalban Micronics, an excellent and proven system easily adaptable to C³ computer interlocks.

Deployment:

Early orders placed by House Kurita and the Lyran Commonwealth show that those who face the Clans appreciate this design. Revised production schedules indicate that the new BattleMech is so much in demand that Blackwell may not be able to keep up.

Variants:

From all reports, the *Gallowglas* in service with Wolf's Dragoons differs from the commercial model. Most likely it carries three less heat sinks and has a pair of extended-range medium lasers and a pair of small pulse lasers of Clan-level technology. It is also faster; a cruising speed of 54 kph is reported.

Blackwell sales agents are soliciting orders for a GAL-2GLS. This Mark 2 version would replace the main armament with a Blackwell Fury Gauss rifle and would carry two tons of ammunition in a CASE-protected bay. The elimination of the PPC, one of the medium pulse lasers, and the small laser reduces the

machine's heat debt dramatically; all extra heat sinks are dropped. The Mark 2 is clearly a BattleMech dedicated to a purely anti-'Mech role.

Type: **Gallowglas**

Technology Base: Inner Sphere

Tonnage: 70

Equipment		Mass
Internal Structure:	Endo Steel	3.5
Engine:	280	16
Walking MP:	4	
Running MP:	6	
Jumping MP:	3	
Heat Sinks:	18 [36]	8
Gyro:		3
Cockpit:		3
Armor Factor:	192	12
	<i>Internal Structure</i>	<i>Armor Factor</i>
Head	3	9
Center Torso	22	30
Center Torso (rear)		9
R/L Torso	15	23
R/L Torso (rear)		7
R/L Arm	11	20
R/L Leg	15	22
Weapons and Ammo	Location	Critical Tonnage
ER PPC	RA	3 7
Large Laser	RT	2 5
Large Laser	RT	2 5
Medium Pulse Laser	LA	1 2
Medium Pulse Laser	LA	1 2
Small Laser	H	1 .5
Jump Jet	RL	1 1
Jump Jet	LL	1 1
Jump Jet	CT	1 1

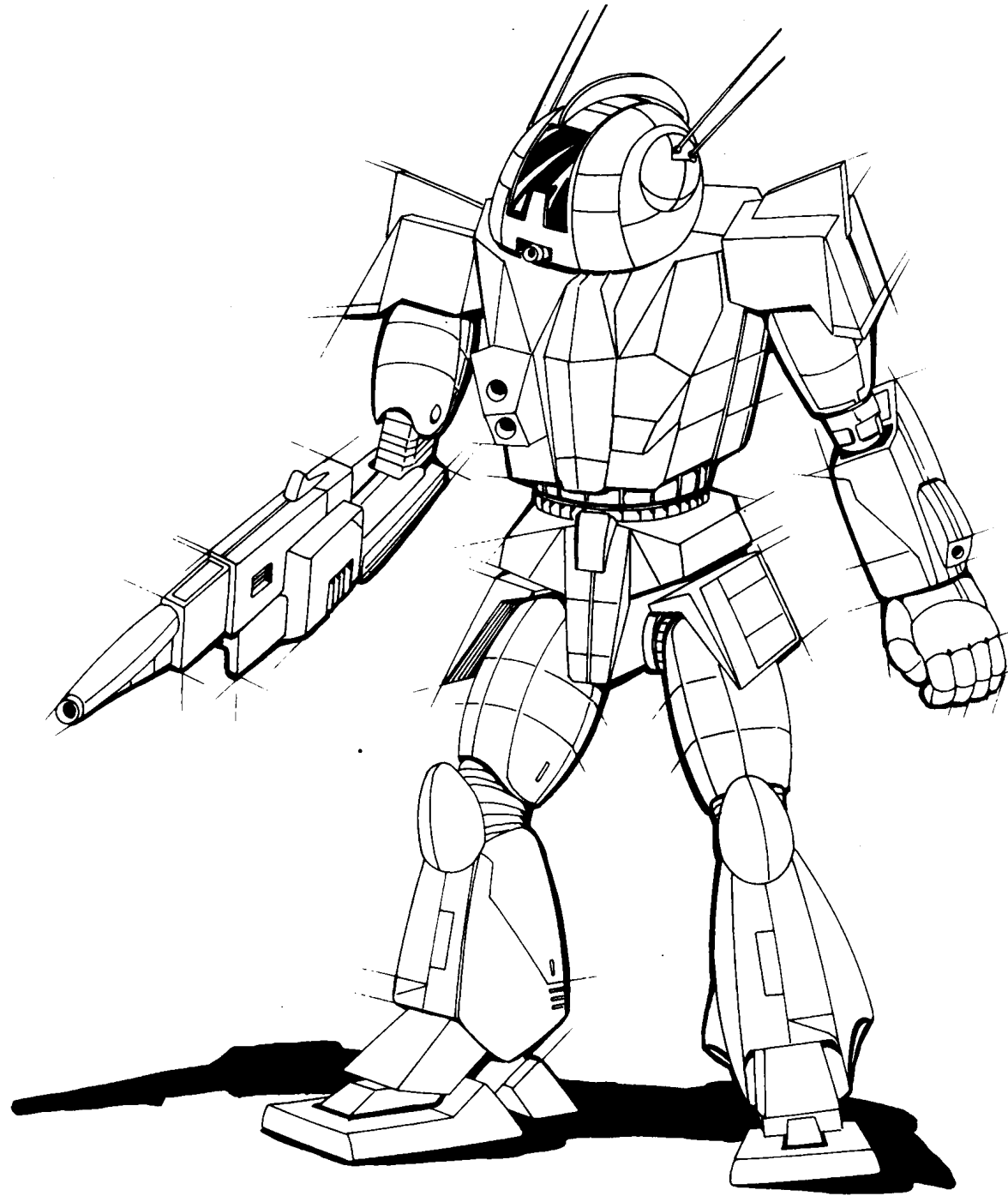

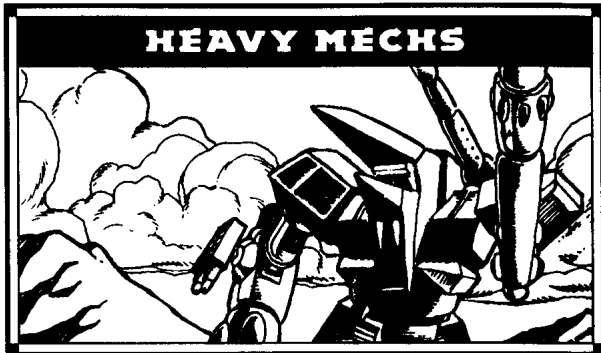

Mass: 70 tons
Chassis: Northrup-502
Power Plant: Magna 350 XL
Cruising Speed: 54 kph
Maximum Speed: 86.4 kph
Jump Jets: None
Jump Capacity: None
Armor: Aldis Heavy Ferro-Fibrous
Armament:
 1 Fusigon Model XI Extended Range PPC
 1 Imperator Code Red LB 10-X Autocannon
 1 Holly Streak SRM-2 Rack
 1 Burow Anti-Missile System
 2 Martell Small Pulse Lasers
 1 Aberdovey Medium Pulse Laser
Manufacturer: Kali Yama/Alphard Trading Corp.,
 Kali Yama Weapons Industries
Primary Factory: Kendall, Kalidasa
Communications System: Irian Orator-5K
Targeting and Tracking System: Irian 511

Overview:

In commissioning the design of the *Hercules*, House Marik was seeking a 'Mech offering a strong balance between mobility and firepower. The goal was to provide a wide range of weapons for a BattleMech that could serve a multitude of roles.

Capabilities:

The *Hercules* is intended to be a mobile firing platform. Mounting a new Magna 350 XL fusion engine,

this heavy BattleMech moves at a standard speed of 54 kph, one of the few of this weight class to be able to move so fast.

The 'Mech's defensive capabilities are equally impressive. Equipped with eleven tons of Aldis ferro-fibrous weave armor, the *Hercules* can weather even the most deadly volleys, whether from Clan OmniMechs or their Inner Sphere counterparts. With the Burow anti-missile system mounted in the center body, the *Hercules* can also defeat incoming missile attacks.

Though its defensive capabilities are impressive, the 'Mech's firepower is equally impressive. Its primary weapon is the reliable Fusigon Model XI extended range PPC.

Supporting the PPC is an Imperator Code Red LB 10-X autocannon. In addition to these two mainstays of firepower is a Streak SRM-2 and a medium pulse laser.

The only modification to the original design is the addition of two rear-mounted Martell pulse lasers. Designed to fend off Elemental swarming attacks, these small lasers have proven to be a significant selling feature of this 'Mech.

Despite its impressive array of defenses and weapons, the *Hercules* has been plagued by a number of minor problems. The electrical systems seem to overload when hit by PPC fire. Despite the addition of several damper circuits, some MechWarriors still complain of the problem, but Kali Yama officials insist that the flaw has been corrected.

Deployment:

The Outworlds Alliance has purchased two *Hercules* 'Mechs for their arsenal. This is a unique move for a Periphery state, given the higher cost of the *Hercules* over the older-technology 'Mechs that are usually sold to these governments. Some experts believe that the Alliance has purchased the *Hercules* 'Mechs purely for the purpose of dismantling them and analyzing their advanced technology.

Perhaps the best testing ground for this 'Mech so far has been its participation in the games on Solaris VII. Kali Yama Weapons Industries representatives

have persuaded at least two stables or cooperatives to make use of the *Hercules*. In all matches where it competed, the *Hercules* fared quite well.

Type: Hercules
Technology Base: Inner Sphere
Tonnage: 70

Equipment		Mass
Internal Structure:		7
Engine:	350 XL	15
Walking MP:	5	
Running MP:	8	
Jumping MP:	0	
Heat Sinks:	12 [24]	2
Gyro:		4
Cockpit:		3
Armor Factor:	197	11
	<i>Internal Structure</i>	<i>Armor Value</i>
Head	3	9
Center Torso	22	34
Center Torso (rear)		10
R/L Torso	15	22
R/L Torso (rear)		8
R/L Arm	11	18
R/L Leg	15	24

Weapons and Ammo	Location	Critical	Tonnage
ER PPC	RT	3	7
LB 10-X AC	RA	6	11
Ammo (LB-X) 20	RT	2	2
Streak SRM 2	LT	1	1.5
Ammo (Streak) 50	LT	1	1
Anti-Missile System	CT	1	.5
Ammo (Anti-Missile) 12	LT	1	1
Small Pulse Laser	RT (R)	1	1
Small Pulse Laser	LT (R)	1	1
Medium Pulse Laser	LA	1	2

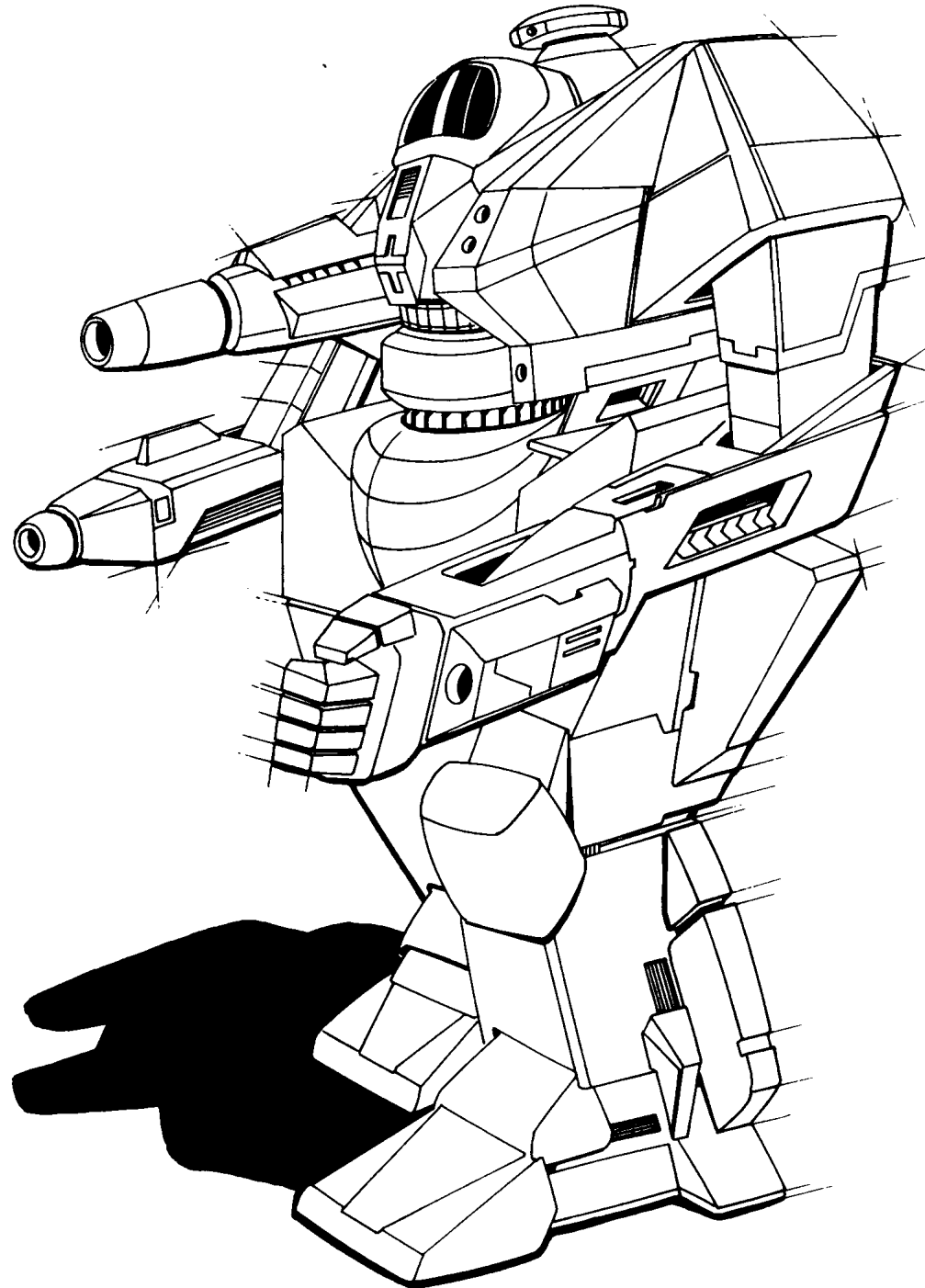

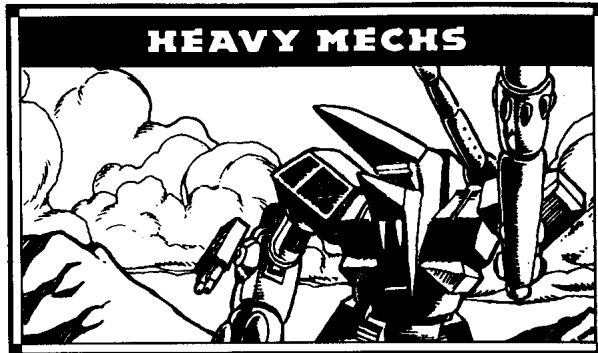

Mass: 70 tons

Chassis: Hollis Mark III

Power Plant: Magna 350 XL

Cruising Speed: 54 kph

Maximum Speed: 81 kph

Jump Jets: None

Jump Capacity: None

Armor: Durallex Heavy with CASE

Armament:

1 Kali Yama Big Bore Autocannon

1 Sian/Ceres Jaguar LRM-5 Rack

3 Ceres Arms Model W Medium Pulse Lasers

Manufacturer: Ceres Metals Industries

Primary Factory: Capella

Communications System: CeresCom Model 21-Rs

Targeting and Tracking System: C-Apple Churchill

Overview:

Following the Fourth Succession War, the Capellan Confederation was in a particularly poor position because the Davion forces had captured so many of its 'Mech production facilities in that war. Ceres Metals Industries was one of the few BattleMech factories left to the Capellan military machine.

After producing numerous 'Mechs to fill the holes in existing units, Ceres was able to expand its facilities. With so much new technology on the scene in the wake of the Clan invasion, acquiring some of it was vital to the existence of the Confederation. Eventually, the information came to the Capellans through the Free Worlds League.

The first new 'Mech to be produced from the new technology was the *Thunder*. The designers wanted a 'Mech that would deliver plenty of punch without sacrificing maneuverability on the battlefield. Romano Liao awarded the designers a citation of merit when the new 'Mech walked out of assembly and into the ranks of her military.

Capabilities:

The THR-1L *Thunder* is a 70-ton heavy 'Mech. It is the Capellan Confederation's first 'Mech design put into production following the Clan invasion.

The Kali Yama Big Bore autocannon is the 'Mech's main weapon, with three tons of ammunition for a total of 15 rounds of firing. Complementing the AC-20 is an LRM-5 rack in the left torso area. It can fire 24 rounds, and is provided with one ton of ammo. The *Thunder* also has three Ceres Arms Model W medium pulse lasers for close-combat support. Both the autocannon and the missile ammo are protected by CASE.

The *Thunder* can move up to 81 kph, but is not jump-capable. Its Magna 350 XL engine provides as much power as a standard 350, but at half the weight. The 'Mech also has eleven double heat sinks to help dissipate heat from the weapon systems and from movement.

The *Thunder* is heavily armored for a 70-ton 'Mech, but the Capellans are banking on the *Thunder* to engage 'Mechs up to half again its weight on the battlefield.

Because of the paranoia in the Capellan court, the designers believed it was best to use only parts that could be produced in the Confederation. New and found technologies were implemented in the *Thunder*, but all such finds were not available for use by the production team. Different 'Mechs produced in the future should have additional improvements. Recent negotiations with the Free Worlds League may be especially fruitful in this regard.

Deployment:

As of this writing, only three *Thunder* 'Mechs have been spotted in the field. It is not known how many have been produced so far, nor if the three that have been observed have been intentionally exposed.

No confrontations with the *Thunder* have been reported as yet. The three 'Mechs spotted are on planets where a direct confrontation seems unlikely. It is assumed that the Capellans will use the *Thunder* to replace 'Mechs in front-line units.

Type: Thunder

Technology Base: Inner Sphere

Tonnage: 70

Equipment

		Mass
Internal Structure:		7
Engine:	350 XL	15
Walking MP:	5	
Running MP:	8	
Jumping MP:	0	
Heat Sinks:	11 [22]	1
Gyro:		4
Cockpit:		3
Armor Factor:	216	13.5
	<i>Internal Structure</i>	<i>Armor Value</i>
Head	3	9
Center Torso	22	34
Center Torso (rear)		9
R/L Torso	15	23
R/L Torso (rear)		7
R/L Arm	11	22
R/L Leg	15	30

Weapons and Ammo	Location	Critical	Tonnage
AC/20	RT/RA	10	14
Ammo (AC) 15	LT	3	3
CASE	LT	1	.5
LRM 5	LT	1	2
Ammo (LRM) 24	LT	1	1
Medium Pulse Laser	CT	1	2
Medium Pulse Laser	LT	1	2
Medium Pulse Laser	RT	1	2

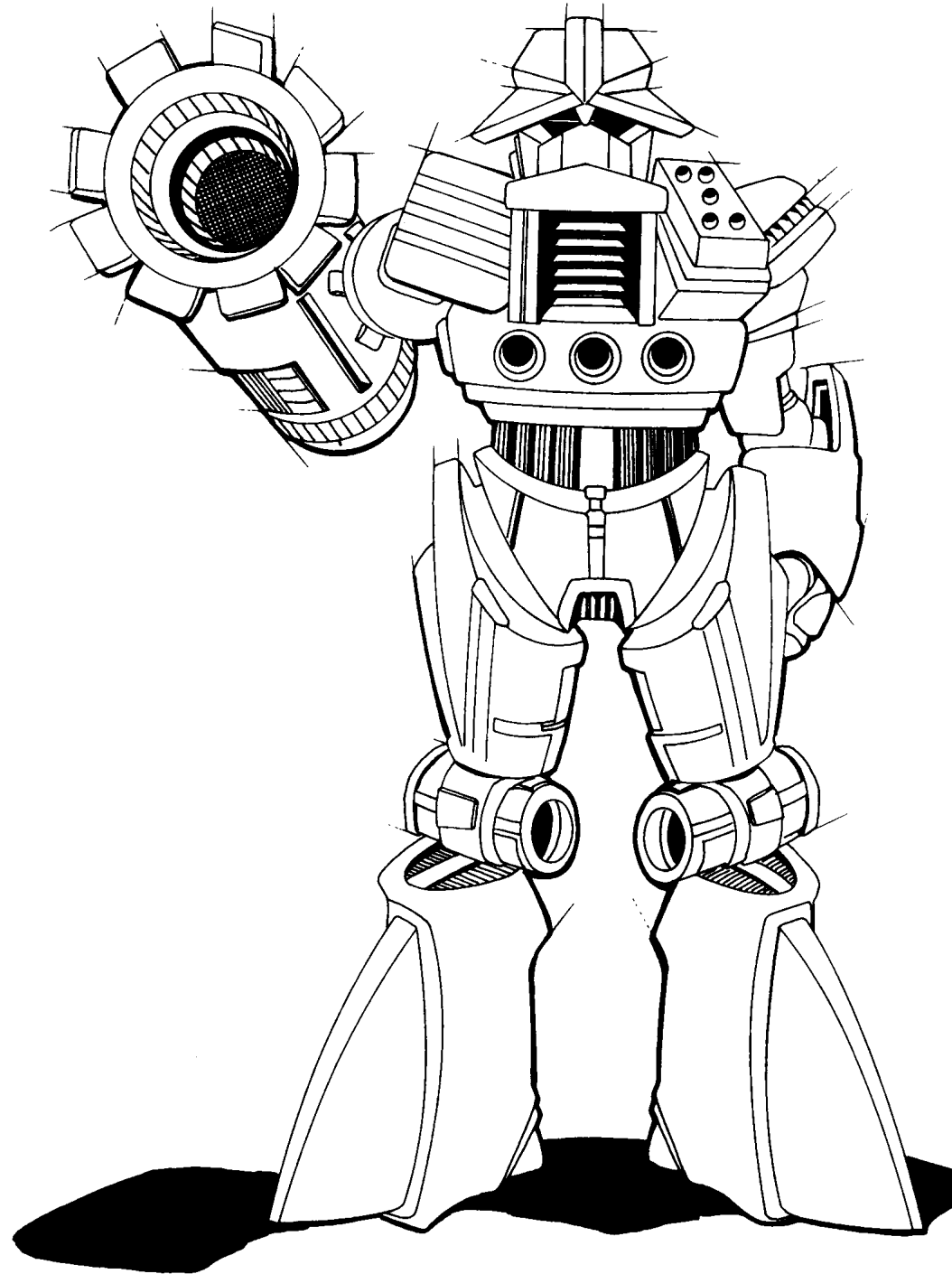

BNDR-01A BANDERSNATCH

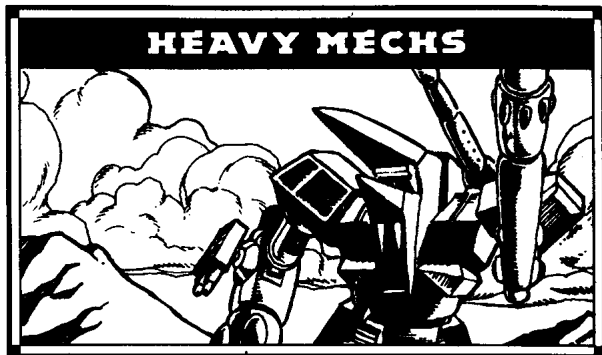

Mass: 75 tons
Chassis: Bander Custom 1
Power Plant: Vlar 300 XL
Cruising Speed: 43.2 kph
Maximum Speed: 64.8 kph
Jump Jets: None
Jump Capacity: None
Armor: Valiant Chainmail
Armament:
 2 Armstrong Class-B ClusterGuns
 6 Magna Mark II Medium Lasers
 3 Holly LRM-5 Racks
Manufacturer: Bander BattleMechs
Primary Factory: Terra Firma
Communications System: Winston Mega
 Boozee Mark IX
Targeting and Tracking System: Winston
 Sidewinder

Overview:

Felifious Bander was the chief tech of the late Twelfth Star Guard. For him, fighting the Clans seemed impossible with 3025 technology, so Bander changed careers. He entered the BattleMech refitting business as President and CEO of Bander BattleMechs. Already possessed of a considerable reputation, he was able to convince many former mercenary techs to join his firm. Quickly, they established themselves as a premier enterprise with competitive prices.

The firm's first original BattleMech is a Felifious Bander creation. Having seen the Clans in action, and

reviewed the most popular 'Mech refits of his clients, Bander decided that he knew what the situation required. Thus was the BNDR-01A *Bandersnatch* born.

Capabilities:

Bander considered the *Marauder's* chassis the most distinctive of all 'Mechs, and so he designed and built his 'Mech with a similar profile and style.

The design team equipped the 'Mech with the best rediscovered technology, installing two Armstrong Class-B ClusterGuns, which are perfect copies of the Star League Lubalin LB 10-X autocannon. Three Holly LRM-15 racks give the 'Mech additional long-range firepower. Because the 'Mech requires so much ammunition to justify the use of the heavy cannons, the torso ammo bins were equipped with CASE technology to extend the life expectancy of the 'Mech.

To make sure the 'Mech is not under-gunned after expending all its ammo, six Magna Mark II medium lasers were added; two to each arm and a pair facing the rear. During the initial test firings, both rear-firing lasers unexpectedly melted their heat jackets. When he was not able to determine the cause of the meltdown, Bander had the lasers raised half a meter, but field technicians should keep a close eye on the condition of the heat jackets.

Deployment:

So far, perhaps only a half-dozen of these 'Mechs are in existence, but Bander BattleMechs claims that the *Bandersnatch* is the most versatile design in the Inner Sphere and predicts it will be very popular for special-purpose applications. Only time will tell if Felifious Bander's answer to the Clans is a success.

Variants:

Unless a major company takes over production of the *Bandersnatch*, every 'Mech produced by Bander BattleMechs will be a variation of its basic design. The company claims to be able to build a single *Bandersnatch* or variant in approximately ten months, depending on the required modifications.

Type: *Bandersnatch*
Technology Base: Inner Sphere
Tonnage: 75

Equipment		Mass
Internal Structure:		7.5
Engine:	300 XL	9.5
Walking MP:	4	
Running MP:	6	
Jumping MP:	0	
Heat Sinks:	10 [20]	0
Gyro:		3
Cockpit:		3
Armor Factor:	176	11
	<i>Internal Structure</i>	<i>Armor Value</i>
Head	3	9
Center Torso	23	23
Center Torso (rear)		10
R/L Torso	16	23
R/L Torso (rear)		8
R/L Arm	12	18
R/L Leg	16	18

Weapons and Ammo	Location	Critical	Tonnage
Medium Laser	LA	1	1
Medium Laser	LA	1	1
LB 10-X	LA	6	11
Ammo (LB-X) 20	LT	2	2
CASE	LT	1	.5
Medium Laser	RA	1	1
Medium Laser	RA	1	1
LB 10-X	RA	6	11
Ammo (LB-X) 20	RT	2	2
CASE	RT	1	.5
Medium Laser	CT (R)	1	1
Medium Laser	CT (R)	1	1
LRM 5	RT	1	2
Ammo (LRM) 24	RT	1	1
LRM 5	LT	1	2
Ammo (LRM) 24	LT	1	1
LRM 5	H	1	2

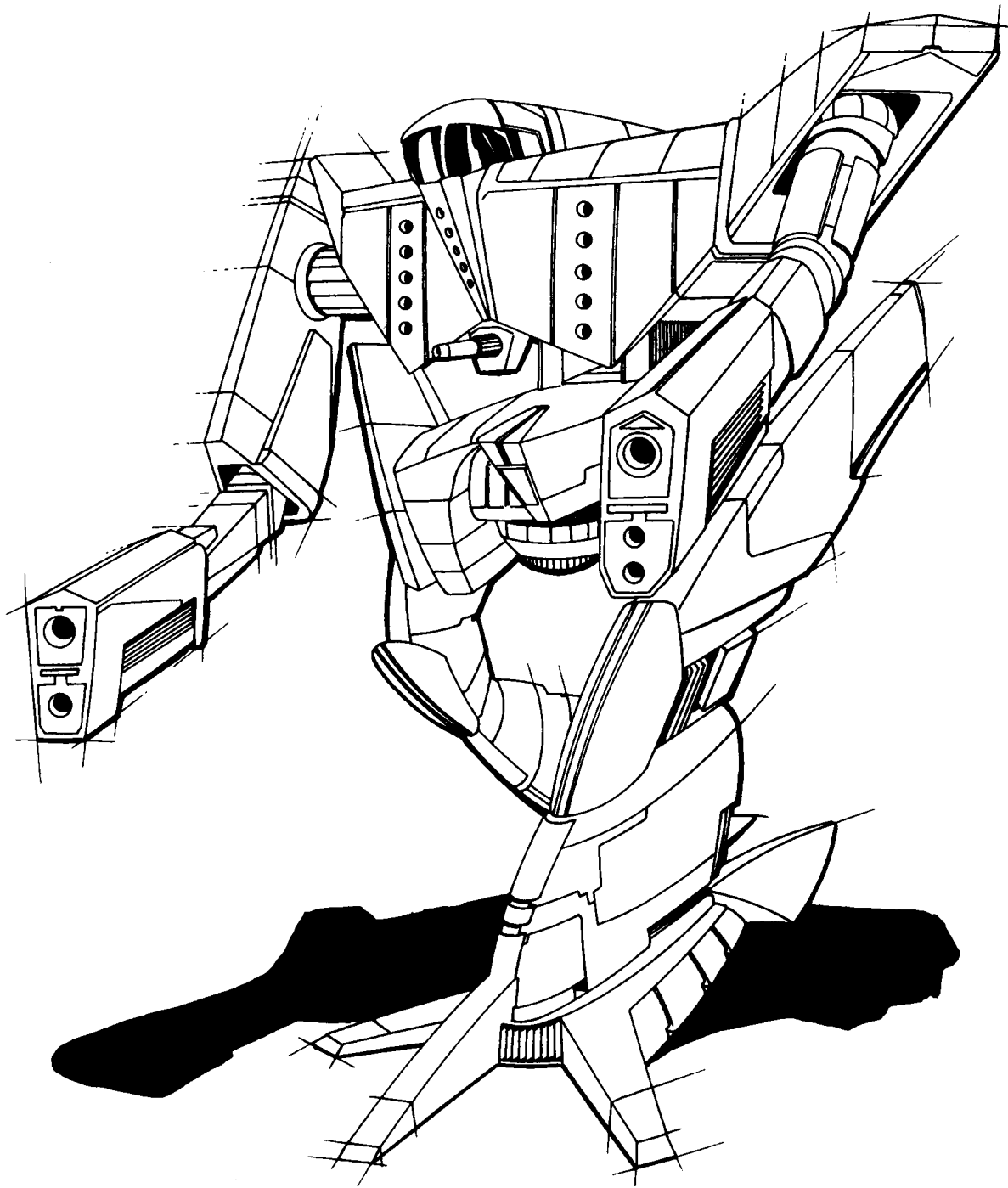

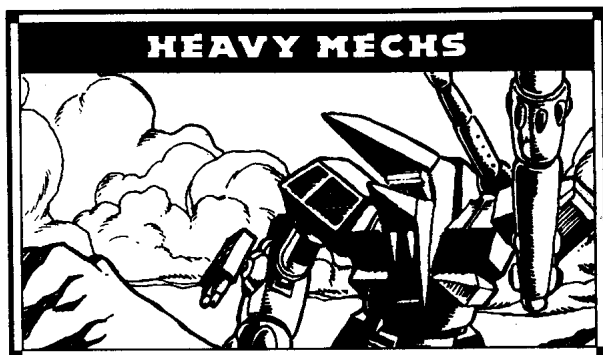

Mass: 75 tons

Chassis: McLarren-75B

Power Plant: GM 375 XL

Cruising Speed: 57.1 kph

Maximum Speed: 86.4 kph

Jump Jets: Devil A7

Jump Capacity: 150 meters

Armor: Valiant Chainmail

Armament:

1 Defiance 1001 Extended Range PPC

4 Defiance B3M Medium Lasers

1 Poland Main Model A Gauss Rifle

Manufacturer: TharHes Industries

Primary Factory: Tharkad

Communications System: TharHes Calliope ZE-2

Targeting and Tracking System: TharHes Ares-7i

Overview:

Despite the destruction of the Falcon Guards at the hands of Kai Allard-Liao on Twycross, Clan Jade Falcon has had a field day with Federated Commonwealth troops. During the initial thrust of the invasion, the Falcons easily swept aside all who had opposed them. Frustrated F-C commanders searched in vain for something that would turn the tide of battle. One suggestion came from the Prince of the Federated Suns.

Hanse Davion, shortly before his tragic death in 3052, wanted to beat the Falcons at their own game,

so he called for a design that would "tame the Jade Falcons." It is not known if the name *Falconer* was originally a joke, but the name has stuck to the 'Mech. Ironically, the *Falconer* title also applies to Jade Falcon training officers, a fact of which no one in the Inner Sphere was previously aware.

Capabilities:

When TharHes Industries accepted the contract to design the 'Mech, they were aware of the difficulties of the task. The specifications called for a 'Mech capable of taking on a Clan OmniMech in combat. Though unable to produce OmniMechs, the firm's designers opted to copy a popular Clan design. The TharHes team chose the *Thor*, an OmniMech popular among Jade Falcon warriors, as the basis for the *Falconer*. The spacious Orion chassis, built using endo steel processes, was selected for the skeleton of the 'Mech.

The *Falconer* makes excellent use of rediscovered Star League technology. The GM 375 XL provides a top speed of 86.4 kph. Coupled with the 'Mech's jump capability, the *Falconer* is one of the most mobile heavy BattleMechs in the Inner Sphere. The Valiant Chainmail armor also provides solid protection for the machine.

The Poland Main Model A Gauss rifle and the Defiance 1001 ER PPC provide accurate and deadly long-range firepower. For close-range combat, the *Falconer* boasts four reliable Defiance medium lasers. Ten double-strength heat sinks dispose of the heat produced by its weapons, but this number is not sufficient for continual barrage fire.

Deployment:

The first run of *Falconers* has been assigned to the Davion Heavy Guards. This is hardly surprising, considering the unit's well-known vendetta against the Jade Falcons. The Guards are expected to attack the planet of Black Earth in a desperate attempt to win it back from their adversaries.

Type: Falconer

Technology Base: Inner Sphere

Tonnage: 75

Equipment

		Mass
Internal Structure:	Endo Steel	4
Engine:	375 XL	19.5
Walking MP:	5	
Running MP:	8	
Jumping MP:	5	
Heat Sinks:	10 [20]	0
Gyro:		4
Cockpit:		3
Armor Factor:	184	11.5
	Internal Structure	Armor Value
Head	3	9
Center Torso	23	31
Center Torso (rear)		8
R/L Torso	16	21
R/L Torso (rear)		6
R/L Arm	12	19
R/L Leg	16	22

Weapons and Ammo	Location	Critical	Tonnage
ER PPC	LA	3	7
Medium Laser	LT	1	1
Medium Laser	LT	1	1
Gauss Rifle	RA	7	15
Ammo (Gauss) 16	RT	2	2
Medium Laser	RT	1	1
Medium Laser	RT	1	1
Jump Jets	LL	2	2
Jump Jets	RL	2	2
Jump Jet	CT	1	1

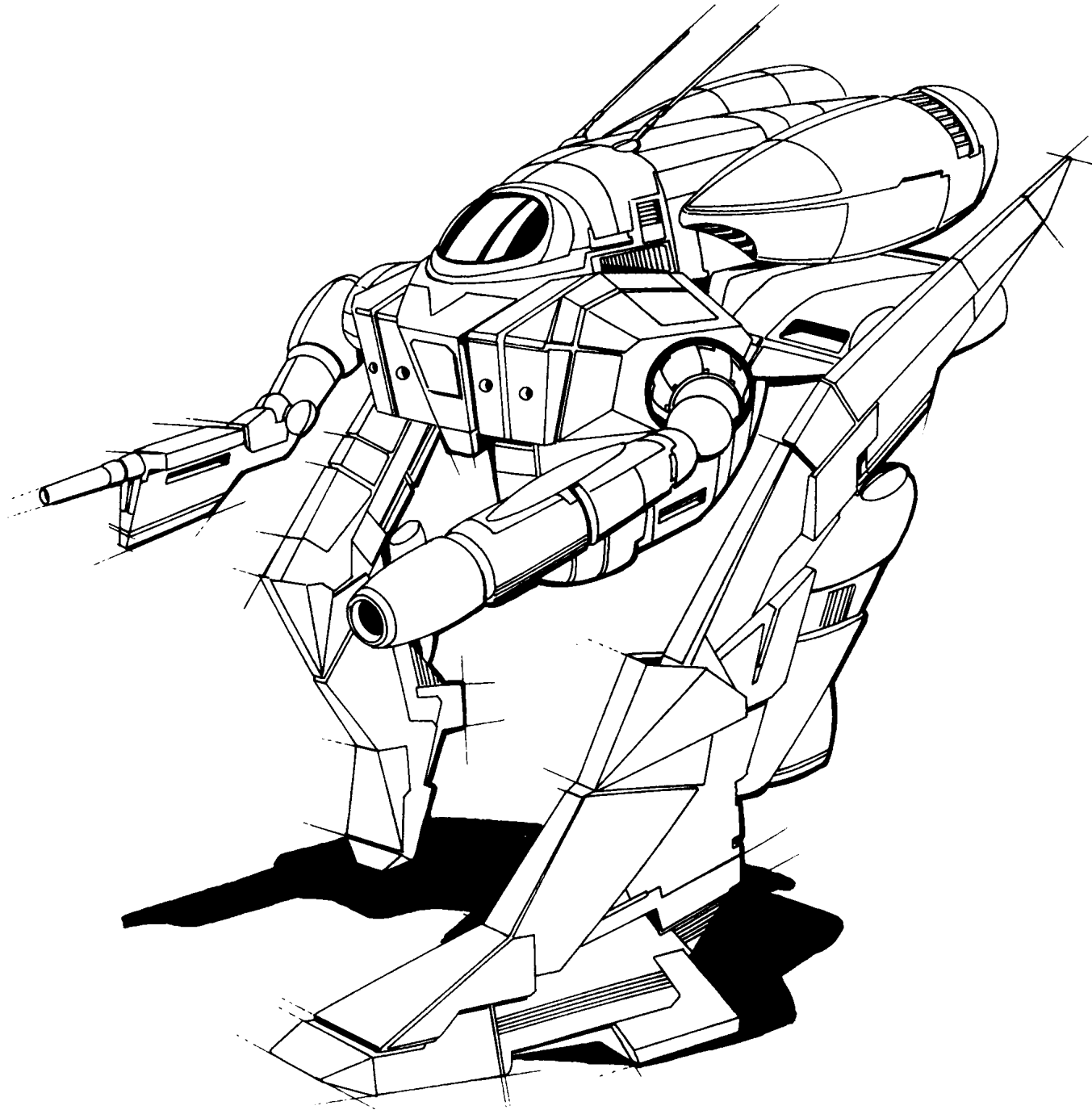

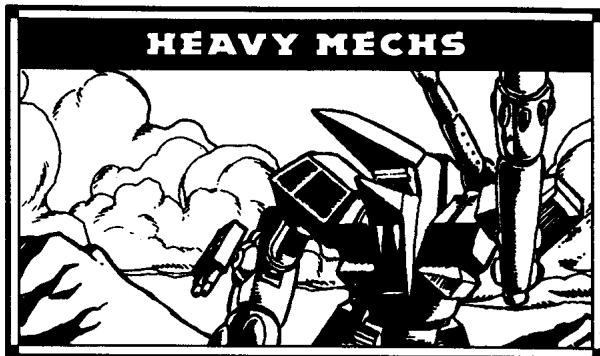

Mass: 75 tons
Chassis: Crucis G
Power Plant: Vlar 300
Cruising Speed: 43 kph
Maximum Speed: 65 kph
Jump Jets: Anderson 398
Jump Capacity: 120 meters
Armor: Durallex Heavy
Armament:
 2 Diverse Optics Sunbeam
 Extended Range Large Lasers
 6 Sutel Precision Line Medium Pulse Lasers
 1 Yori Flyswatter Anti-Missile System
Manufacturer: Kallon Industries
Primary Factory: Talon
Communications System: Dalban Micronics
Targeting and Tracking System: Matabushi Sentinel

Overview:
 One of the most feared Clan 'Mechs that the Federated Commonwealth faced during the invasion was the *Nova*, or *Black Hawk*, a machine devastating in combat on all fronts. Kallon Industries, of Talon, proposed the *Penetrator* based on their review and subsequent analysis of battle footage. The *Penetrator* uses much of the *Nova* design in its concept, especially the primary configuration.

Capabilities:
 The *Penetrator* is a heavy 'Mech designed to be the equal of a Clan 'Mech in sheer short-range fire-

power. It mounts six Sutel Precision Line medium pulse lasers for this purpose. Two Diverse Optics ER large lasers were added for a respectable long-range punch and for defense, and an anti-missile system was installed in the center torso. The 'Mech runs at a maximum of 65 kph and can jump up to 120 meters. These speeds allow the *Penetrator* to keep pace with other heavy 'Mech designs.

Deployment:
 The *Penetrator* was considered a gamble by some military experts in the Federated Commonwealth. Despite the hope that the *Penetrator* would match the *Nova* in one-on-one combat, it is not likely that a 'Mech of its size can surpass the superior technology of the Clan 'Mech. Therefore, the *Penetrator* was put through the most rigorous and extensive testing possible. Virtually all likely battle situations were simulated, and the *Penetrator* scored as expected in all.

The Kallon Industries conglomerate has agreed to keep the Federated Commonwealth as the exclusive customer for the 75-ton behemoth. Kallon has been given the rights to produce the initial order and two additional guaranteed runs in the near future. The first *Penetrator* was shipped in July 3053. Since that time, the remainder of the initial run has been produced and dispersed among various companies in the Federated Commonwealth military.

Variants:
 The dependence on energy weapons forced the installation of numerous heat sinks on the *Penetrator*. To eliminate some of these, it has been suggested replacing the beam weapons with cooler ballistic or missile weapons. Both types of lasers cannot be used together because of heat build-up, so another possibility is to add more heat sinks at the expense of some armor or a medium pulse laser or two. Armor can also be removed in order to add a defensive system, such as a Guardian ECM suite or a Beagle active probe, but this particular retrofit is tricky and not recommended for implementation in the field.

Type: Penetrator
Technology Base: Inner Sphere
Tonnage: 75

Equipment		Mass
Internal Structure:		7.5
Engine:	300	19
Walking MP:	4	
Running MP:	6	
Jumping MP:	4	
Heat Sinks:	12 [24]	2
Gyro:		3
Cockpit:		3
Armor Factor:	208	13
	<i>Internal Structure</i>	<i>Armor Value</i>
Head	3	9
Center Torso	23	34
Center Torso (rear)		9
R/L Torso	16	24
R/L Torso (rear)		7
R/L Arm	12	21
R/L Leg	16	26

Weapons and Ammo	Location	Critical	Tonnage
ER Large Laser	LA	2	5
ER Large Laser	RA	2	5
Medium Pulse Laser	LT	1	2
Medium Pulse Laser	LT	1	2
Medium Pulse Laser	LT	1	2
Medium Pulse Laser	RT	1	2
Medium Pulse Laser	RT	1	2
Medium Pulse Laser	RT	1	2
Anti-Missile System	CT	1	.5
Ammo (Anti-Missile) 12	CT	1	1
Jump Jets	LL	2	2
Jump Jets	RL	2	2

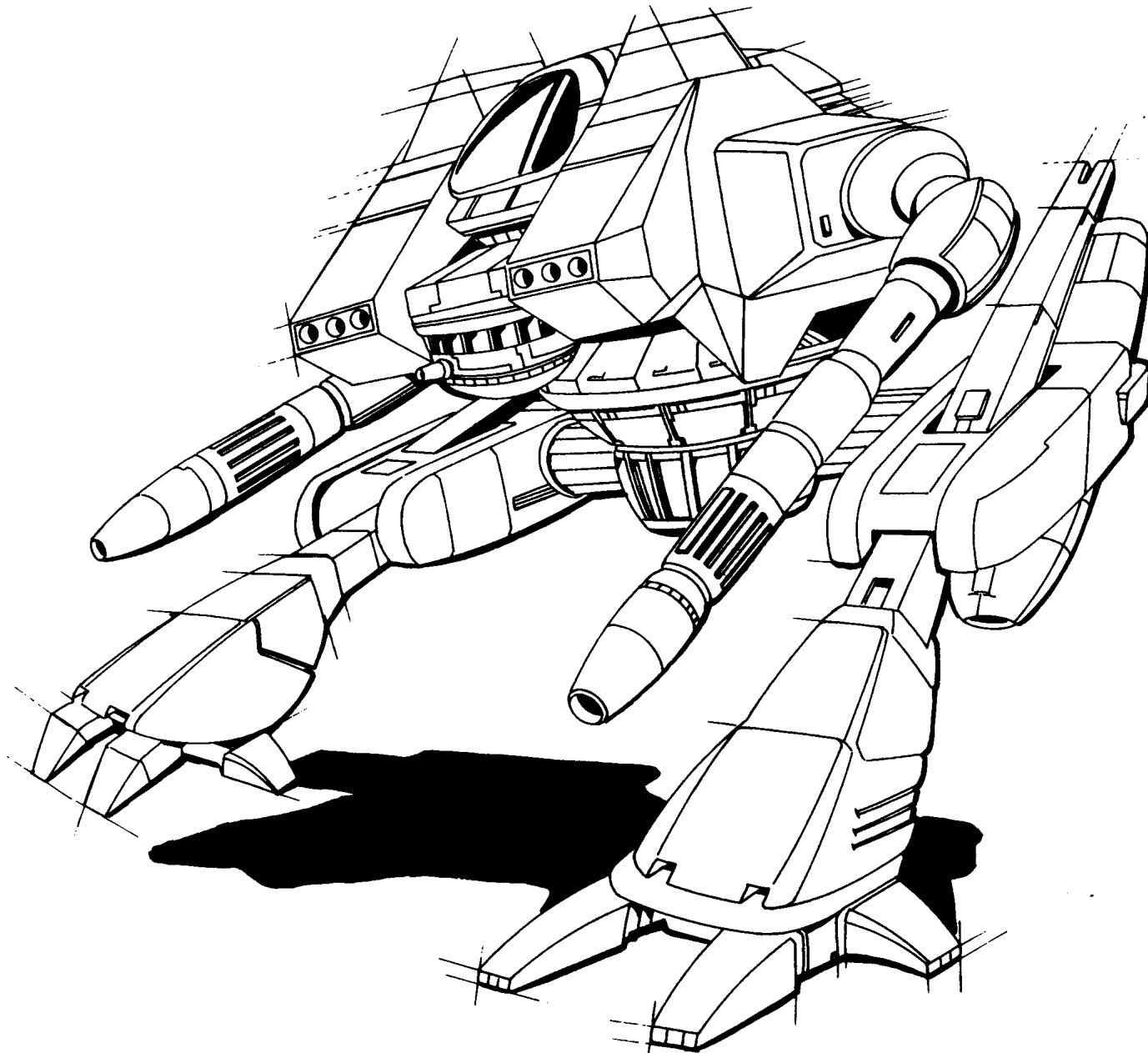

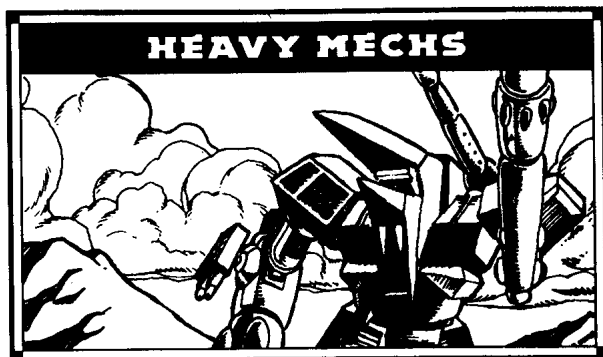

Mass: 75 tons

Chassis: GM Marauder Special MD

Power Plant: GM 375 XL

Cruising Speed: 54 kph

Maximum Speed: 86.4 kph

Jump Jets: None

Jump Capacity: None

Armor: StarGuard Ferro-Fibrous

Armament:

2 Federated LRM-10 Racks

2 ExoStar Extended Range Large Lasers

2 Martell Medium Lasers

1 Martell Medium Pulse Laser

Manufacturer: General Motors

Primary Factory: Kathil

Communications System: Dalban Micronics

Targeting and Tracking System: Sync Tracker
(39-42071) with Artemis IV System

Overview:

Since the Inner Sphere's first look at an OmniMech on The Rock in 3049, 'Mech designers have marveled at the design excellence of the so-called *Mad Cat*. Few could believe that the firepower of a *Marauder* and a *Catapult* could be combined on one chassis, and still move at a 33 percent higher speed. NAIS technicians and students have been laboring for more than five years to emulate the *Mad Cat's* design profile. A recent breakthrough has produced a masterpiece of design, the *Rakshasa*, so named for the mythical creature that mimicked its adversaries' appearance and skills.

Capabilities:

Whether because of, or in spite of, the tight security around the *Rakshasa* project, rumors abound that the "breakthrough" that led to the final design came from analysis of a captured Clan *Mad Cat*. No matter what the truth, the *Rakshasa* is an amazing product of years of development. Built on a heavily modified GM *Marauder* chassis, the 'Mech uses endo steel technology to strengthen and lighten the skeleton.

After long debate, the designers chose to focus on firepower rather than safety. They eliminated the plans for CASE to make room for Artemis IV fire-control processors. These sensors provide the two Federated 10-shot missile LRM-10 racks with unmatched accuracy and tight shot grouping. It is hoped that this accuracy will make up for the smaller launchers, since Clan LRM racks are considerably lighter.

The *Rakshasa's* "bite" comes from two arm-mounted ExoStar ER large lasers, each of which is supplemented by a Martell medium laser for additional short-range firepower. The muzzles of these weapons are recessed into the 'Mech's forearms, allowing the pilot to engage in hand-to-hand combat without damaging the laser's optics and emitters. A single Martell medium pulse laser rounds out the *Rakshasa's* armaments, making it a virtual double of its parent design.

Field testing and simulation show that while the *Rakshasa's* mission profile matches that of the *Mad Cat*, its weapon range and firepower are clearly inferior to the Clan design. Despite this shortcoming, the *Rakshasa* remains a formidable heavy 'Mech, with superior accuracy, speed, and maneuverability.

Deployment:

General Motors has just begun full production of the *Rakshasa*, expecting to send four out by the end of the year, and six each year thereafter. Initial shipments are designated to the Tenth Lyran Guards RCT at Ft. Loudon. Because this unit is not only in an extremely important tactical location, but also commanded by Victor Steiner-Davion himself, the *Rakshasa* should get quite a workout once it arrives.

Variants:

One of the few drawbacks of this otherwise excellent design is that the paired ER lasers generate excessive heat. The problem can be corrected by replacement with standard large lasers, a variation suggested as a relatively simple field upgrade.

Type: **Rakshasa**

Technology Base: Inner Sphere

Tonnage: 75

Equipment		Mass
Internal Structure:	Endo Steel	4
Engine:	375 XL	19.5
Walking MP:	5	
Running MP:	8	
Jumping MP:	0	
Heat Sinks:	15 [30]	5
Gyro:		4
Cockpit:		3
Armor Factor:	206	11.5
	<i>Internal Structure</i>	<i>Armor Value</i>
Head	3	9
Center Torso	23	32
Center Torso (rear)		9
R/L Torso	16	22
R/L Torso (rear)		7
R/L Arm	12	21
R/L Leg	16	28
Weapons and Ammo	Location	Critical Tonnage
LRM 10	RT	2 5
Artemis IV FCS	RT	1 1
Ammo (LRM) 12	RT	1 1
LRM 10	LT	2 5
Artemis IV FCS	LT	1 1
Ammo (LRM) 12	LT	1 1
ER Large Laser	RA	2 5
ER Large Laser	LA	2 5
Medium Laser	RA	1 1
Medium Laser	LA	1 1
Medium Pulse Laser	LT	1 2

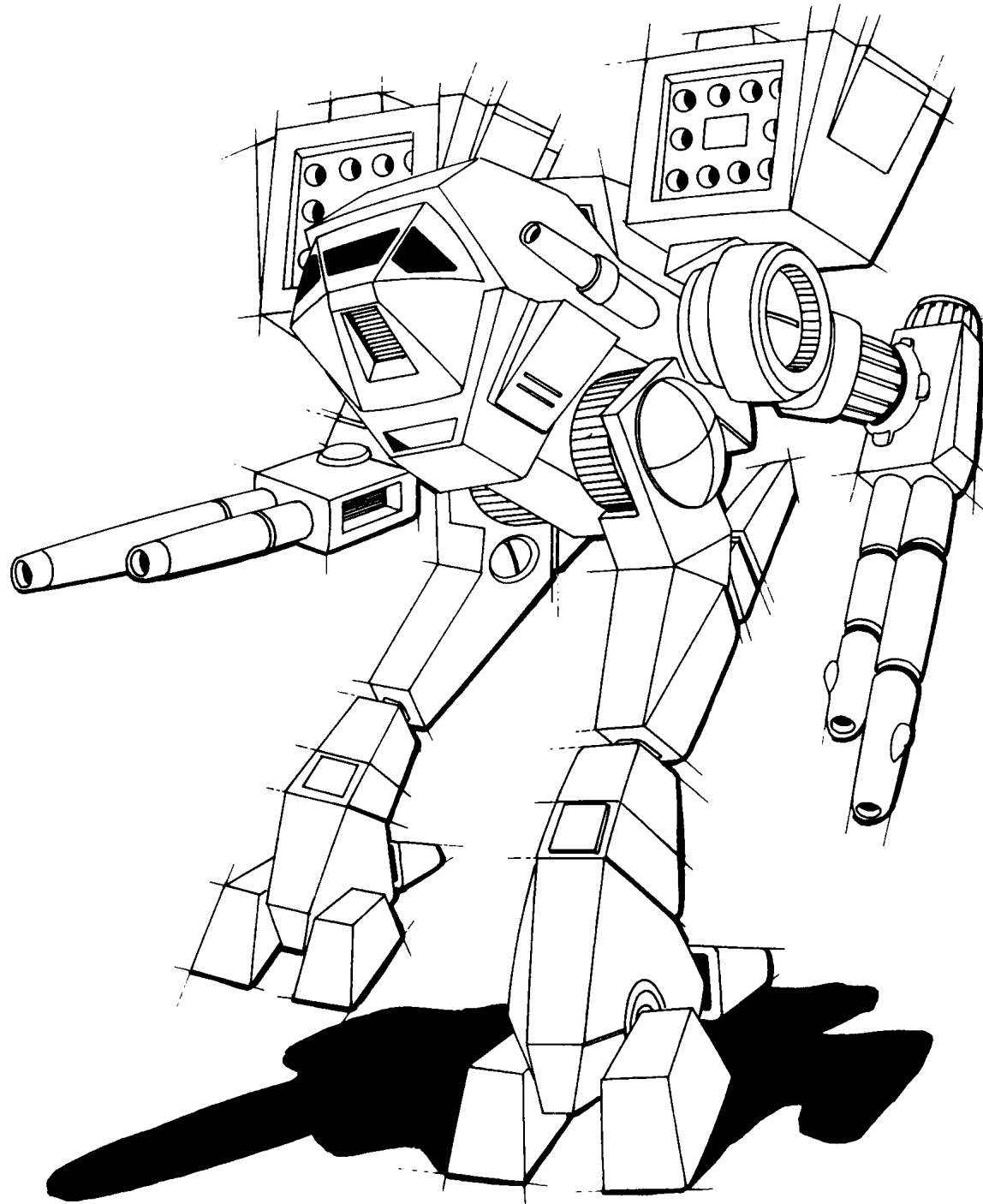

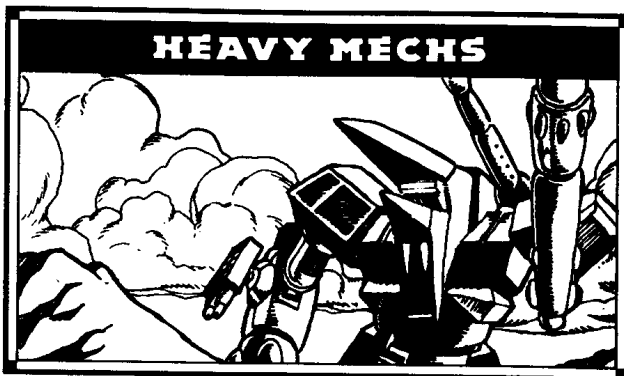

Mass: 75 tons
Chassis: Arc Royal KH/9
Power Plant: Vlar 300 XL
Cruising Speed: 43.2 kph
Maximum Speed: 64.8 kph
Jump Jets: None
Jump Capacity: None
Armor: StarSlab 511 Ferro-Fibrous
Armament:
 1 Grizzard Gauss Rifle
 2 Holly Streak SRM-2 One-Shot Racks
 1 Blankenburg Large Pulse Laser
 2 Martell Medium Pulse Lasers
 1 Martell Small Pulse Laser
 1 Burow Anti-Missile System
Manufacturer: Blackwell Corporation
Primary Factory: Outreach
Communications System: Garret T12-A,
 Garret/Guardian Interface Model 2B
Targeting and Tracking System: Garret O2j

Overview:

The *War Dog* BattleMech has been almost 300 years in the making. Originally designed for use by the SLDF, the plans and prototype chassis were removed from Terra shortly before the fall of the Star League. Only scant references to the design remained until 3052, when Snord's Irregulars, the Federated Commonwealth mercenary unit, captured a long-lost SLDF base in the Dark Nebula.

The base, known as Camelot Command, has been undergoing refurbishing and refitting, serving as a FedCom raiding base despite several attacks by Clan Jade Falcon. During the refit, Snord's Irregulars recovered several chassis for the *War Dog*, as well as a complete set of blueprints. These were smuggled back to the Federated Commonwealth during a resupply run, resulting in an almost immediate start on production.

The Irregular's commanding officer Rhonda Snord had the designs delivered to the Blackwell Corporation, the Wolf's Dragoon-sponsored firm on Outreach. The engineers at Blackwell realized the value of the design and began work on an extended production run of the *War Dog*.

Capabilities:

The key to the success of this heavy 'Mech is its heavy armor protection. With more than twelve tons of ferro-fibrous armor, the *War Dog* can weather the heavy firepower typical of an encounter with Clan forces. Added to this is the anti-missile system mounted on the forward right torso.

The firepower of the 'Mech is based on the Grizzard Gauss rifle, and supplemented by a Blankenburg large pulse laser. The *War Dog* also carries two medium pulse lasers for close-fire support. A small pulse laser is rear-mounted on the head of this 'Mech for anti-Elemental support, the only modification to the original Star League design specifications. The *War Dog* carries a last-ditch weapons system in the two SRM Streak one-shot missile racks mounted on the upper legs of the 'Mech.

One of the most distinctive features of this 'Mech is that its right arm has more armor protection than its left. This imbalance requires that a 'Mech pilot practice some gyro-balancing, but it also offers exceptional protection to the *War Dog's* Gauss rifle, the most powerful weapon it mounts. Though the weapon arm is more heavily shielded, it appears roughly the same size and shape as its weaker companion.

Deployment:

Several *War Dogs*, menacing and easily recognizable, have already found their way to Solaris VII, where the 'Mech has become almost a household name among game fans.

The Blackwell Corporation has filled orders for *War Dogs* with every major Great House of the Inner Sphere and for a number of mercenary units. The Federated Commonwealth currently fields the largest number of *War Dogs*, with most assigned to the Federated Commonwealth/Clan Occupation Zone border.

The Word of Blake has placed an order for two lances of *War Dogs*. It is believed that these will serve as replacements in their massive reconstruction and rearming effort.

Type: War Dog
Technology Base: Inner Sphere
Tonnage: 75

Equipment		Mass
Internal Structure:		7.5
Engine:	300 XL	9.5
Walking MP:	4	
Running MP:	6	
Jumping MP:	0	
Heat Sinks:	10 [20]	0
Gyro:		3
Cockpit:		3
Armor Factor:	215	12
	<i>Internal Structure</i>	<i>Armor Value</i>
Head	3	9
Center Torso	23	36
Center Torso (rear)		10
R/L Torso	16	23
R/L Torso (rear)		9
R/L Arm	12	24/16*
R/L Leg	16	28

*Right Arm has 24 Points, Left Arm has 16

Weapons and Ammo	Location	Critical	Tonnage
Gauss Rifle	RA	7	15
Ammo (Gauss) 16	RT	2	2
Ammo (Gauss) 24	LT	3	3
Streak SRM 2 (OS)	RL	1	2
Streak SRM 2 (OS)	LL	1	2
Large Pulse Laser	LA	2	7
Guardian ECM Suite	CT	2	1.5
Medium Pulse Laser	LT	1	2
Medium Pulse Laser	RA	1	2
Small Pulse Laser	H (R)	1	1
Anti-Missile System	RT	1	.5
Ammo (Anti-Missile) 24	RT	2	2

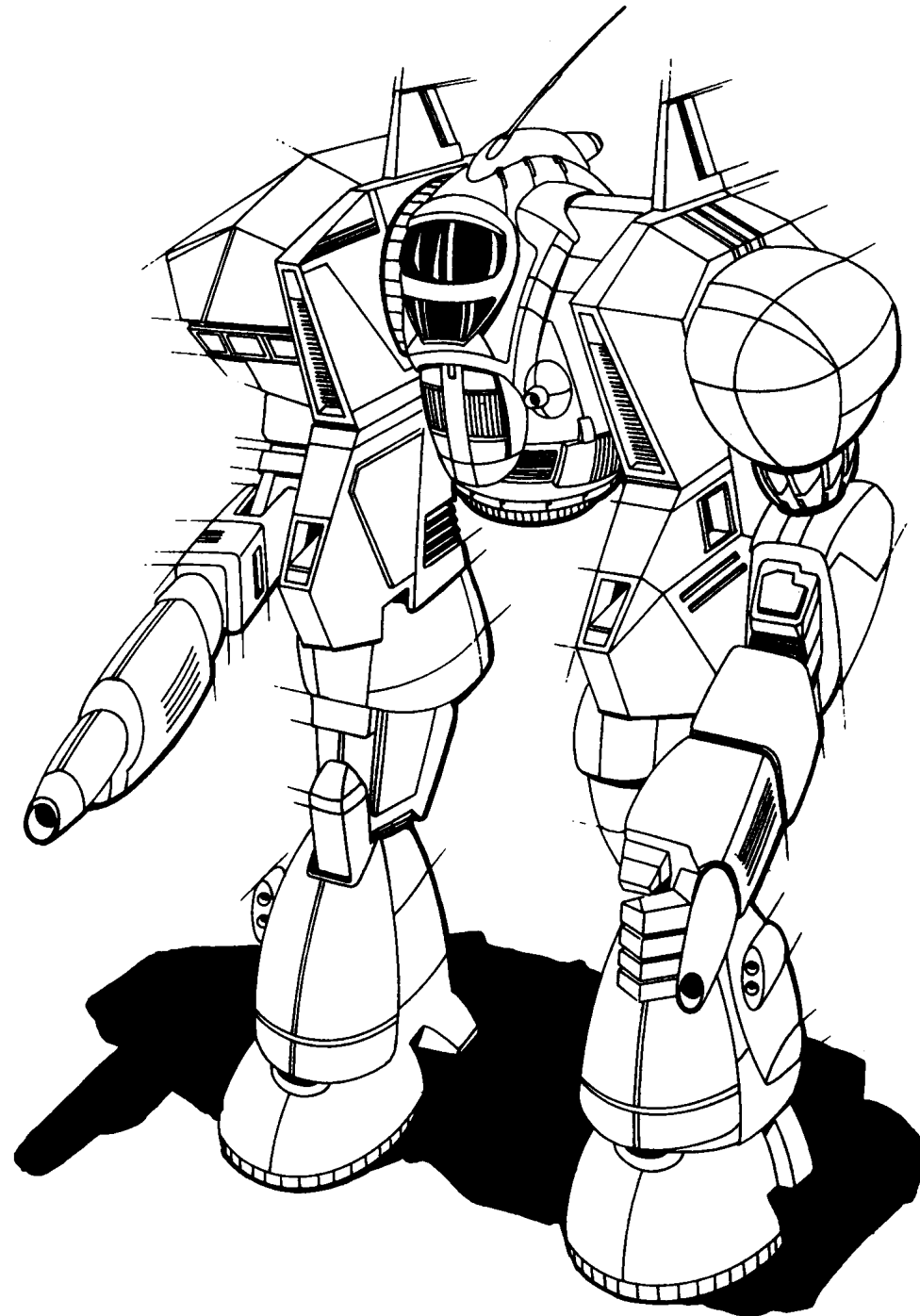

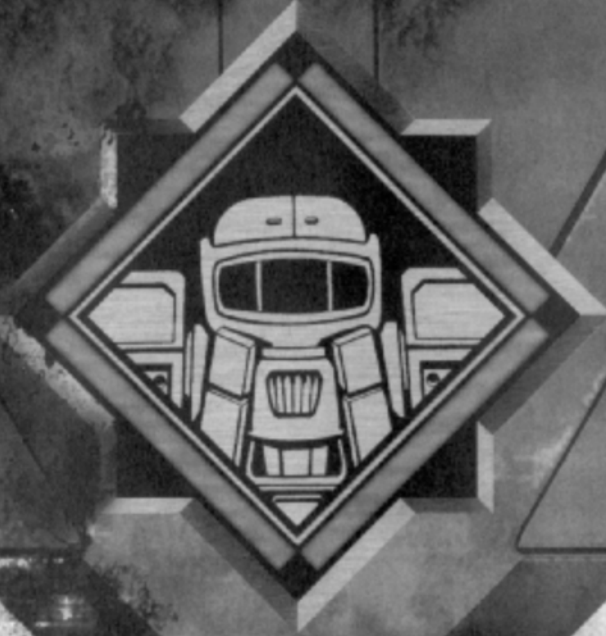

ASSAULT 'MECHS

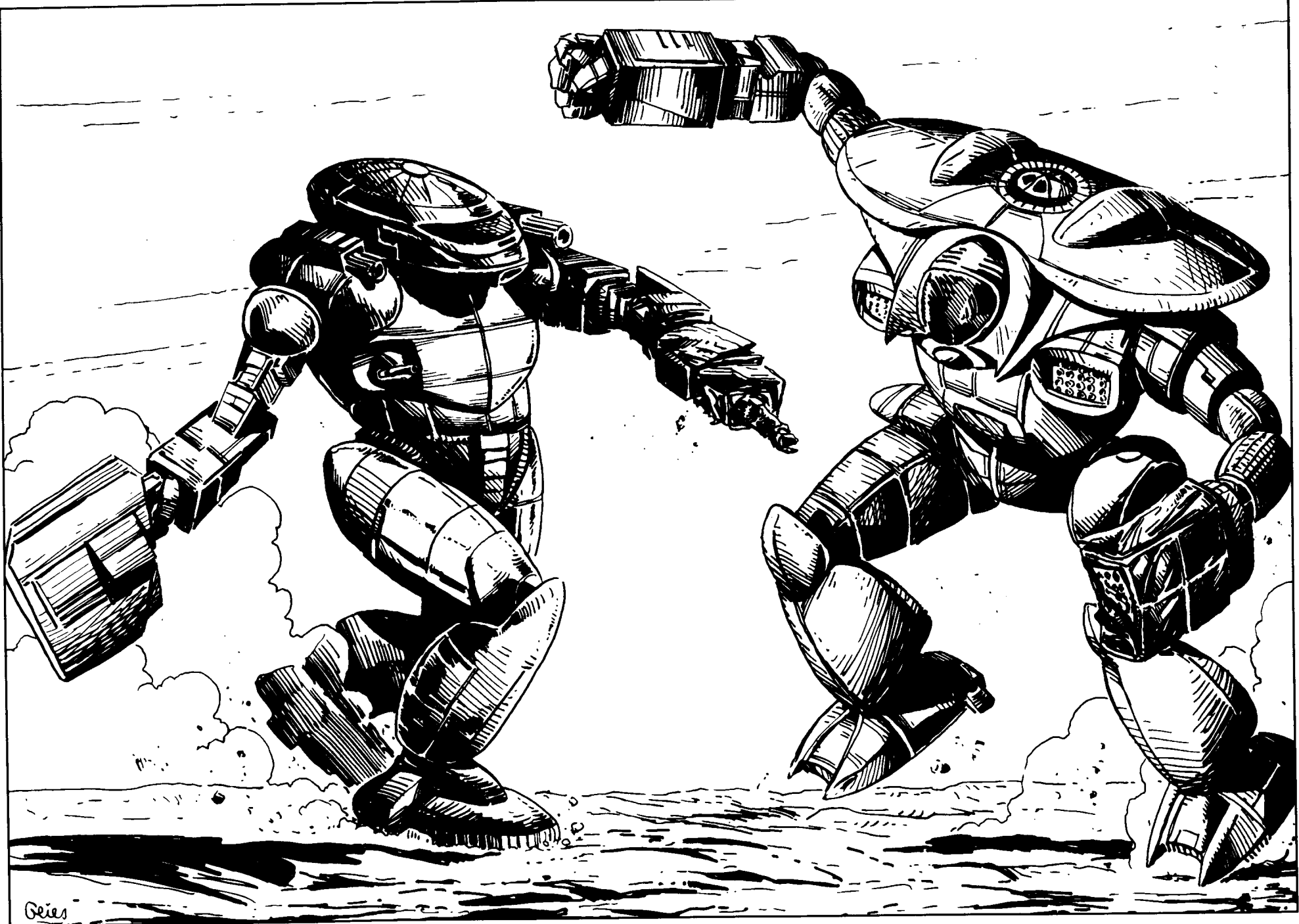

Bees

PPR-5S SALAMANDER

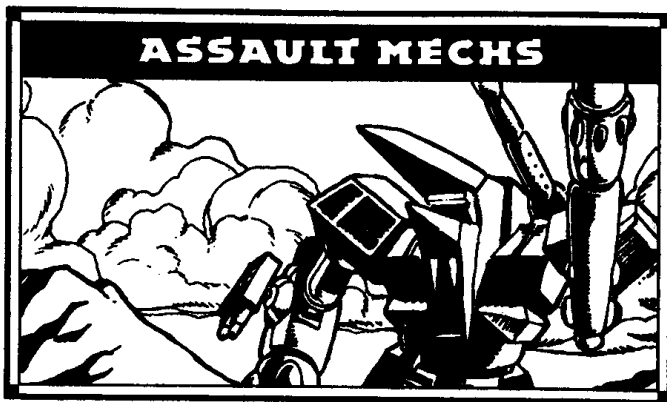

Mass: 80 tons
Chassis: Chariot Type IV with Endo Steel
Power Plant: Pitban 320 XL
Cruising Speed: 43 kph
Maximum Speed: 65 kph
Jump Jets: None
Jump Capacity: None
Armor: Glasgow Limited with CASE
Armament:
 3 Doombud LRM-20 Racks
 2 Defiance B3M Medium Lasers
Manufacturer: Defiance Industries
Primary Factory: Hesperus II
Communications System: TharHes Hm-10
Targeting and Tracking System: TharHes Ares-7

Overview:

"Radical designs for radical times" is the slogan that hangs on the wall of the PPR-5S *Salamander* production line at the Defiance Industries plant on Hesperus II. By removing the appropriate actuators in the 'Mech's left arm, a third LRM-20 rack was installed, giving the machine a strange, bulging appearance.

Capabilities:

The *Salamander* weighs 80 tons and is as fast as most 'Mechs in its class. The 'Mech can achieve a maximum speed of 65 kph but cannot jump. Because of its role in a combat setting, however, movement is actually a secondary concern.

The radical design of the torso houses two of the three LRM-20 racks that promise to wreak utter devastation upon an enemy. Each launcher has three tons of ammunition for a total of 18 volleys.

Deployment:

Presently, only nine *Salamander* assault 'Mechs have been produced by Defiance Industries. The remaining 'Mechs in the initial order will be finished within six months. The production of the oddly shaped machine is somewhat slower than normal, primarily because of the unusual arm infrastructure.

The nine produced so far have been assigned predominantly in areas near the Jade Falcon Occupation Zone border with the Federated Commonwealth. This is apparently a precaution, in case of future hostilities in these areas.

Variants:

Needless to say, several variants to this radical 'Mech design have been suggested. The most obvious would substitute the left-arm LRM with an SRM rack for close-in fire support. The additional tonnage could be dedicated to heat sinks and additional ammunition for the remaining missile racks. Other ideas include removal of the LRM rack in favor of upgrading the two medium lasers to medium pulse lasers, increasing speed by upgrading the engine, or installing a large pulse laser at the additional cost of the medium lasers. No variants are in the field at this time.

Type: Salamander
 Technology Base: Inner Sphere
 Tonnage: 80

Equipment		Mass
Internal Structure:	Endo Steel	4
Engine:	320 XL	11.5
Walking MP:	4	
Running MP:	6	
Jumping MP:	0	
Heat Sinks:	10 [20]	0
Gyro:		4
Cockpit:		3
Armor Factor:	248	15.5
	<i>Internal Structure</i>	<i>Armor Value</i>
Head	3	9
Center Torso	25	42
Center Torso (rear)		8
R/L Torso	17	28
R/L Torso (rear)		6
R/L Arm	13	26
R/L Leg	17	34

Weapons and Ammo	Location	Critical	Tonnage
LRM 20	LT	5	10
Ammo (LRM) 18	LT	3	3
CASE	LT	1	.5
LRM 20	RT	5	10
Ammo (LRM) 18	RT	3	3
CASE	RT	1	.5
LRM 20	LA	5	10
Ammo (LRM) 18	LA	3	3
Medium Laser	CT	1	1
Medium Laser	CT	1	1

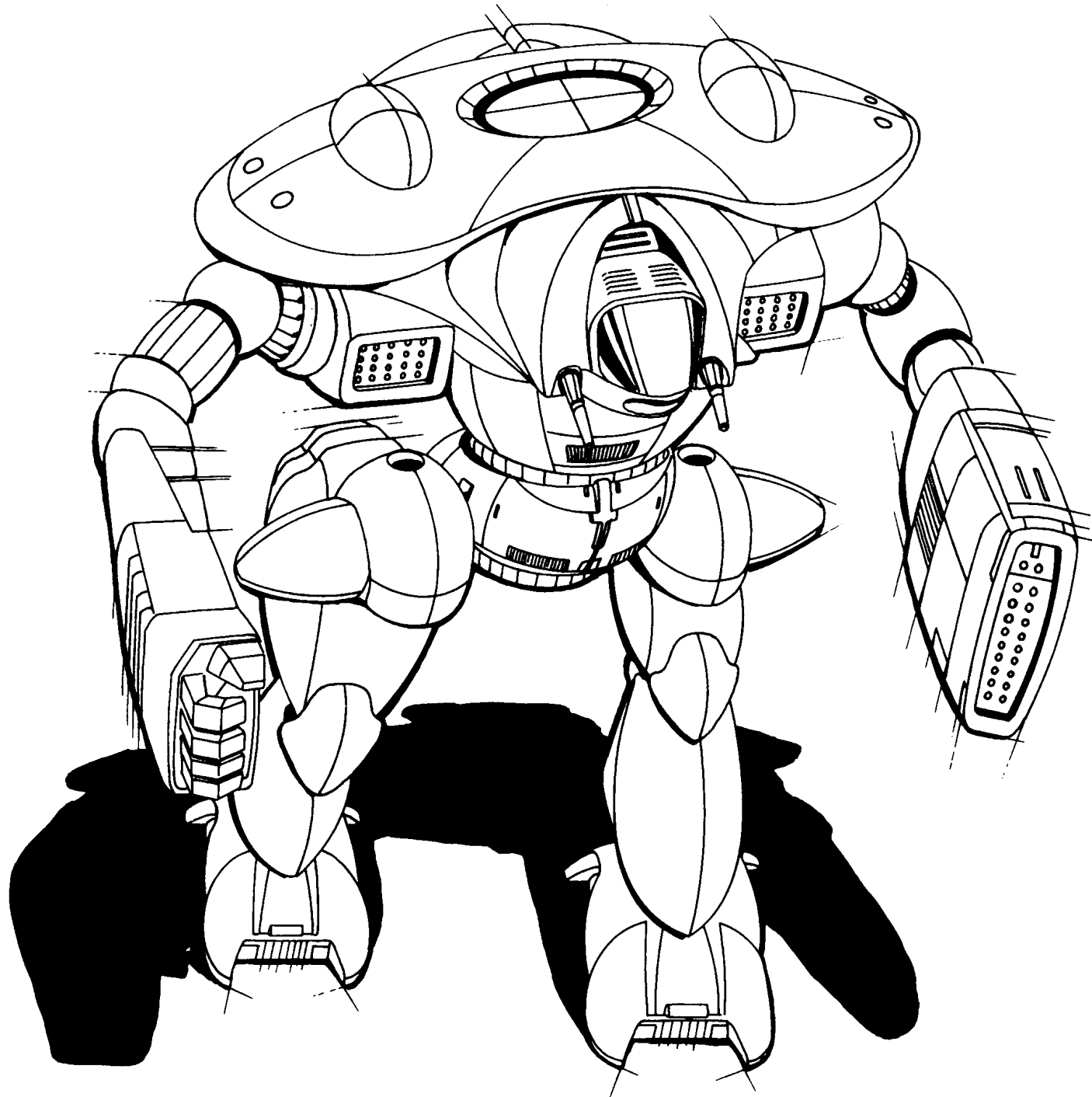

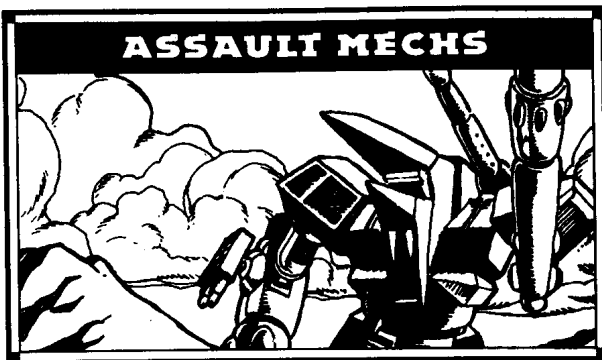

Mass: 85 tons
Chassis: Star League XT
Power Plant: VOX 255 XL
Cruising Speed: 32 kph
Maximum Speed: 54 kph
Jump Jets: HildCo Model 12
Jump Capacity: 60 meters
Armor: Kevlar 5000
Armament:

- 2 Poland Main Model A Gauss Rifles
- 2 Defiance P5M Medium Pulse Lasers
- 4 Defiance B3M Medium Lasers

Manufacturer: Defiance Industries,
 Independence Weaponry
Primary Factory: Hesperus II (Defiance),
 Quentin (Independence)

Communications System: Nashan Quartet
 ComSy with Guardian ECM
Targeting and Tracking System: Nashan Diana
 Mark II Targeting Computer

Overview:

The Clan invasion created some strange bedfellows. The Federated Commonwealth's and Draconis Combine's mutual non-aggression pact and intelligence-sharing quickly evolved into a quasi-union of the two Great Houses. In the same spirit of cooperation, engineering teams from both realms also traveled to help the Free Rasalhague Republic relocate its single 'Mech factory. These teams had already dealt with

each other on previous occasions, creating an amicable working environment.

The *Gunslinger* BattleMech was not something the teams planned to design when talk around the table turned to the Clans and the weapons that would stop them. As an exercise, the two groups tabled their opinions and then justified them. After a few such informal sessions, the engineers realized that they had plenty to say about the weapon of choice. The *Gunslinger* was designed as a mobile assault platform, capable of crippling a Clan 'Mech at the extended ranges at which the Omnis can fight.

Capabilities:

The *Gunslinger's* designers avoided assigning the 'Mech a specific weapons configuration, instead relying on generic attributes of a weapons class to make a more versatile design. This enabled the team to localize much of the electronics, weapon makes, and models, and to reduce the dependence on a particular piece of equipment.

The first consideration was the dual Gauss rifles, the only weapons that could equal ranges and compare favorably in damage to Clan equipment. The Kurita delegation voiced their admiration of the *Katana*, and the 85-ton weight class.

When secondary weapons were discussed, Kurita engineers swore by the old medium lasers that championed efficiency of design. An F-C technician persuaded everyone on the use of medium pulse lasers to protect the rear of the 'Mech, and went so far as to place them in the *Gunslinger's* feet. The weapon spread was akin to a *BattleMaster*, a favorite among all present.

The *Gunslinger's* speed had been consciously set at 32 kph. To improve on terrain-handling, massive jump jets were planned for the legs. The jump distance would be only 60 meters, but it would still let the 'Mech bypass most dangerous terrain features.

For protection, the 'Mech was armored to near maximum. Even with 15.5 tons of armor, this great 'Mech seemed fragile when subjected to combat simulations against Clan units.

The final blueprints were duplicated, and each group received a copy before they returned home. It was a solemn parting, as word had been received of the Clan attack on Luthien. Each team promised to pursue the production of plans as soon as possible.

Deployment:

The first Federated Commonwealth *Gunslinger* walked off the East Wing BattleMech line at Defiance Industries on December 5, 3053. The Draconis Combine had hoped to have the first 'Mech out of the Quentin factory doors by the same time, but difficulties with the twin Gauss rifles have kept the 'Mech from receiving final clearance.

Type: **Gunslinger**
 Technology Base: Inner Sphere
 Tonnage: 85

Equipment		Mass
Internal Structure:		8.5
Engine:	255 XL	6.5
Walking MP:	3	
Running MP:	5	
Jumping MP:	2	
Heat Sinks:	10 [20]	0
Gyro:		3
Cockpit:		3
Armor Factor:	248	15.5
	<i>Internal Structure</i>	<i>Armor Value</i>
Head	3	9
Center Torso	27	34
Center Torso (rear)		19
R/L Torso	18	25
R/L Torso (rear)		11
R/L Arm	14	25
R/L Leg	18	32

Weapons and Ammo	Location	Critical	Tonnage
Beagle Active Probe	CT	2	1.5
Small Laser	H	1	.5
Guardian ECM Suite	RT	2	1.5
Gauss Rifle	RA	7	15
Ammo (Gauss) 24	RT	3	3
Gauss Rifle	LA	7	15
Ammo (Gauss) 16	LT	2	2
Medium Pulse Laser	RL (R)	1	2
Medium Pulse Laser	LL (R)	1	2
Medium Laser	RT	1	1
Medium Laser	RT	1	1
Medium Laser	LT	1	1
Medium Laser	LT	1	1
Jump Jet	RL	1	1
Jump Jet	LL	1	1

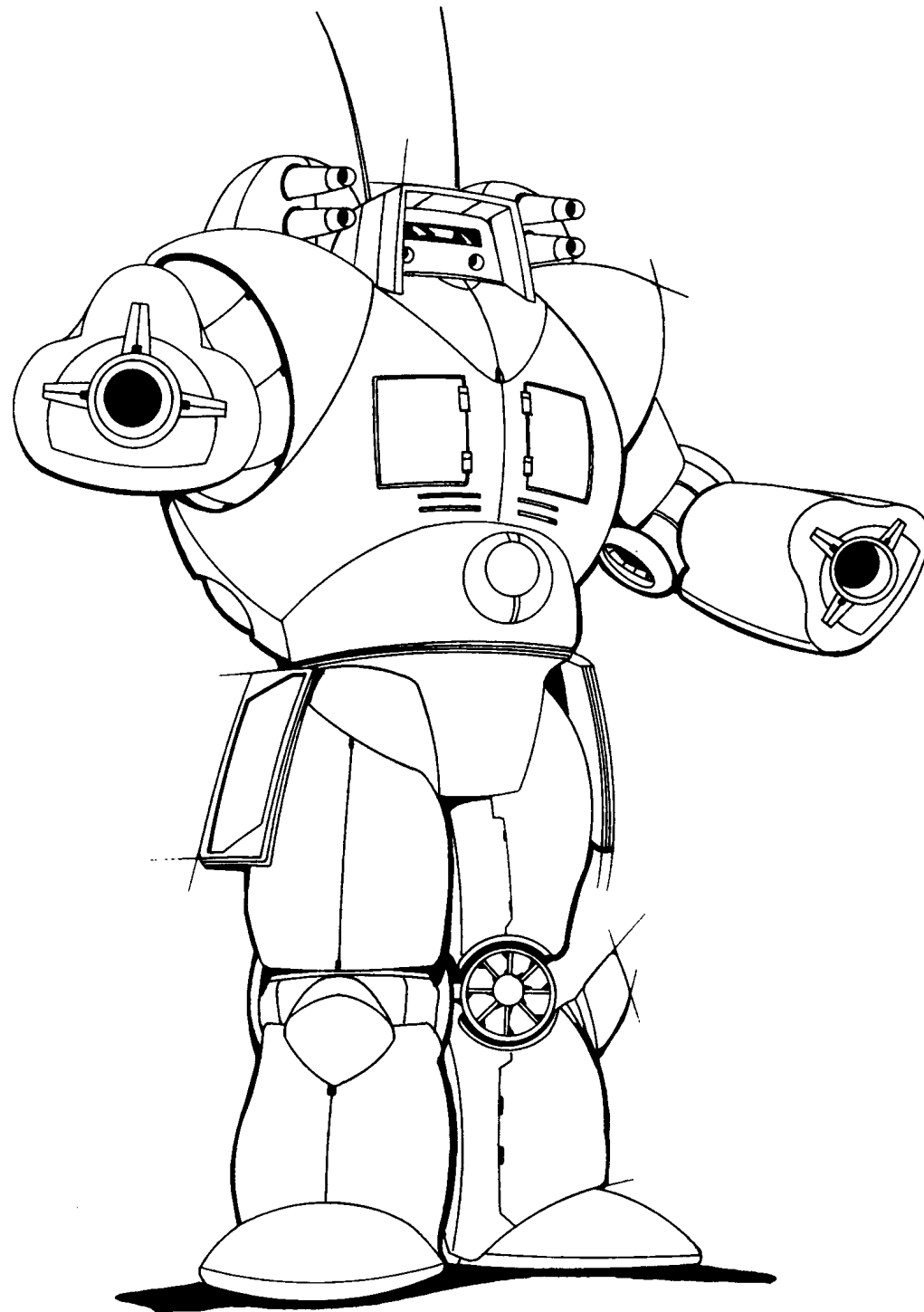

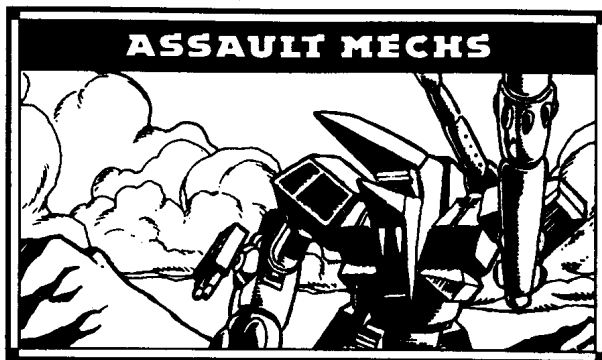

Mass: 95 tons
Chassis: Albat-50
Power Plant: GM 380 XL
Cruising Speed: 43.2 kph
Maximum Speed: 64.8 kph
Jump Jets: None
Jump Capacity: None
Armor: StarSlab/3 with CASE
Armament:
 1 Oriente Model O LB 10-X Autocannon
 1 Diverse Optics Sunbeam Extended Range Large Laser
 1 Irian Weapons Works V7 LRM-15 Rack
 1 Irian Weapons Works 60mm SRM-6 Rack
 1 Tronel PPL-20 Large Pulse Laser
 2 Irian Weapons Works Super 6 Medium Lasers
Manufacturer: Irian BattleMechs Unlimited
Primary Factory: Irian
Communications System: Irian Technologies HMR-35s
Targeting and Tracking System: Omicron TrackerKeeper

Overview:

The Clans' lightning invasion of the Inner Sphere has, if nothing else, given pause to many military experts from all the Great Houses. Many people had believed that humanity had reached the zenith of its destructive capabilities, but the Clans have proven that belief wrong both technologically and militarily.

House Marik has been blessed with the unique opportunity of sitting back and watching its enemies be destroyed by the Clan invaders, while making a profit from that very conflict by providing the other embattled Houses with the necessary equipment to fight the Clans.

League strategists believed that when the Clans were finished with the Federated Commonwealth they would come after House Marik. With this in mind, the League's high command commissioned Project Omega in late 3052. The project's goal was to create an assault 'Mech able to face and defeat Clan OmniMechs. After only five months of designing and testing, the Omega team delivered the first *Albatross*.

Capabilities:

Irian BattleMechs Unlimited received the go-ahead to produce the design while they were busy producing refits for the Federated Commonwealth's troops. Using their clients' catalogued preferences and a scattering of reports about Clan fighting style, the Omega team set out to accomplish its task.

At 95 tons, the *Albatross* is one of the heaviest 'Mechs ever produced by House Marik. Thanks to its GM 380 XL engine, it can reach speeds up to 64 kph. Free Worlds designers believed it was better not to burden the *Albatross* with an endo steel chassis or ferro-fibrous armor so that the 'Mech would have ample space for its weapons complement.

The 'Mech's impressive weaponry is designed to be used at all ranges. The LRM rack and the Diverse Optics Sunbeam ER large laser give the 'Mech tremendous long-range firepower. The Oriente Model O LB 10-X autocannon, the Tronel large pulse laser, and the Irian medium lasers keep enemies busy. If an opponent decides to close with the *Albatross*, then the Irian six-rack of SRMs can be brought to bear.

Thirteen tons of armor ensure that the *Albatross* has a long lifespan on the battlefield. The BattleMech's main problem may lie in excessive heat buildup. With only 14 double-strength heat sinks, the machine is prone to overheating.

Deployment:

The first *Albatross* rolled off the production line in 3053, just ten months after it was commissioned, but so far, none seem to have been assigned to regular units. It may be that Marik is stockpiling new designs for sale to the highest bidder, but rumors also suggest that the *Albatross* is one of several new designs that Marik intends for an elite unit he is creating.

Type: Albatross
Technology Base: Inner Sphere
Tonnage: 95

Equipment		Mass
Internal Structure:		9.5
Engine:	380 XL	20.5
Walking MP:	4	
Running MP:	6	
Jumping MP:	0	
Heat Sinks:	14 [28]	4
Gyro:		4
Cockpit:		3
Armor Factor:	208	13
	<i>Internal Structure</i>	<i>Armor Value</i>
Head	3	9
Center Torso	30	37
Center Torso (rear)		10
R/L Torso	20	24
R/L Torso (rear)		8
R/L Arm	16	21
R/L Leg	20	23

Weapons and Ammo	Location	Critical	Tonnage
LB 10-X AC	LA	6	11
Ammo (LB-X) 20	LT	2	2
CASE	LT	1	.5
ER Large Laser	LT	2	5
LRM 15	RT	3	7
Ammo (LRM) 16	RT	2	2
SRM 6	RT	2	3
Ammo (SRM) 15	RT	1	1
CASE	RT	1	.5
Large Pulse Laser	RA	2	7
Medium Laser	RA	1	1
Medium Laser	RA	1	1

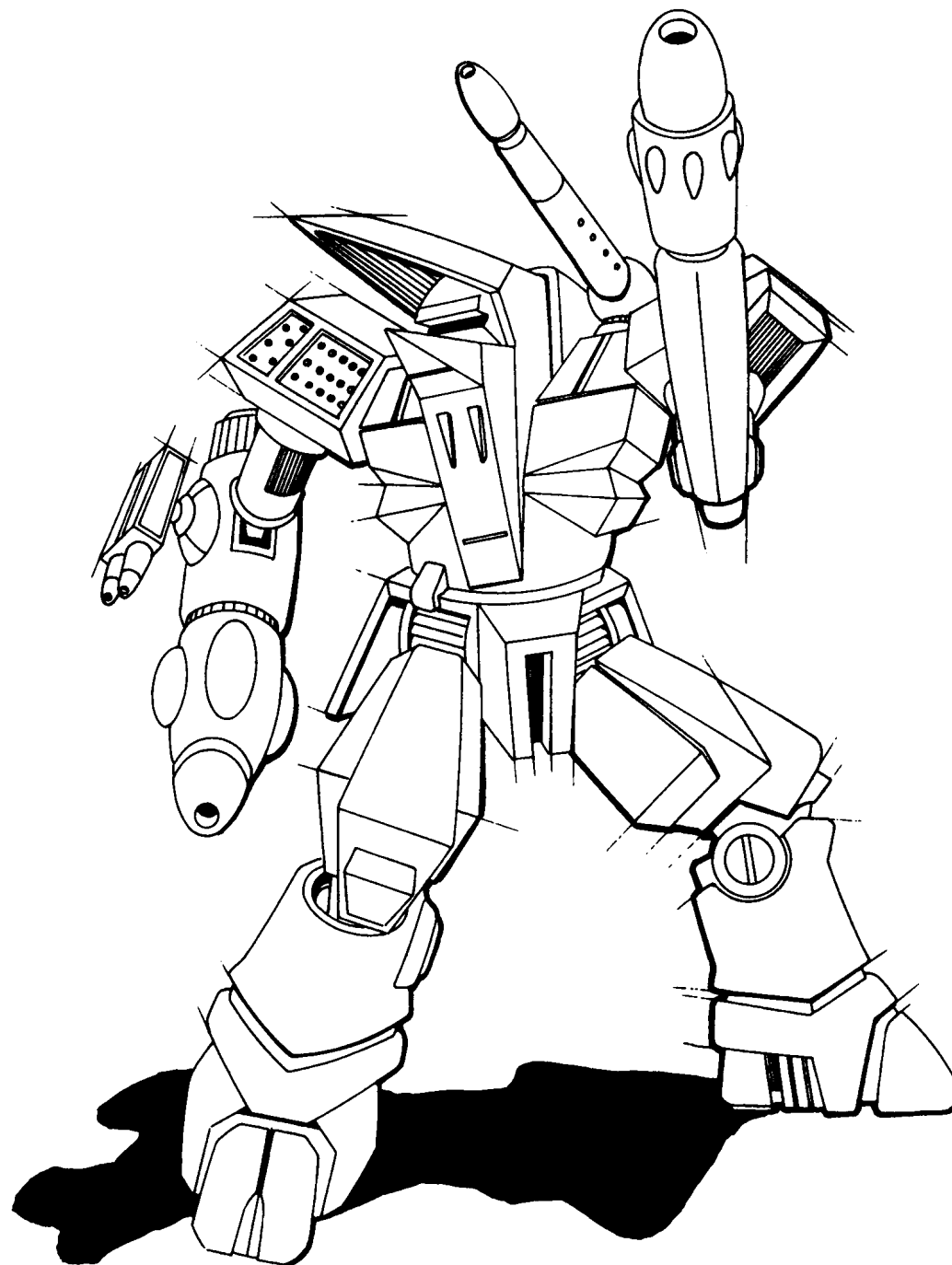

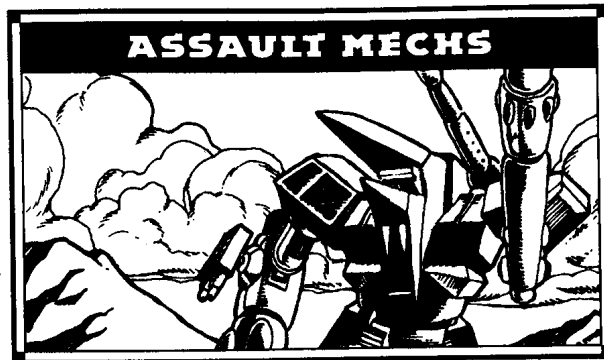

Mass: 95 tons

Chassis: TermoElectron II

Power Plant: GM 380 XL

Cruising Speed: 43.2 kph

Maximum Speed: 64.8

Jump Jets: None

Jump Capacity: None

Armor: Aldis Heavy Ferro-Fibrous

Armament:

2 Grizzard Model 200 Gauss Rifles

4 Blankenburg Medium Pulse Lasers

1 McArthur Anti-Missile System

2 SperryBrowning Machine Guns

Manufacturer: LexaTech Industries

Primary Factory: Hun Ho

Communications System: O/P 3000 OSJ

Targeting and Tracking System: O/P PulseTrack III

Overview:

Similar in shape to the Star League *King Crab*, the *Cerberus* is the product of more than a year's worth of engineering efforts by LexaTech's designers. Flattened thin, its profile makes it difficult to target compared to other assault 'Mechs. The *Cerberus's* legs and lower torso resemble those of a *Vulture*, providing a strong and steady firing platform. Its firepower has made it a formidable opponent against both Clan and Inner Sphere foes.

Capabilities:

Firepower is the key to the success of the *Cerberus* as a front-line BattleMech. For long- and medium-range attacks, it is equipped with two Grizzard Gauss rifles. Though these costly components are in limited supply in the Free Worlds League, they carry a significant wallop in a firefight. With several well-placed long-range shots, a *Cerberus* can all but cripple a Clan or Inner Sphere opponent before taking any significant damage.

Supporting the long-range punch of the Gauss rifles are four medium pulse lasers, which are mounted under fire doors on the upper portion of the 'Mech's torso. During non-combat situations they are invisible. During combat, however, the doors slide away and the lasers extend upward for a better fire angle. During the first engagements against Clan Nova Cat, these weapons were not deployed until the Clan forces were at pointblank range, catching them off guard.

For anti-Elemental operations the *Cerberus* mounts two rear-firing machine guns. With its eleven tons of heavy ferro-fibrous armor and its McArthur anti-missile system, the *Cerberus* is able to sustain itself on the battlefield long enough to inflict significant damage on its opposition.

Deployment:

The first run of *Cerberuses* has already been distributed throughout the Inner Sphere, and more are on the way. This powerful new design will easily become a front-line favorite.

Variants:

Currently the Word of Blake and House Marik both use a version of the *Cerberus* that replaces one of the Gauss rifles with an extended-range PPC. This variant also adds two medium pulse lasers and three tons of additional armor. Known as the MR-5M, the version has become popular with units poised along the Federated Commonwealth border in recent months.

Type: **Cerberus**

Technology Base: Inner Sphere

Tonnage: 95

Equipment

		Mass
Internal Structure:		9.5
Engine:	380 XL	20.5
Walking MP:	4	
Running MP:	6	
Jumping MP:	0	
Heat Sinks:	12 [24]	2
Gyro:		4
Cockpit:		3
Armor Factor:	197	11
	<i>Internal Structure</i>	<i>Armor Factor</i>
Head	3	9
Center Torso	30	35
Center Torso (rear)		15
R/L Torso	20	21
R/L Torso (rear)		10
R/L Arm	16	19
R/L Leg	20	19

Weapons and Ammo	Location	Critical	Tonnage
Gauss Rifle	RA	7	15
Ammo (Gauss) 16	RA	2	2
Gauss Rifle	LA	7	15
Ammo (Gauss) 16	LA	2	2
Medium Pulse Laser	RT	1	2
Medium Pulse Laser	RT	1	2
Medium Pulse Laser	LT	1	2
Medium Pulse Laser	LT	1	2
Anti-Missile System	H	1	.5
Ammo (Anti-Missile) 12	CT	1	1
Machine Gun	LT (R)	1	.5
Machine Gun	RT (R)	1	.5
Ammo (MG) 100	CT	1	.5

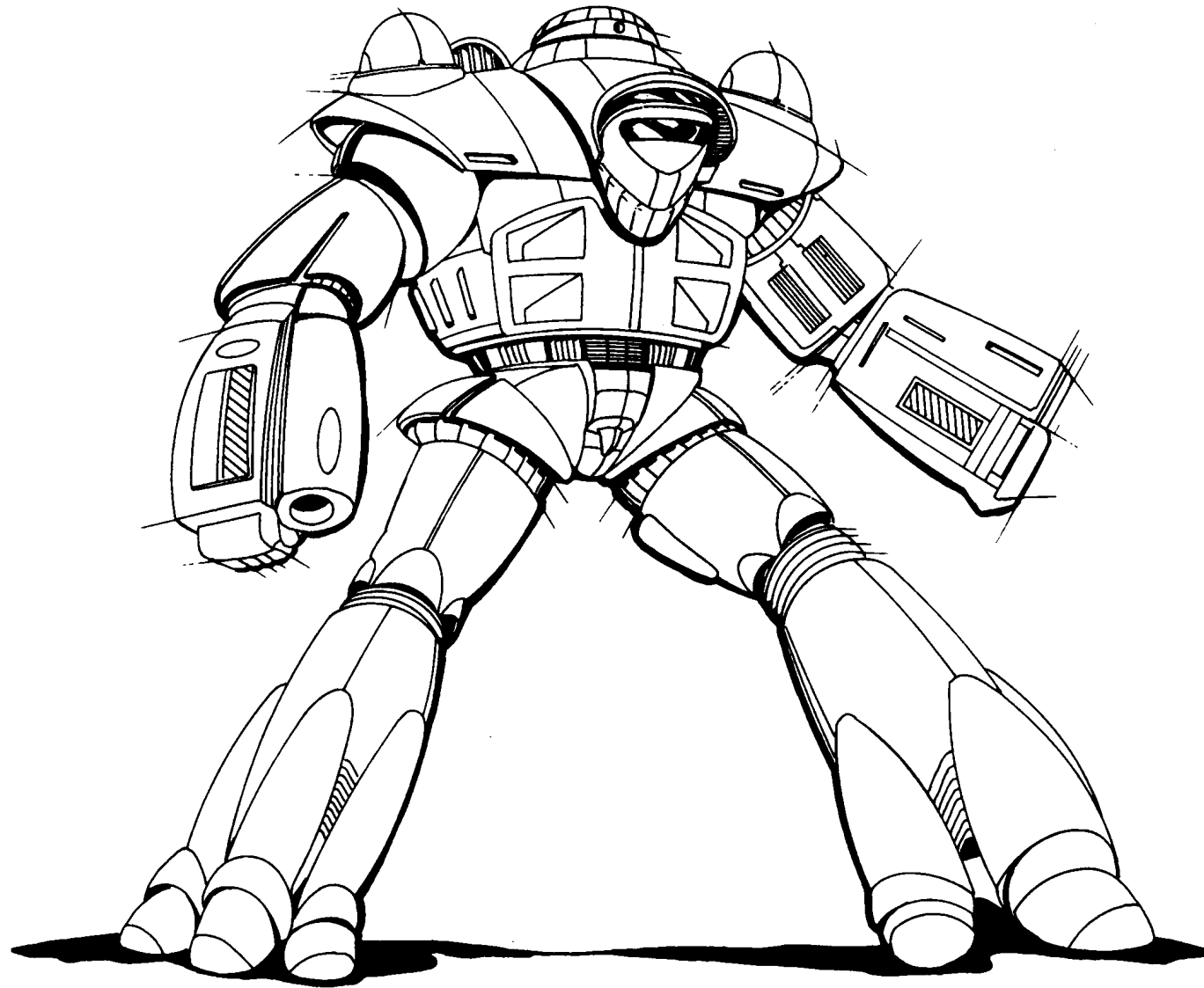

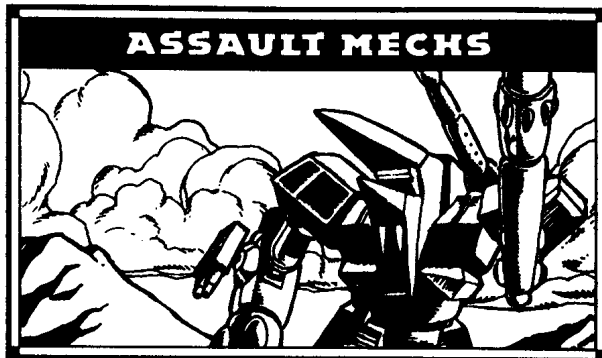

Mass: 95 tons
Chassis: Aishain Class 101a
Power Plant: Pitban 285
Cruising Speed: 32.4 kph
Maximum Speed: 54 kph
Jump Jets: None
Jump Capacity: None
Armor: Durallex Heavy Special with CASE
Armament:
 3 Coventry Star Fire LRM-15 Racks
 1 Lord's Light 2 Extended Range PPC
Manufacturer: Independence Weaponry
Primary Factory: Quentin
Communications System: Garret T19-G with C³ Computer
Targeting and Tracking System: Cat's Eyes 5 with Artemis IV System

Overview:

Draconis Combine 'Mech units have at their disposal a marvel of modern technology that allows unmatched coordination of 'Mechs and lances, increased firing accuracy, and built-in target-acquisition capability. Current intelligence shows that the Clans either do not possess anything like it or else have ceased using it. Amazingly, the Kurita forces rarely use the capability, and when they do, it is often used clumsily or under-utilized because of lack of experience! What could possibly cause the Dragon to ignore such a potential advantage? The answer is as simple as it is surprising: inconvenience.

Capabilities:

The heart of the *Naginata* is the revolutionary command/control/communications (C³) computer system, which has been fully tested and available to the DCMS for nearly five years. What prevents its widespread deployment is the C³'s large size and weight, which make a retrofit lengthy and complicated, requiring the removal of vital weapons, armor, or other needed systems.

Kurita technicians at Independence Weaponry proposed a 'Mech that incorporated the C³ computer as an integral part of the design, eliminating the difficulty of expensive and time-consuming refits. They settled on a 95-ton assault 'Mech for a platform, further defining its role as a command and fire-support unit. The 'Mech was named *Naginata*, after the ancient Japanese pole arm.

The main armament of the *Naginata* consists of three Coventry Star Fire long-range missile racks, with additional accuracy provided by an Artemis IV fire-control system. Long-range missiles were chosen so that the *Naginata* would get the maximum benefit from C³-aided targeting, allowing its lancemates to designate targets for direct and indirect barrages at extended range.

The *Naginata* mounts another long-range weapon, the Lord's Light 2 extended-range PPC, as a reliable backup weapon. The left-arm mounting for the weapon is flanked by two double-strength freezers to help counter the PPC's tremendous heat buildup. This combined assembly is so long and bulky that the left arm has no hand.

Current deployment of the *Naginata* is consistent with its design parameters. It is typically assigned as a command 'Mech for a lance or company. Its three lancemates are medium 'Mechs, or possibly two mediums and a heavy, all retrofit with C³ slave units. They all have greater speed than the *Naginata*, and preferably, jump capability. It is their role to get as close to the enemy as possible, allowing long-range attacks by the *Naginata* and other C³-equipped 'Mechs to come in at greatly increased accuracy.

Until the *Naginata* achieves more widespread deployment, it is still impossible to decide conclusively on its overall effect against Clan forces.

Deployment:

The DCMS has not underestimated the importance of distributing this unit as quickly as possible. Independence Weaponry is expected to send as many as ten of these assault 'Mechs to the Clan front each year. *Naginatas* are currently stationed with the Twelfth Dieron Regulars at Kiesen, the Eleventh Benjamin Regulars at Meilen, and the Seventeenth Galedon Regulars at Chandler. It is a strong possibility that *Naginatas* are also present in many of the so-called "Ghost Regiments" stationed along the Smoke Jaguar front.

Type: *Naginata*
Technology Base: Inner Sphere
Tonnage: 95

Equipment		Mass
Internal Structure:		9.5
Engine:	285	16.5
Walking MP:	3	
Running MP:	5	
Jumping MP:	0	
Heat Sinks:	15 [30]	5
Gyro:		3
Cockpit:		3
Armor Factor:	240	15
	<i>Internal Structure</i>	<i>Armor Value</i>
Head	3	9
Center Torso	30	35
Center Torso (rear)		14
R/L Torso	20	26
R/L Torso (rear)		8
R/L Arm	16	25
R/L Leg	20	32

Weapons and Ammo	Location	Critical	Tonnage
C ³ Computer	LT	5	5
LRM 15	RT	3	7
Ammo (LRM) 32	RT	4	4
Artemis IV FCS	RT	1	1
CASE	RT	1	.5
LRM 15	LT	3	7
Ammo (LRM) 16	LT	2	2
Artemis IV FCS	LT	1	1
CASE	LT	1	.5
ER PPC	LA	3	7
LRM 15	RA	3	7
Artemis IV FCS	RA	1	1

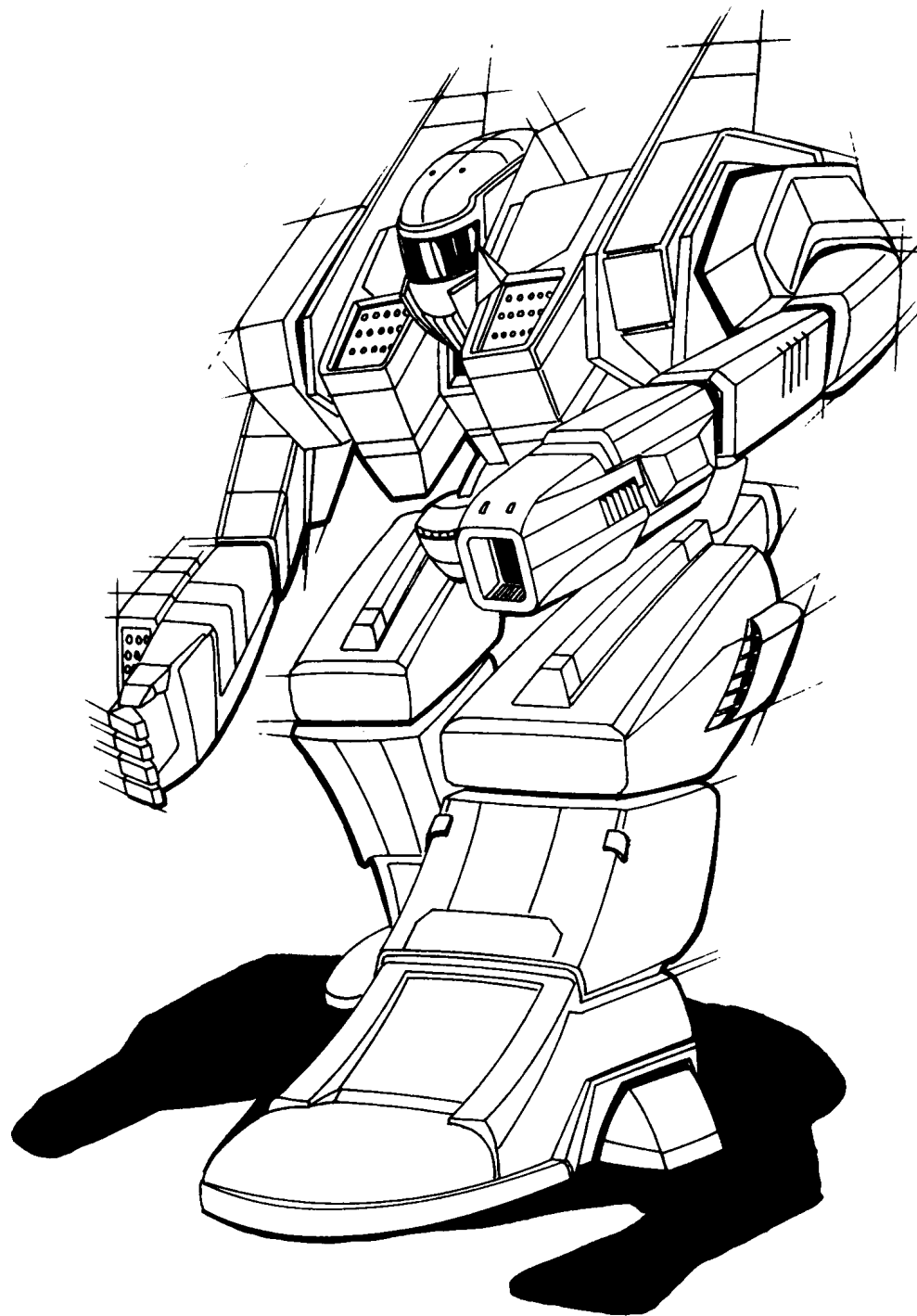

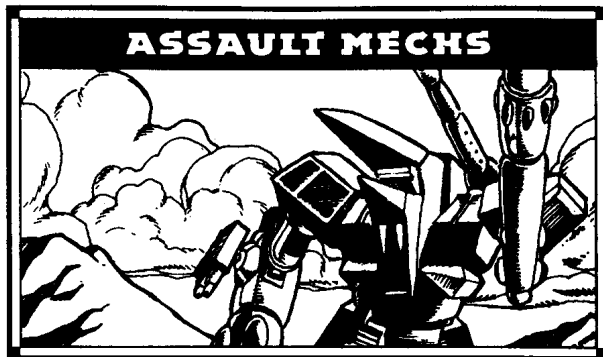

Mass: 100 tons

Chassis: Defiance Berserker

Power Plant: LTV 400 XL

Cruising Speed: 43.2 kph

Maximum Speed: 64.8 kph, w/MASC 86 kph

Jump Jets: None

Jump Capacity: None

Armor: Durallex Special Heavy

Armament:

1 Defiance 1001 Extended Range PPC

1 Zippo Flamer

2 Sutel Precision Line Large Pulse Lasers

1 MainFire Point Defense Anti-Missile System

Manufacturer: Defiance Industries

Primary Factory: Hesperus II

Communications System: Neil 9000 with Guardian Electronic Countermeasures

Targeting and Tracking System: Angst Clear View 2A

Overview:

The BRZ-A3 *Berserker* was created in the tradition of the *Atlas*, a proven and formidable assault 'Mech. The designers at Defiance Industries focused on the appearance of the BattleMech as much as the actual inner workings. Defiance spared no expense to create an awesome state-of-the-art juggernaut. This attitude almost shelved the whole project, due to overspending during research and development.

Capabilities:

The *Berserker's* awesome visage was carefully crafted to create an intimidating monolith that would make the enemy flee in terror. To enhance this effect, designers installed advanced defensive systems, including the Guardian ECM suite and the MainFire Point Defense anti-missile system. This equipment, coupled with superior armor, let the *Berserker* literally wade into the midst of the enemy and do battle.

With this purpose in mind, the *Berserker* is equipped with myomer acceleration signal circuitry (MASC) and a massive LTV 400 XL engine, which permits it to charge at the enemy at a speed of 86 kph. The sight of a hundred-ton, firebreathing, axe-wielding monstrosity should be enough to chase even the most jaded MechWarrior from the field.

For combating foes out of the reach of its hatchet, the *Berserker* is equipped with two Sutel Precision Line large pulse lasers and a Defiance 1001 ER PPC. Firing all three of these weapons simultaneously can cause dangerous heat spikes, so pilots are cautioned to be conservative. When properly applied, these weapons can quickly dispatch distant opponents. In addition, the *Berserker* can operate for extended periods away from supply lines, since its main armament requires no ammunition.

Deployment:

Plagued with small design problems, the *Berserker* is still undergoing testing on Hesperus II. Though it has yet to see actual combat against the Clans, it is perhaps the most thoroughly tested 'Mech in the Inner Sphere. Combat trials against all manner of opposition revealed some weaknesses in the *Berserker's* otherwise impenetrable defenses. Defiance has not revealed the nature of these problems, but they claim to have corrected them.

Variants:

No specific variants have yet been proposed, although there is talk of providing the 'Mech with better long-range firepower. Replacing the pulse lasers with long-range missile launchers is one of the more plausible concepts under consideration.

Type: Berserker

Technology Base: Inner Sphere

Tonnage: 100

Equipment

		Mass
Internal Structure:	Endo Steel	5
Engine:	400 XL	26.5
Walking MP:	4	
Running MP:	6 (8)	
Jumping MP:	0	
Heat Sinks:	16 [32]	6
Gyro:		4
Cockpit:		3
Armor Factor:	296	18.5
	<i>Internal Structure</i>	<i>Armor Value</i>
Head	3	9
Center Torso	31	46
Center Torso (rear)		15
R/L Torso	21	31
R/L Torso (rear)		10
R/L Arm	17	34
R/L Leg	21	38

Weapons and Ammo	Location	Critical	Tonnage
Hatchet	RA	7	7
ER PPC	LA	3	7
Flamer	H	1	1
Large Pulse Laser	RT	2	7
Large Pulse Laser	LT	2	7
Anti-Missile System	CT	1	.5
Ammo (Anti-Missile) 12	CT	1	1
Guardian ECM Suite	RT	2	1.5
MASC	LT	5	5

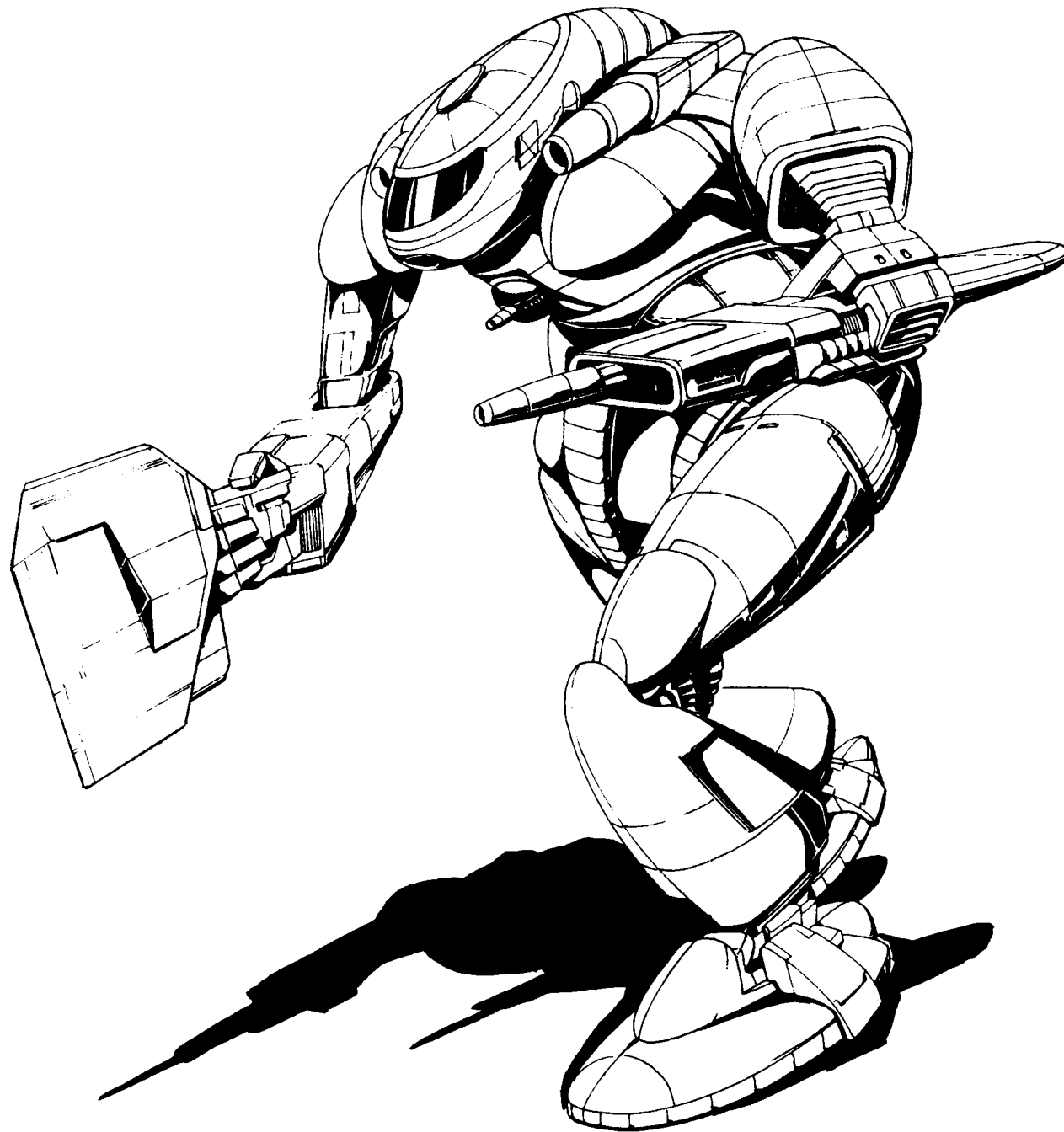

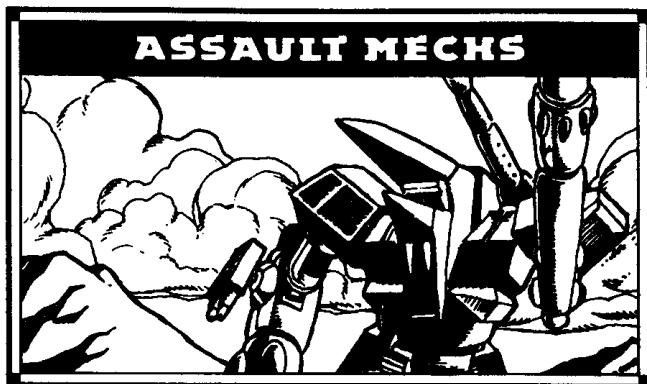

Mass: 100 tons

Chassis: Corean Model 101BLP Endo Steel

Power Plant: LTV 400 XL

Cruising Speed: 43.2 kph

Maximum Speed: 64.8 kph

Jump Jets: None

Jump Capacity: None

Armor: Durallex Heavy

Armament:

2 Diverse Optics Type 20 Large Pulse Lasers

1 Holly LRM-15 Pack

2 Holly SRM-6 Packs

2 Diverse Optics Medium Pulse Lasers

2 Diverse Optics Small Pulse Lasers

1 McArthur Anti-Missile System

Manufacturer: Earthwerks

Primary Factory: Keystone Plant #3

Communications System: Hartford JEA-1

Targeting and Tracking System: O/P FiberFeed 201 with Artemis IV FCS Interface

Overview:

Vining Engineering and Salvage Team (VEST) designed and developed the *Titan* (or *Grand Titan* in the Federated Commonwealth). Building on the success of their *Jackal* design, VEST sought to diversify by creating the *Titan* as their entry to the assault-weight 'Mech class.

Their specifications described an assault 'Mech that could take on the best of both the Inner Sphere and the Clans. During the initial trial runs of the prototype, the *Titan* challenged an *Atlas* as a test of firepower and endurance. The battle lasted ten minutes, and left the *Atlas* a charred hulk. The memorable scene of the *Titan* stomping on the skull-like head of its felled opponent is still used as a sales promotion tool for the *Titan*.

Capabilities:

Assault 'Mechs are not known for speed, but the *Titan* moves fast enough to get into and out of trouble spots and still carries sufficient firepower to damage and/or eliminate the opposition. The key to this remarkable speed is the modified LTV 400 XL fusion reactor. This power plant suffered design problems in the early stages of development, but with those problems now resolved, the LTV 400 XL series has proven very reliable.

The *Titan's* defensive capabilities begin at the core. The 'Mech's skeleton is Corean endo steel. More than 18 tons of Durallex Heavy armor protect the internal mechanisms, enough in most areas to withstand even the deadly firepower of the Clan OmniMechs. The VEST engineers incorporated the McArthur anti-missile system, giving the *Titan* additional defense against long-range missile attacks, and double heat sinks permit the *Titan* to stay in action longer than its predecessors.

The *Titan's* offensive capabilities strike fear into the heart of even the most experienced MechWarrior. Each side of the 'Mech's right arm mounts a Diverse Optics Type 20 large pulse laser, supported by a standard Holly long-range missile battery of 15 launch tubes equipped with an Artemis IV fire-control system.

The *Titan* is equally menacing at short ranges. Using the Artemis IV FCS, the *Titan* carries a Holly short-range missile six-pack in both the right and left torsos. Two Diverse Optics medium pulse lasers increase the medium and short-range fighting capability.

The lead VEST engineer on the *Titan* project, David Courtney Vining, also mounted rear-fire capabilities in response to the new threat of Elementals on the battlefield. Two aft-firing Diverse Optics pulse lasers on the rear left and right torsos discourage close assaults.

Deployment:

The market was ripe for the *Titan*, and all the major Houses purchased the new 'Mech from Earthwerks. House Marik's Free Worlds League bought the majority of the supply.

Type: **Grand Titan**

Technology Base: Inner Sphere

Tonnage: 100

Equipment		Mass
Internal Structure:	Endo Steel	5
Engine:	400 XL	26.5
Walking MP:	4	
Running MP:	6	
Jumping MP:	0	
Heat Sinks:	12 [24]	2
Gyro:		4
Cockpit:		3
Armor Factor:	288	18
	<i>Internal Structure</i>	<i>Armor Factor</i>
Head	3	9
Center Torso	31	42
Center Torso (rear)		19
R/L Torso	21	31
R/L Torso (rear)		11
R/L Arm	17	29
R/L Leg	21	38

T-IT-N10M GRAND TITAN

ASSAULT 'MECHS

01

Weapons and Ammo	Location	Critical	Tonnage
Large Pulse Laser	RA	2	7
Large Pulse Laser	RA	2	7
LRM 15	LA	3	7
Ammo (LRM) 16	LT	2	2
Artemis IV FCS	LA	1	1
SRM 6	RT	2	3
Ammo (SRM) 15	RT	1	1
Artemis IV FCS	RT	1	1
SRM 6	LT	2	3
Ammo (SRM) 15	LT	1	1
Artemis IV FCS	LT	1	1
Medium Pulse Laser	RA	1	2
Medium Pulse Laser	LA	1	2
Small Pulse Laser	RT (R)	1	1
Small Pulse Laser	LT (R)	1	1
Anti-Missile System	H	1	.5
Ammo (Anti-Missile) 12	CT	1	1

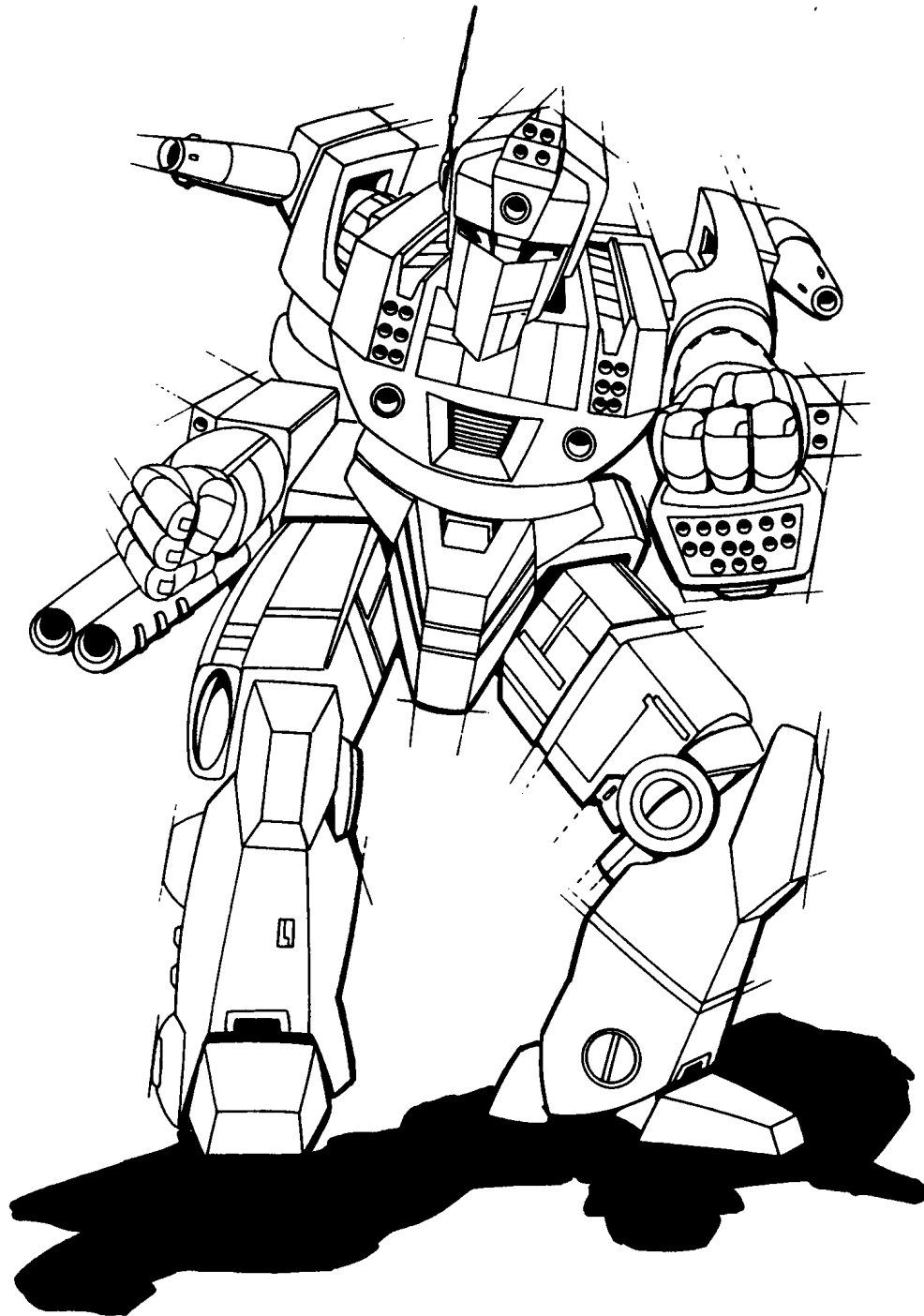



SECONDLINE 'MECHS

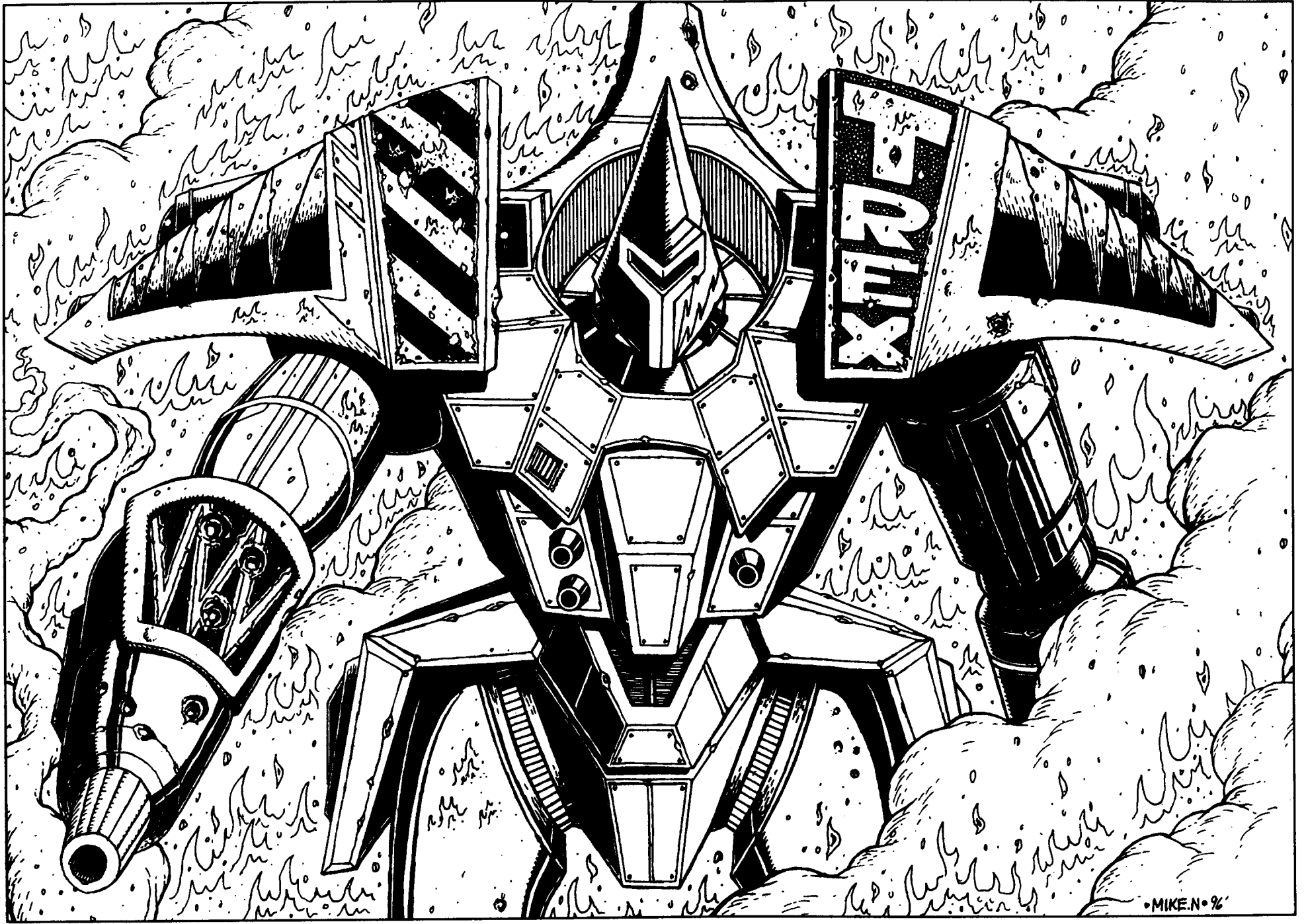

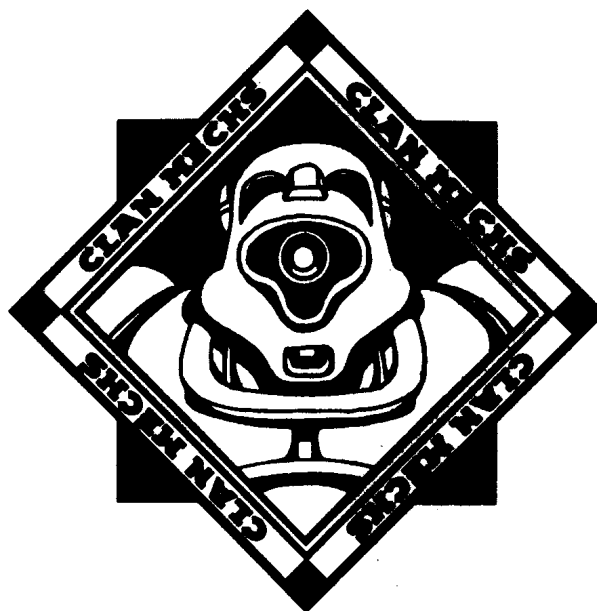

The Clans spearheaded their invasion with front-line forces using OmniMechs, advanced machines that were more than a match for the best the Inner Sphere offered. Now we have encountered their second-line BattleMechs. This section describes four Clan Wolf OmniMechs and 10 BattleMechs seen in Clan garrison forces.

As is common in the Inner Sphere, the Clans deploy their second-line BattleMechs in garrison forces. For Clan warriors, garrison assignments offer far fewer opportunities to earn honor than front-line assignments, and so the BattleMechs themselves carry a stigma, even when deployed in the front lines. Novice MechWarriors or those considered too old to be assigned a precious OmniMech most often pilot the 'Mechs described in this section.

The second-line BattleMechs use the same advanced components as OmniMechs, but are not modular and do not use pods. As with the OmniMechs, CASE-equipped armor is standard on all Clan designs. Because these 'Mechs lack the flexibility of newer Clan designs, the Clans consider their second-line machines obsolete. Inner Sphere commanders must not underestimate forces equipped with these BattleMechs, however; the Clans may consider these BattleMechs inferior, but they are still exceptionally dangerous.

The second-line BattleMechs are identified in this section by the names we gave them at first contact. We have since learned the names the Clans use to identify these units, and so the Clan names are listed below.

Inner Sphere Name

Baboon

Vixen

Peregrine

Hellhound

Goshawk

Clan Name

Howler

Incubus

Horned Owl

Conjurer

Vapor Eagle

Inner Sphere Name

Galahad

Viper

Behemoth

Kraken

Clan Name

Glass Spider

Black Python

Stone Rhino

Bane

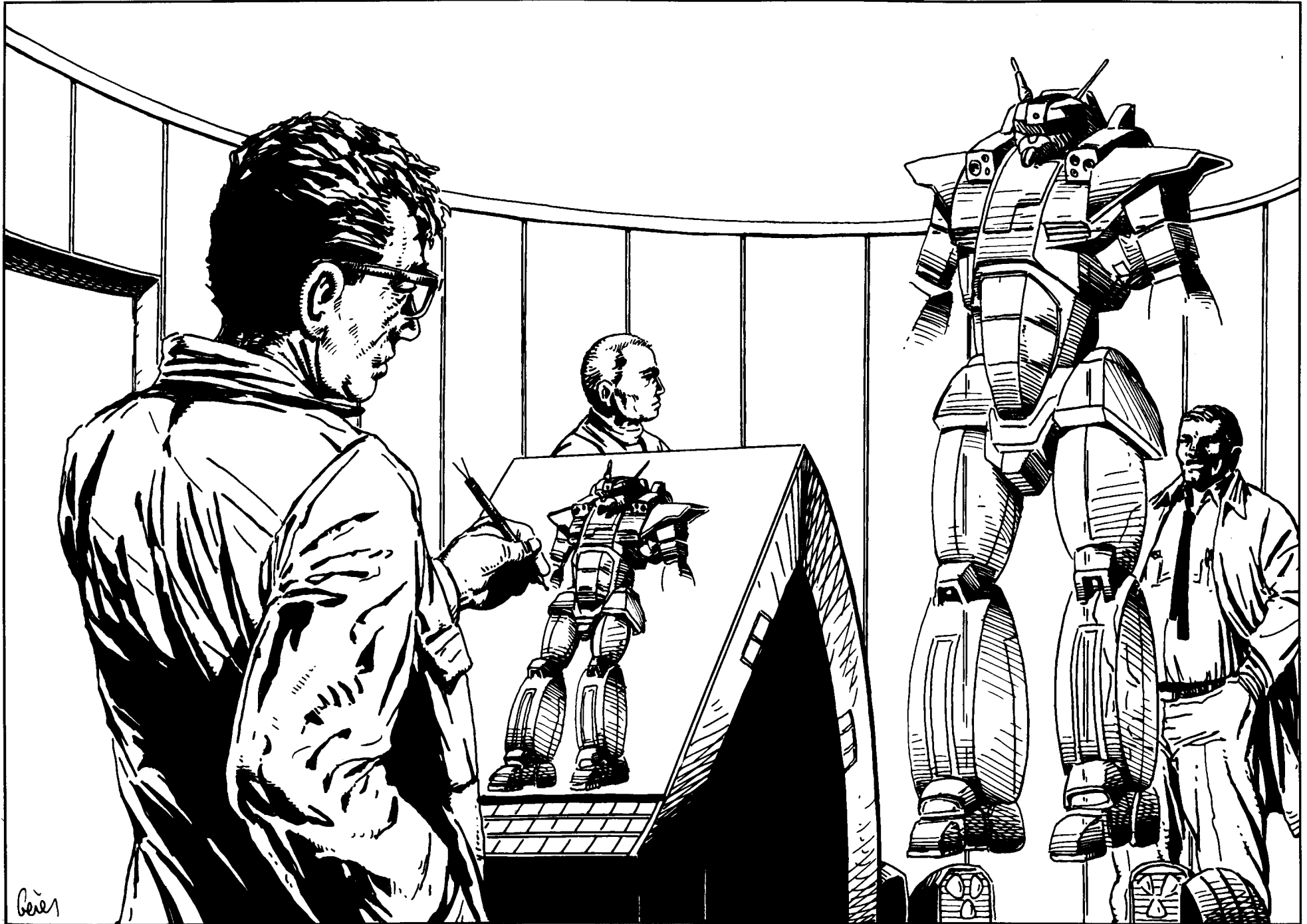

Geis

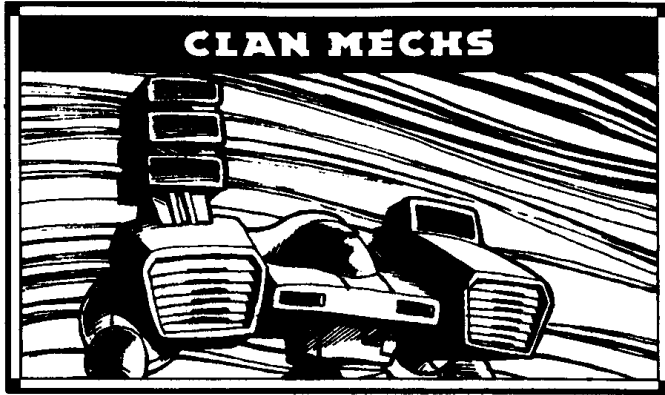

Mass: 20 tons
Chassis: Endo Steel
Power Plant: 140 Standard
Cruising Speed: 75.6 kph
Maximum Speed: 118.8 kph
Jump Jets: None
Jump Capacity: None
Armor: Ferro-Fibrous
Armament:
 3 LRM-5 Racks
Manufacturer: Unknown
Communications System: Unknown
Targeting and Tracking System: Unknown

Overview:

The *Baboon* is a light BattleMech seen only on worlds occupied by the Jade Falcon Clan. No other Clan has been seen using this 'Mech, and we suspect the design is unique to Clan Jade Falcon.

While other Clans garrison their newly captured territories with variants of old Star League designs, the Jade Falcons assign a large proportion of new 'Mechs to their second-line units.

Capabilities:

The *Baboon's* long forearms give the 'Mech an ungainly look, but its speed makes it an excellent fast reconnaissance unit.

The pilots of most light 'Mechs must bring their machines in close to strike. The *Baboon* pilot can keep his distance, because the 'Mech is fitted with superb LRM launchers, which have a flexible strike envelope unparalleled within the Inner Sphere.

A searchlight system gives the *Baboon* superior night-combat abilities, and its flexible torso structure allows the 'Mech to hunch down and reduce the size of its profile for covert operations.

Deployment:

Light BattleMechs filling a reconnaissance role usually offer limited strike capability. Their small size prevents them from carrying the armor needed to stay in the thick of action for any length of time. A commander using fast, light 'Mechs to punch into an enemy formation soon discovers his force's offensive capability degrading quickly.

However, it appears that Clan Jade Falcon holds back these durable 'Mechs for use as reinforcements. Our analysts suspect that the *Baboon* will cause trouble for the Inner Sphere in future battles by turning apparently certain victory to disaster at the last moment.

Type: Howler

Inner Sphere Designation: **Baboon**

Technology Base: Clan

Tonnage: 20

Equipment

		Mass
Internal Structure:	Endo Steel	1
Engine:	140	5
Walking MP:	7	
Running MP:	11	
Jumping MP:	0	
Heat Sinks:	10 [20]	0
Gyro:		2
Cockpit:		3
Armor Factor:	58	3

	Internal Structure	Armor Value
Head	3	7
Center Torso	6	9
Center Torso (rear)		2
R/L Torso	5	7
R/L Torso (rear)		2
R/L Arm	3	5
R/L Leg	4	6

Weapons and Ammo	Location	Critical	Tonnage
LRM 5	RT	1	1
LRM 5	RT	1	1
LRM 5	RT	1	1
Ammo (LRM) 72	RT	3	3

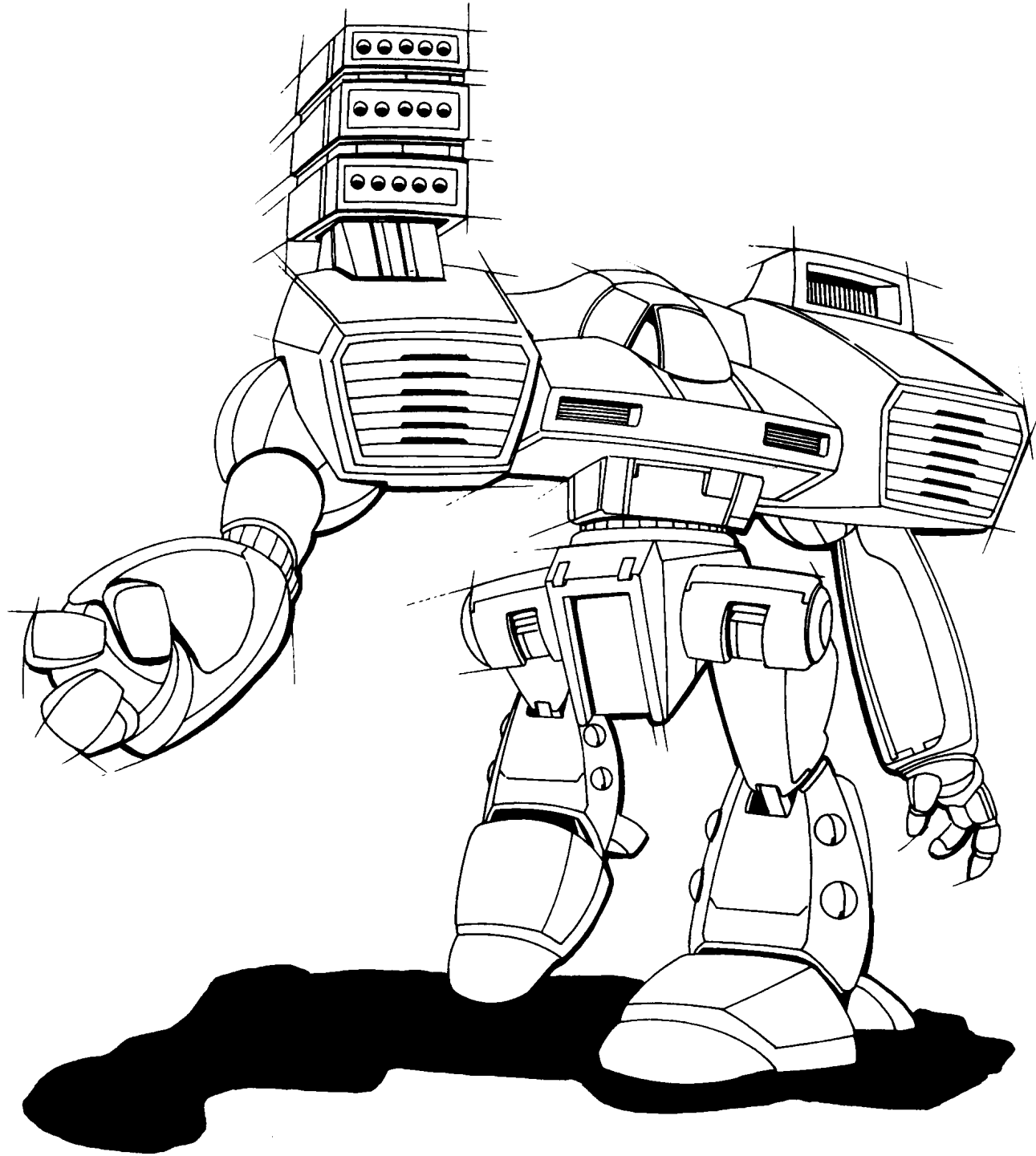

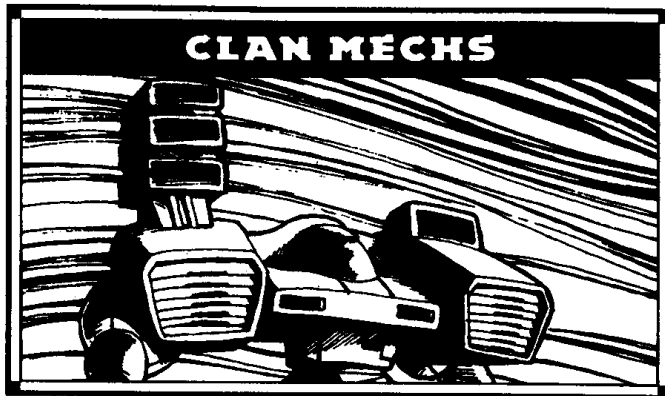

Mass: 30 tons

Chassis: Endo Steel

Power Plant: 270 XL

Cruising Speed: 97.2 kph

Maximum Speed: 151.6 kph

Jump Jets: None

Jump Capacity: None

Armor: Ferro-Fibrous

Armament:

1 Large Pulse Laser

2 Extended Range Medium Lasers

4 Machine Guns

Manufacturer: Unknown

Communications System: Unknown

Targeting and Tracking System: Unknown

Overview:

The *Vixen* is the lightest of five designs never before seen within the Clans. These new designs are not OmniMechs, sharing none of the features that go into the Clan front-line BattleMechs, but if they have a specific battle function, it is still unclear. A small number of *Vixens* have been seen in Jade Falcon garrisons, but nowhere else.

Capabilities:

This light 'Mech is very impressive, somehow managing to look aggressive despite its weight, a definite psychological advantage for the pilot. The arm-mounted primary weapon is supported by over-the-shoulder lasers, making the *Vixen* a threat at any range. Multiple machine guns and exceptional maneuverability make it a potent anti-infantry 'Mech as well.

Deployment:

The *Vixen* has not appeared in action against the Inner Sphere as yet.

Variants:

The *Vixen's* primary weapon system is arm-mounted and therefore semi-modular. Techs can change weaponry quickly using minimal resources, allowing uncomplicated and convenient field modifications. This structure has long been recognized as one of the strengths of Inner Sphere 'Mechs such as the *BattleMaster* and *Wolverine*, and leads to countless undocumented "field variations."

One common *Vixen* variant simply upgrades the primary weapon from a large pulse laser to an extended range PPC. This configuration's disadvantage is that the 'Mech runs hot in combat if all the weapons are fired simultaneously.

A second major variant mounts a Streak SRM-6 launcher. This lighter weapon allows 'Mechs to exchange the extended range medium laser mounted in the torso section for medium pulse lasers. This arrangement creates a very potent medium-range weapons platform.

Type: **Incubus**

Inner Sphere Designation: **Vixen**

Technology Base: Clan

Tonnage: 30

Equipment

		Mass
Internal Structure:	Endo Steel	1.5
Engine:	270 XL	7.5
Walking MP:	9	
Running MP:	14	
Jumping MP:	0	
Heat Sinks:	10 [20]	0
Gyro:		3
Cockpit:		3
Armor Factor:	105	5.5

	Internal Structure	Armor Value
Head	3	9
Center Torso	10	15
Center Torso (rear)		5
R/L Torso	7	10
R/L Torso (rear)		4
R/L Arm	5	10
R/L Leg	7	14

Weapons and Ammo	Location	Critical	Tonnage
Large Pulse Laser	RA	2	6
ER Medium Laser	LT	1	1
Machine Gun	LT	1	.25
Machine Gun	LT	1	.25
ER Medium Laser	RT	1	1
Machine Gun	RT	1	.25
Machine Gun	RT	1	.25
Ammo (MG) 100	CT	1	.5

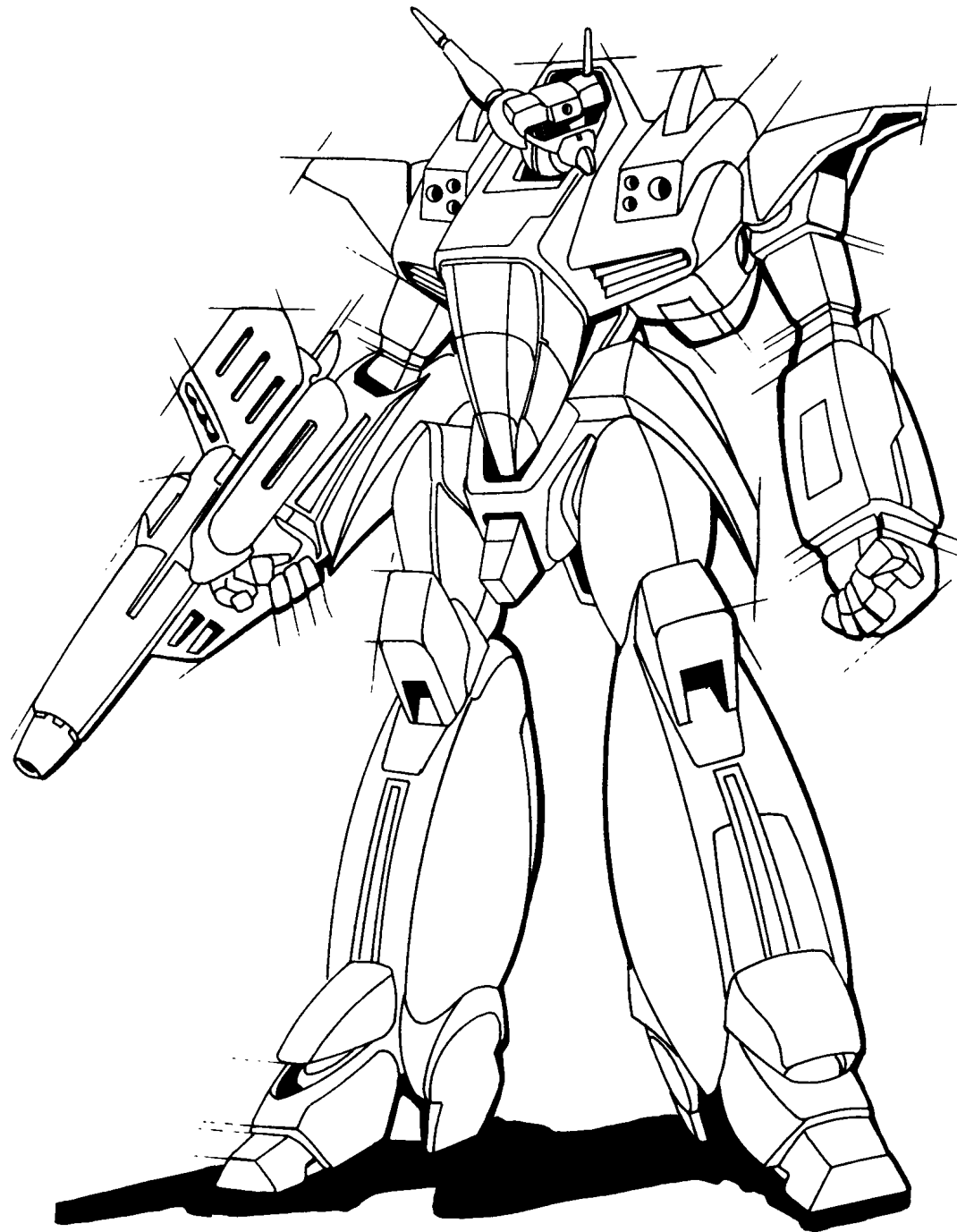

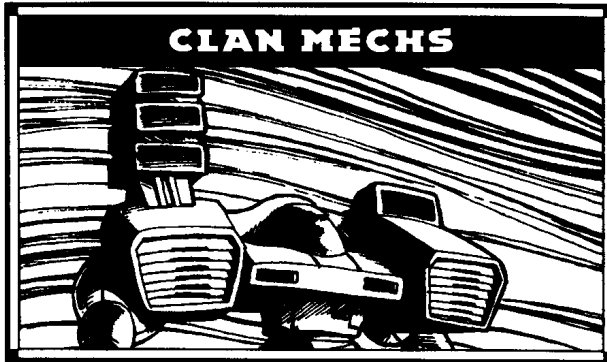

Mass: 35 tons
Chassis: Endo Steel
Power Plant: 315 XL
Cruising Speed: 97 kph
Maximum Speed: 151 kph
Jump Jets: 7
 Jump Capacity: 210 meters
Armor: Ferro-Fibrous
Armament:
 1 Streak SRM-4 Racks
 2 SRM-6 Racks
Manufacturer: Unknown
Communications System: Unknown
Targeting and Tracking System: Unknown

Overview:

The Clan *Jenner* is something of a puzzle to Inner Sphere analysts. All other Inner Sphere refits are based on Star League-era BattleMechs and are the result of centuries of developmental evolution, yet the Clans singled out and upgraded a single post-Exodus Inner Sphere design. The answer may lie in the *Jenner's* inherent speed, which the Clans have exploited to make one of the fastest and most maneuverable BattleMechs in existence.

Capabilities:

In addition to the *Jenner* IIC's remarkable land speed, which rivals that of the 3050 *Hermes*, the Clan *Jenner* is equipped with powerful jump jets enabling it to make leaps in excess of 200 meters. Clan designers have reinforced the center torso and leg armor for increased survivability and have equipped their model with two SRM-6 racks and a Streak SRM-4 rack.

Development:

The *Jenner* IIC appeared in the ranks of the majority of the Clans that took part in the invasion of the Inner Sphere. Of all the Clans, Nova Cat fielded this design most frequently, which suggests that the design originated with Clan Nova Cat and was later distributed to the other Clans.

Variants:

Apparently, only Clan Nova Cat uses variants on the basic *Jenner* design, lending credence to the theory that the 'Mech originated in that Clan. The first of the two variants identified during the invasion replaces the Streak SRM-4 rack with a NARC beacon launcher and the SRM-6 racks with small pulse lasers. This variant was used extensively as a spotter. The second, and considerably less popular, variant switches out the Streak SRM launcher for an LRM-5 rack and replaces the rest of the weapon systems with an ER large laser and a small pulse laser. The *Jenner* IIC V2's weapon combination makes it a tough customer for a 'Mech of its size.

Type: Jenner IIC

Technology Base: Clan

Tonnage: 35

Equipment

		Mass
Internal Structure:	Endo Steel	2
Engine:	315 XL	11
Walking MP:	9	
Running MP:	14	
Jumping MP:	7	
Heat Sinks:	10 [20]	0
Gyro:		4
Cockpit:		3
Armor Factor:	67	3.5

	Internal Structure	Armor Value
Head	3	7
Center Torso	11	13
Center Torso (rear)		7
R/L Torso	8	6
R/L Torso (rear)		3
R/L Arm	6	3
R/L Leg	8	8

Weapons and Ammo	Location	Critical	Tonnage
Streak SRM 4	CT	1	2
Ammo (Streak) 25	RT	1	1
SRM 6	RA	1	1.5
Ammo (SRM) 15	RT	1	1
SRM 6	LA	1	1.5
Ammo (SRM) 15	LT	1	1
Jump Jets	LL	2	1
Jump Jets	RL	2	1
Jump Jet	LT	1	.5
Jump Jet	RT	1	.5
Jump Jet	CT	1	.5

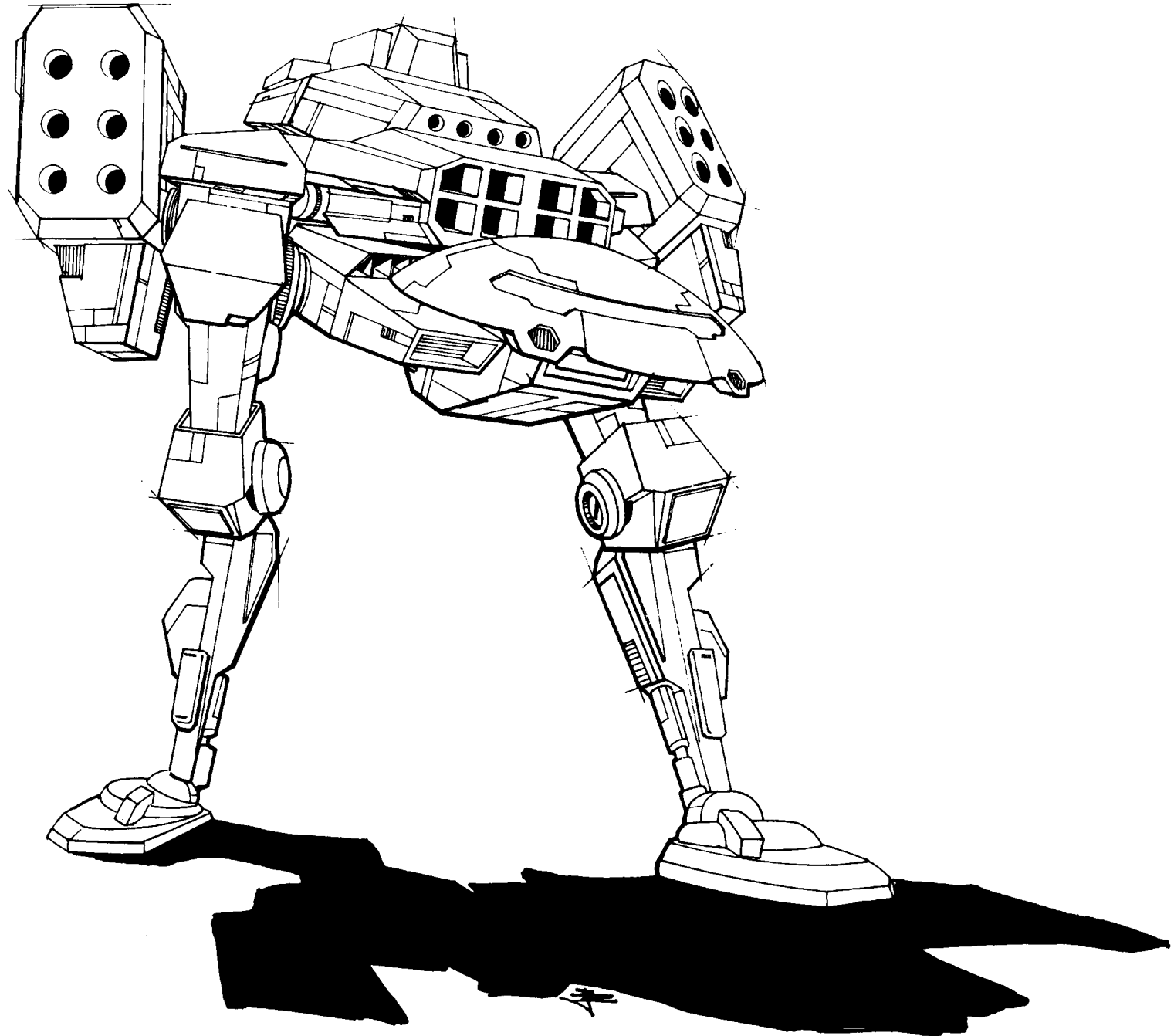

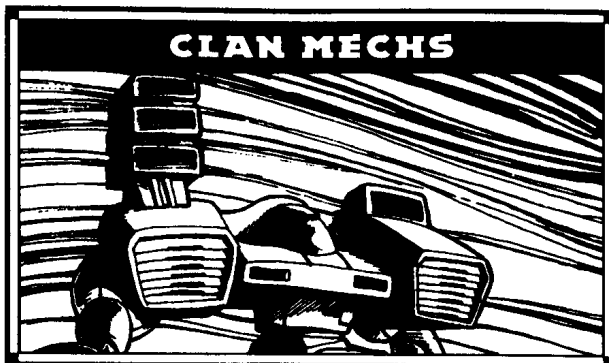

Mass: 35 tons

Chassis: Endo Steel

Power Plant: 210 Standard

Cruising Speed: 60.9 kph

Maximum Speed: 97.2 kph

Jump Jets: 6

Jump Capacity: 180 meters

Armor: Ferro-Fibrous

Armament:

1 Large Pulse Laser

2 Medium Pulse Lasers

Manufacturer: Unknown

Communications System: Unknown

Targeting and Tracking System: Unknown

Overview:

The Clans use BattleMech designs new to the Inner Sphere that obviously predate the OmniMech. The *Peregrine's* design and engine configuration leads us to speculate that it was one of the first generation of new designs built after the Star League army exodus.

We say this with some confidence because strong design similarities exist between this 'Mech and the Clan *Griffin*, *Shadow Hawk*, and *Wolverine*. All become lighter machines in the hands of the Clans, and the *Peregrine* may be the ultimate end product of this weight reduction. Even the name has certain thematic links with its three classic medium 'Mech forebears.

Capabilities:

The carapace of the *Peregrine* represents a cul-de-sac in Clan technological development. Its curved shape is difficult to produce using the ferro-fibrous armor this 'Mech carries. Certain ballistic advantages are gained by bending armor into a rounded shape, but the increased maintenance time for repairing battlefield damage outweighs the benefits.

The pulse lasers are mounted in streamlined pods which drop small covers over the muzzles of the guns. The most obvious advantage of this design is to give the 'Mech a non-threatening appearance, which would make it well suited to guard duties in civilian areas.

Another interesting possibility is that the *Peregrine* was first designed for use in underwater environments. Unfortunately, this is pure speculation, though the expense of producing rounded armor plating for naval operations would be justified by reducing the chances of a hull breach.

Deployment:

The *Peregrine* was first seen in service with Clan Ghost Bear. The *Peregrine's* streamlined appearance and apparent lack of weapons belie its actual fighting potential. At first glance, many observers assume that this 'Mech is the Clan equivalent of the specialized, lightweight security 'Mechs available in the Inner Sphere, but the *Peregrine* is very much a military tool.

Variants:

Clan Smoke Jaguar deploys a radical variant easily distinguished from the basic model by the shoulder-mounted main weapon pods. Keeping the targeting computer for greater firing accuracy, this model replaces the pulse lasers with six LRM-5 launchers, three mounted on each torso in distinctive bins. Each torso also carries two tons of ammunition, providing 16 rounds to each launcher; ample for most assignments.

The Smoke Jaguars commonly deploy mixed Stars of *Peregrines*, using three standard models and two missile-support variants. Together they are a fearsome combination.

Type: **Horned Owl**

Inner Sphere Designation: **Peregrine**

Technology Base: Clan

Tonnage: 35

Equipment

		Mass
Internal Structure:	Endo Steel	2
Engine:	210	9
Walking MP:	6	
Running MP:	9	
Jumping MP:	6	
Heat Sinks:	10 [20]	0
Gyro:		3
Cockpit:		3
Armor Factor:	96	5

	Internal Structure	Armor Value
Head	3	9
Center Torso	11	13
Center Torso (rear)		6
R/L Torso	8	10
R/L Torso (rear)		4
R/L Arm	6	9
R/L Leg	8	11

Weapons and Ammo	Location	Critical	Tonnage
Large Pulse Laser	CT	2	6
Medium Pulse Laser	LA	1	2
Medium Pulse Laser	RA	1	2
Jump Jets	RL	2	1
Jump Jets	LL	2	1
Jump Jet	RT	1	.5
Jump Jet	LT	1	.5

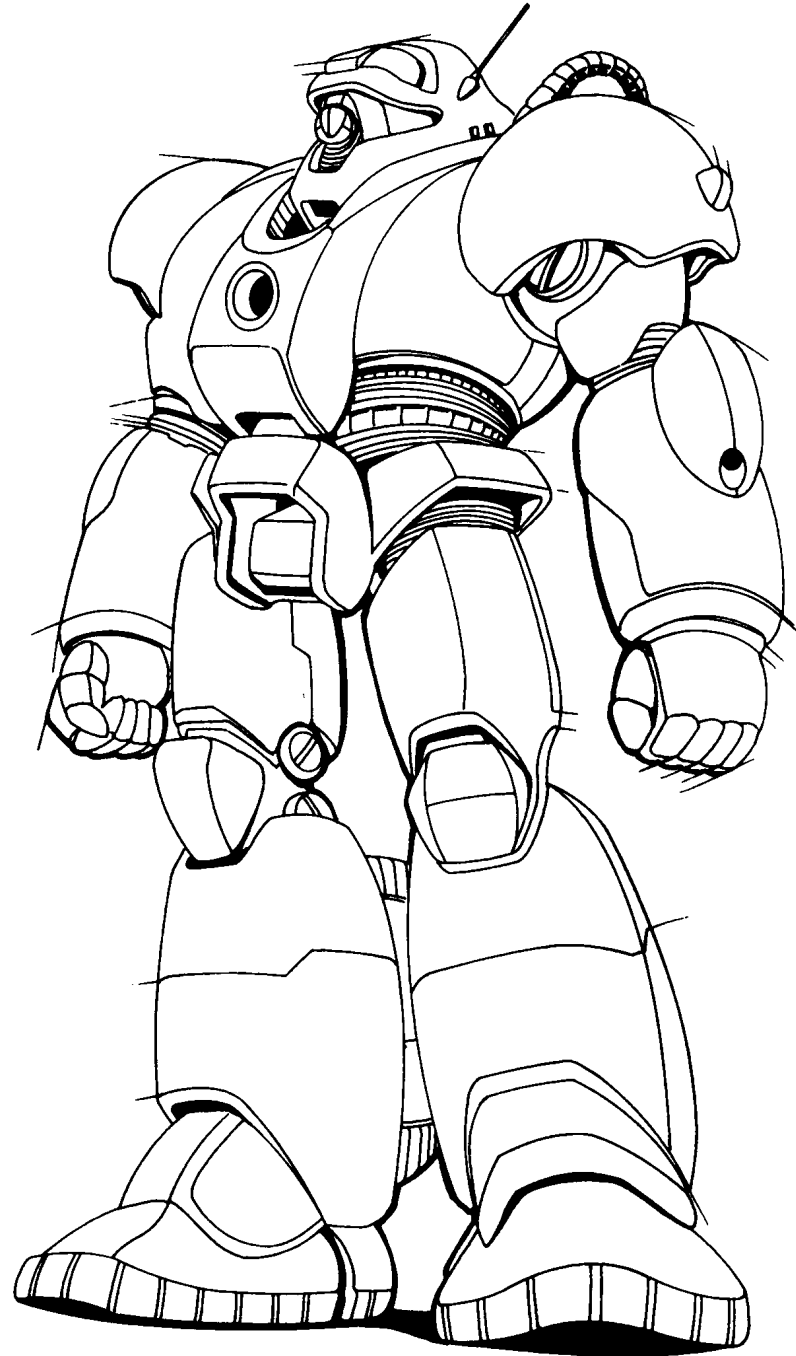

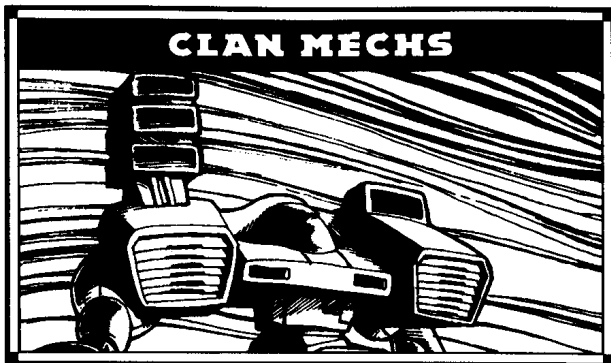

Mass: 50 tons
Chassis: Endo Steel
Power Plant: 300 Standard
Cruising Speed: 60.9 kph
Maximum Speed: 97.2 kph
Jump Jets: 6

Jump Capacity: 180 meters
Armor: Ferro-Fibrous

Armament:
 1 Large Pulse Laser
 2 Extended Range Medium Lasers
 2 Streak SRM-2 Racks

Manufacturer: Unknown
Communications System: Unknown
Targeting and Tracking System: Unknown

Overview:

Originally produced as a fast 'Mech designed to take a lot of punishment, the *Hellhound* could generally outrun anything that out-gunned it. Considered only marginally successful in the beginning, the *Hellhound* built its reputation as one of the best medium 'Mechs in operation.

Capabilities:

The primary armament arrangement is a large pulse laser and a shoulder-mounted missile support system, backed up by twin extended-range medium lasers mounted in the right torso.

Jumping capability to the maximum range possible for the weight of the 'Mech gives the *Hellhound* an added edge in combat. Clan technicians have used the advanced technology available to produce a perfect blend of speed and striking power.

Deployment:

The *Hellhound* is used by Clan Jade Falcon, and has become a particularly feared sight in the Federated Commonwealth. The *Hellhound* demonstrates its tactical flexibility in all its assigned tasks, including recent forays as light 'Mech hunter-killers.

Type: Conjurer
Inner Sphere Designation: Hellhound
Technology Base: Clan
Tonnage: 50

Equipment		Mass
Internal Structure:	Endo Steel	2.5
Engine:	300	19
Walking MP:	6	
Running MP:	9	
Jumping MP:	6	
Heat Sinks:	10 [20]	0
Gyro:		3
Cockpit:		3
Armor Factor:	163	8.5
	<i>Internal Structure</i>	<i>Armor Value</i>
Head	3	9
Center Torso	16	23
Center Torso (rear)		7
R/L Torso	12	19
R/L Torso (rear)		5
R/L Arm	8	14
R/L Leg	12	24

Weapons and Ammo	Location	Critical	Tonnage
Large Pulse Laser	RA	2	6
ER Medium Laser	RT	1	1
ER Medium Laser	RT	1	1
Streak SRM 2	LT	1	1
Streak SRM 2	LT	1	1
Ammo (Streak) 50	LT	1	1
Jump Jets	CT	2	1
Jump Jets	LT	2	1
Jump Jets	RT	2	1

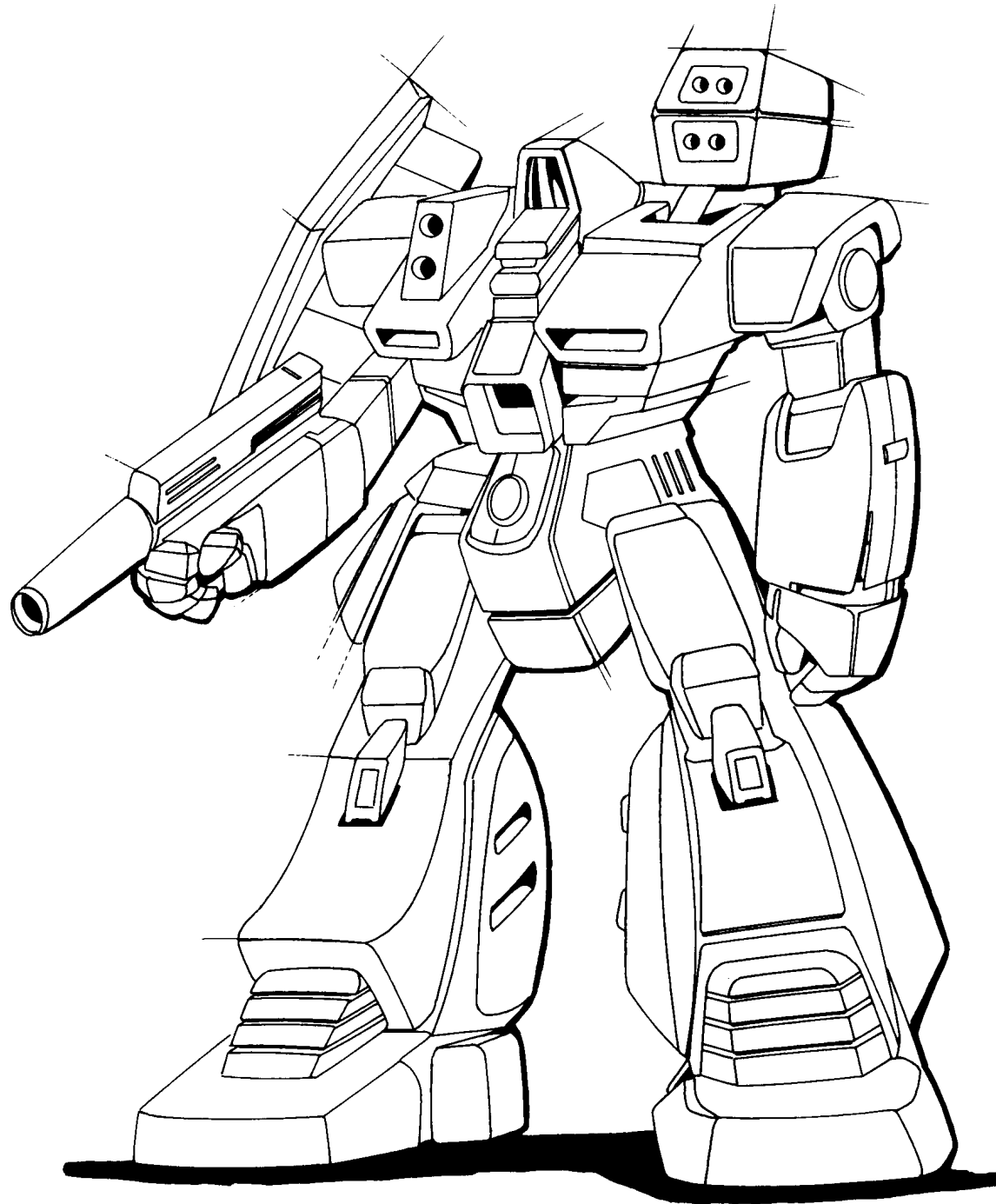

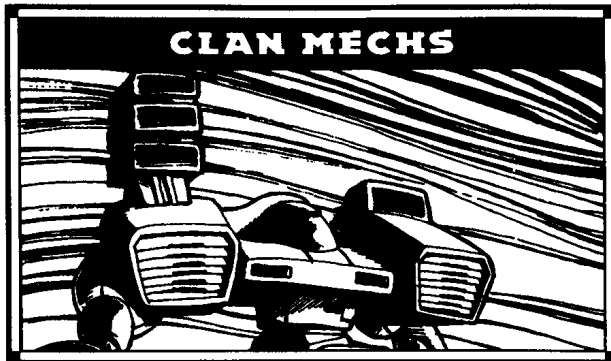

Mass: 55 tons
Chassis: Endo Steel
Power Plant: 330 XL
Cruising Speed: 60.9 kph
Maximum Speed: 97.2 kph
Jump Jets: 6
Jump Capacity: 180 meters
Armor: Ferro-Fibrous
Armament:
 1 Large Pulse Laser
 2 Streak SRM-2 Racks
 3 Medium Pulse Lasers
 4 Machine Guns
Manufacturer: Unknown
Communications System: Unknown
Targeting and Tracking System: Unknown

Overview:

The *Goshawk* is another of the five new BattleMechs that we have dubbed "Series 2" fielded by the Steel Viper Clan. As with the *Vixen*, it represents a new line of development in 'Mech design, each machine carrying distinctive features whose functions remain a mystery to us. Given their operational parameters, the most likely purpose for this new line is as arena combat 'Mechs. While this conclusion seems absurd, it best explains the unusual design of these 'Mechs and could account for the sometimes bizarre weapon combinations.

Capabilities:

The *Goshawk* incorporates large arm baffles, a familiar feature of the *Griffin*. On the *Goshawk*, however, they serve a different function. The *Griffin's* arm baffles act as blast deflectors, while the *Goshawk* uses them for jumping. Most designers agree that when a 'Mech jumps, it is largely an act of brute force over aerodynamics, as most 'Mechs have all the aerodynamic stability of a brick. The *Goshawk* attempts to rectify this situation with stabilizing wings. These small wings in themselves provide negligible lift, and so some of the thrust from the torso jump jets is diverted over their surface. This action produces a very controllable jump flight and provides smooth and precise landings.

Deployment:

These 'Mechs have not seen action against Inner Sphere forces, but have only been spotted in Steel Viper garrison units during reconnaissance missions, further obscuring their true purpose.

Variants:

Though it is not an OmniMech, the *Goshawk* seems to come in a wide variety of weapon configurations, leading to speculations on exactly what purpose these machines serve in the Steel Viper Clan organization. The *Goshawk* primary variant is the one listed here.

The most common variant drops one double heat sink, keeps the machine guns and targeting computer, and replaces the remaining weapons with an Ultra-10 autocannon and medium pulse laser. The autocannon is mounted in the left torso similar to the Inner Sphere *Shadow Hawk*, while the laser is in a blister pod on the right arm. The twenty rounds of ammunition provided for the autocannon is clearly inadequate for the double rate of fire at which the Ultra cannon is designed to be used.

Type: Vapor Eagle

Inner Sphere Designation: **Goshawk**
 Technology Base: Clan
 Tonnage: 55

Equipment

		Mass
Internal Structure:	Endo Steel	3
Engine:	330 XL	12.5
Walking MP:	6	
Running MP:	9	
Jumping MP:	6	
Heat Sinks:	11 [22]	1
Gyro:		4
Cockpit:		3
Armor Factor:	173	9

	Internal Structure	Armor Value
Head	3	9
Center Torso	18	29
Center Torso (rear)		5
R/L Torso	13	20
R/L Torso (rear)		5
R/L Arm	9	16
R/L Leg	13	24

Weapons and Ammo	Location	Critical	Tonnage
Large Pulse Laser	RA	2	6
Medium Pulse Laser	LT	1	2
Streak SRM 2	LT	1	1
Ammo (Streak) 50	LT	1	1
Medium Pulse Laser	RT	1	2
Medium Pulse Laser	RT	1	2
Targeting Computer	RT	3	3
Streak SRM 2	RT	1	1
3 Machine Guns	LA	3	.75
Machine Gun	LT	1	.25
Ammo (MG) 100	LA	1	.5
Jump Jets	LL	2	1
Jump Jets	RL	2	1
Jump Jet	LT	1	.5
Jump Jet	RT	1	.5

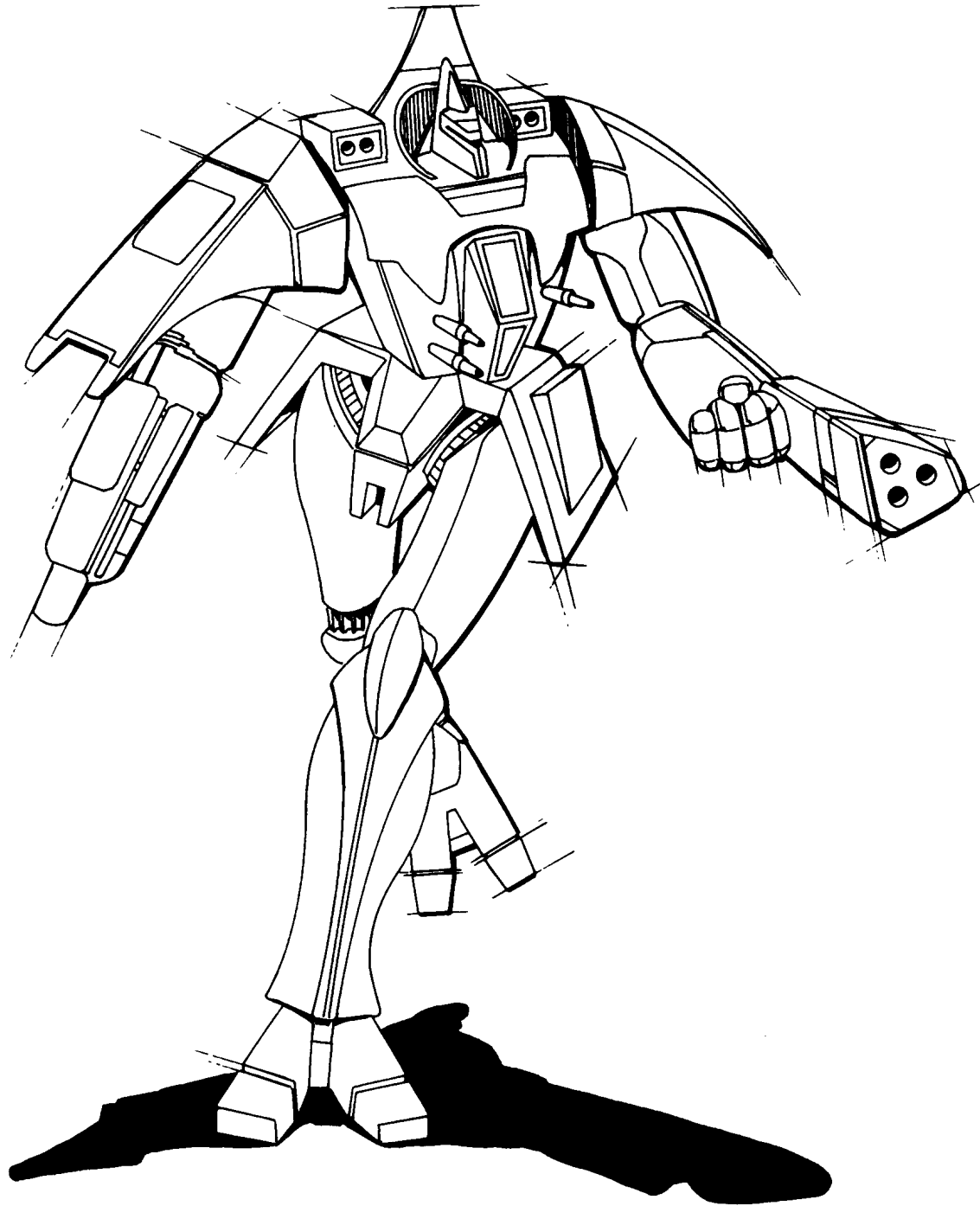

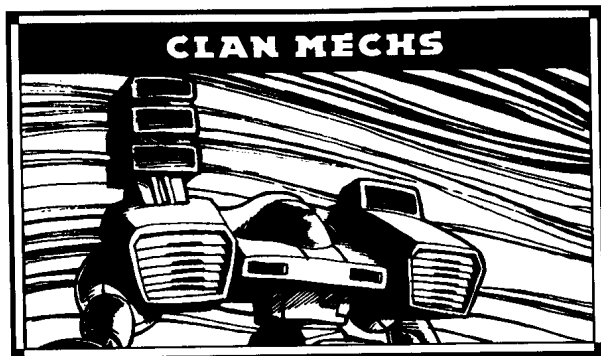

Mass: 60 tons
Chassis: Endo Steel
Power Plant: 240 Standard
Cruising Speed: 43.2 kph
Maximum Speed: 64.8 kph
Jump Jets: None
Jump Capacity: None
Armor: Ferro-Fibrous
Armament:
 2 Gauss Rifle
Manufacturer: Unknown
Communications System: Unknown
Targeting and Tracking System: Unknown

Overview:

The *Galahad* was first seen on the battlefields at the beginning of the 26th century. The original version launched was considered a medium fire-support 'Mech. Problems with overheating forced a redesign and a consequent increase in weight. The revised *Galahad* still failed to meet the hopes of its design team, and it took two centuries for this version to appear on the battlefield.

Based on everything we knew about the Clans, we expected their forces to include the *Galahad*. In fact, two versions of this popular 'Mech appear in their ranks.

Capabilities:

Armed with twin Gauss rifles, this 60-ton BattleMech offers excellent striking power but lacks the armor to take the punishment a larger 'Mech should

withstand. As a result, the *Galahad* is assigned almost exclusively to fire-support missions, out of the way of direct combat.

The Gauss rifle represents the main advantage of the *Galahad*, especially the 'Mech's dreaded ability to flip those weapons over and bring all its firepower to bear in the rear arc in the same manner as the *Rifleman*. Most MechWarriors discount the *Galahad*'s rear firing arc because its rear armor is very thin. While this is still largely true even of the Clan version, detractors sometimes forget that this 'Mech is about fire-support, in particular against airborne targets.

The *Galahad* is a good example of design meeting intent, and the rotating weapons allow the pilot to track a target quickly and efficiently. While this 'Mech is unpopular as a unit assignment for trueborn warriors, it appears to be a favorite for honor duels where a 'Mech must battle an aerofighter.

Deployment:

The *Galahad* is a common sight to raiding forces, because it provides the first line of air defense on the ground for most garrison units. MechWarriors from the Inner Sphere especially respect this design, having found to their cost that an attacker cannot always close quickly enough to overpower the *Galahad*'s relatively light armor.

The Gauss rifle-armed variant is common among the Wolf Clan garrison units. Even though providing fire support is an unpopular assignment, the *Galahad* can bring enough firepower to bear on a target to make killing the opposing 'Mech and thereby gaining honor quite likely.

Variants:

Clan Wolf reconfigures some of their *Galahad* 'Mechs by replacing the Gauss rifle in each arm with large pulse lasers, filling the unneeded ammunition space with two medium pulse lasers in the left torso and three small pulse lasers in the right. This variant also has six extra heat sinks and five tons of targeting computer gear mounted in the center torso, creating an even more accurate fire-support weapons platform.

Type: Glass Spider
Inner Sphere Designation: Galahad
Technology Base: Clan
Tonnage: 60

Equipment		Mass
Internal Structure:	Endo Steel	3
Engine:	240	11.5
Walking MP:	4	
Running MP:	6	
Jumping MP:	0	
Heat Sinks:	10 [20]	0
Gyro:		3
Cockpit:		3
Armor Factor:	201	10.5
	<i>Internal Structure</i>	<i>Armor Value</i>
Head	3	9
Center Torso	20	30
Center Torso (rear)		10
R/L Torso	14	20
R/L Torso (rear)		8
R/L Arm	10	20
R/L Leg	14	28

Weapons and Ammo	Location	Critical	Tonnage
Gauss Rifle	LA	6	12
Ammo (Gauss) 16	LA	2	2
Gauss Rifle	RA	6	12
Ammo (Gauss) 16	RA	2	2
Ammo (Gauss) 8	CT	1	1

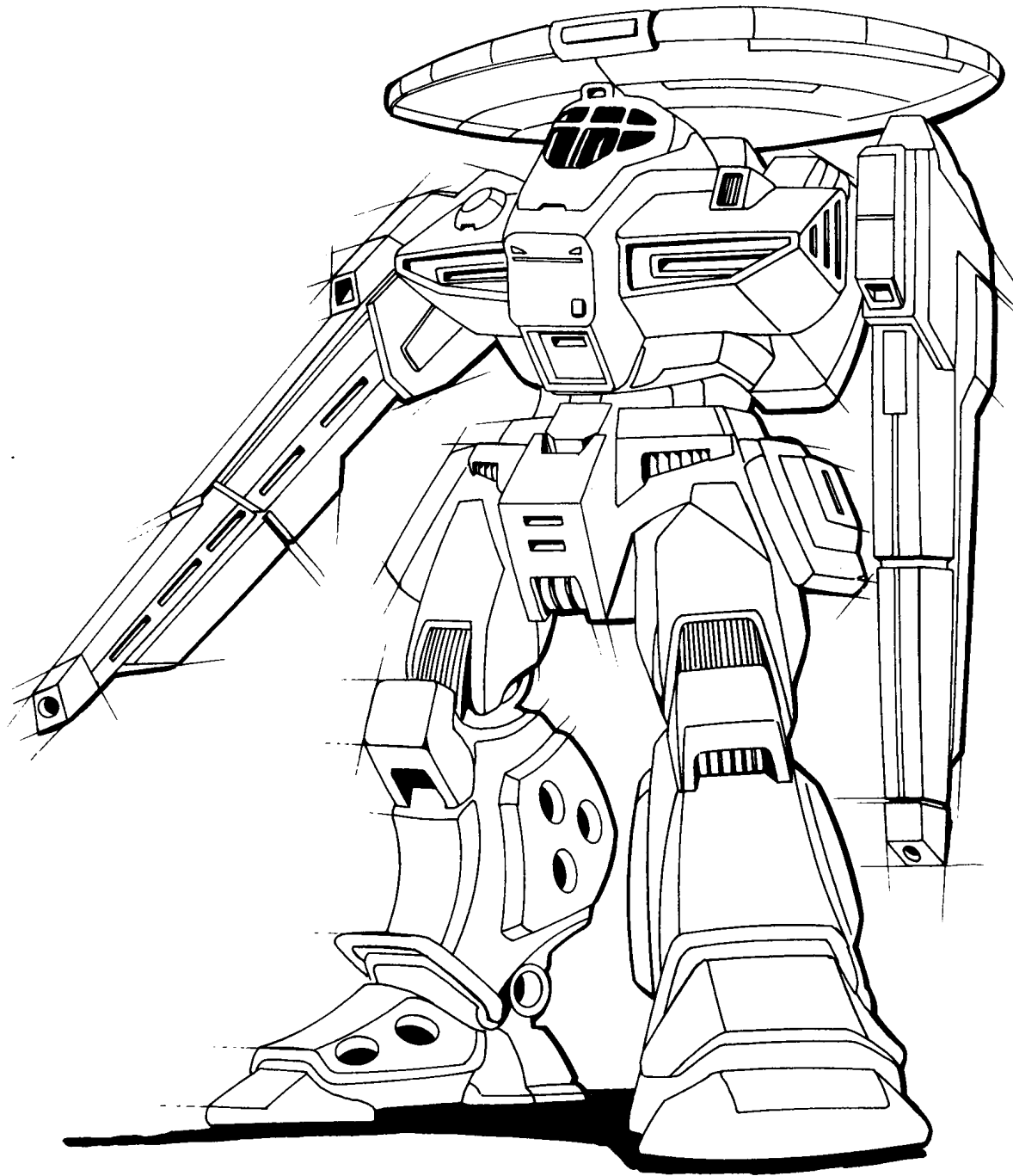

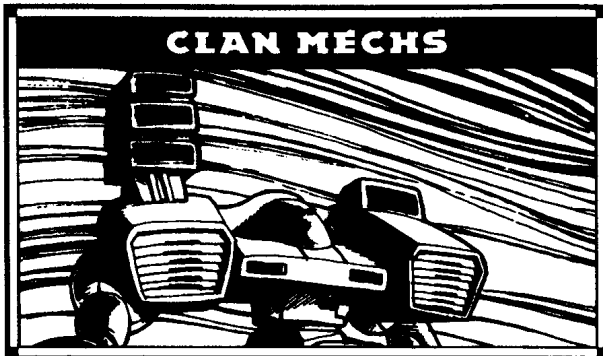

Mass: 75 tons
Chassis: Endo Steel
Power Plant: 375 XL
Cruising Speed: 54.0 kph
Maximum Speed: 86.4 kph
Jump Jets: 5
Jump Capacity: 150 meters
Armor: Ferro-Fibrous
Armament:
 2 Large Pulse Lasers
 2 Medium Pulse Lasers
 4 Small Pulse Lasers
 2 Machine Guns
Manufacturer: Unknown
Communications System: Unknown
Targeting and Tracking Systems: Unknown

Overview:

The *Viper* is a heavy BattleMech available only to Clan Steel Viper. A second *Steel Viper* heavy 'Mech, the *Matador*, is a formidable machine, but the *Viper's* combination of weaponry is far better balanced. The *Viper* has the firepower of an Inner Sphere *Warhammer* or *Marauder*, and the *BattleMaster's* capacity for taking damage.

This combination of armor and firepower is further enhanced with extraordinary speed, making this 'Mech a deadly battlefield opponent. This machine can currently catch and destroy all the significant medium 'Mechs the Inner Sphere deploys.

Capabilities:

The *Viper* is a large, very fast heavy 'Mech. The standard weapon layout consists of paired large and medium pulse lasers in each torso, augmented by small pulse lasers mounted on each side of the 'Mech's forward facing. All the weapons are tied to a targeting computer, placed in the heavily armored torso, which gives the 'Mech deadly accurate firing abilities. A pair of secondary machine gun are fitted to the left arm, giving the pilot minimal anti-infantry suppression fire.

The 'Mech is fully jump capable, and as on the *Goshawk* and *Matador*, thrust from the jump jets is passed over control surfaces to stabilize flight. Angular armor plating to deflect blast damage away from the point of impact creates a striking profile which makes the *Viper* easy to identify on the battlefield.

Its four-pulse-laser combination provides the *Viper* with a balance of firepower the equal of any other 'Mech in its weight class. That firepower aimed by the deadly accurate Clan targeting computer system forms a weapons platform of unparalleled accuracy. As battlefield analysts like to point out, the biggest weapon on the battlefield is of no importance if the pilot cannot hit the target; the *Viper* weapon system is not the biggest available, but its chances of hitting the target approach near certainty. The *Viper* demands, and should receive, a healthy respect from its opponents.

Deployment:

As with all new Steel *Viper* 'Mechs, no substantiated combat reports are available. Computer projections, however, pronounce this 'Mech a deadly machine, and this will no doubt be confirmed by the first raiders to face this design.

Variants:

One *Viper* variant uses alternate weapons in place of everything but the machine gun and small pulse lasers. In place of the twin laser combination in the torso sections, this variant carries a combination of an Ultra-2 autocannon plus two tons of ammunition and extended range large laser. A second small pulse laser is fitted to the head and a reduced one-ton targeting computer is

tied into the aiming circuits. The *Viper* loses a double heat sink in this variant, but this should not adversely affect its combat ability as long as the pilot alternates firing the small lasers with one of the large.

Type: Black Python
Inner Sphere Designation: *Viper*
Technology Base: Clan
Tonnage: 75

Equipment		Mass
Internal Structure:	Endo Steel	4
Engine:	375 XL	19.5
Walking MP:	5	
Running MP:	8	
Jumping MP:	5	
Heat Sinks:	13 [26]	3
Gyro:		4
Cockpit:		3
Armor Factor:	211	11
	<i>Internal Structure</i>	<i>Armor Value</i>
Head	3	9
Center Torso	23	30
Center Torso (rear)		12
R/L Torso	16	22
R/L Torso (rear)		10
R/L Arm	12	22
R/L Leg	16	26

Weapons and Ammo	Location	Critical	Tonnage
Large Pulse Laser	LT	2	6
Medium Pulse Laser	LT	1	2
Small Pulse Laser	LT	1	1
Small Pulse Laser	LT	1	1
Large Pulse Laser	RT	2	6
Medium Pulse Laser	RT	1	2
Small Pulse Laser	RT	1	1
Small Pulse Laser	RT	1	1
Targeting Computer	RA	4	4
2 Machine Guns	LA	2	.5
Ammo (MG) 200	LA	1	1
Jump Jet	CT	1	1
Jump Jets	LT	2	2
Jump Jets	RT	2	2

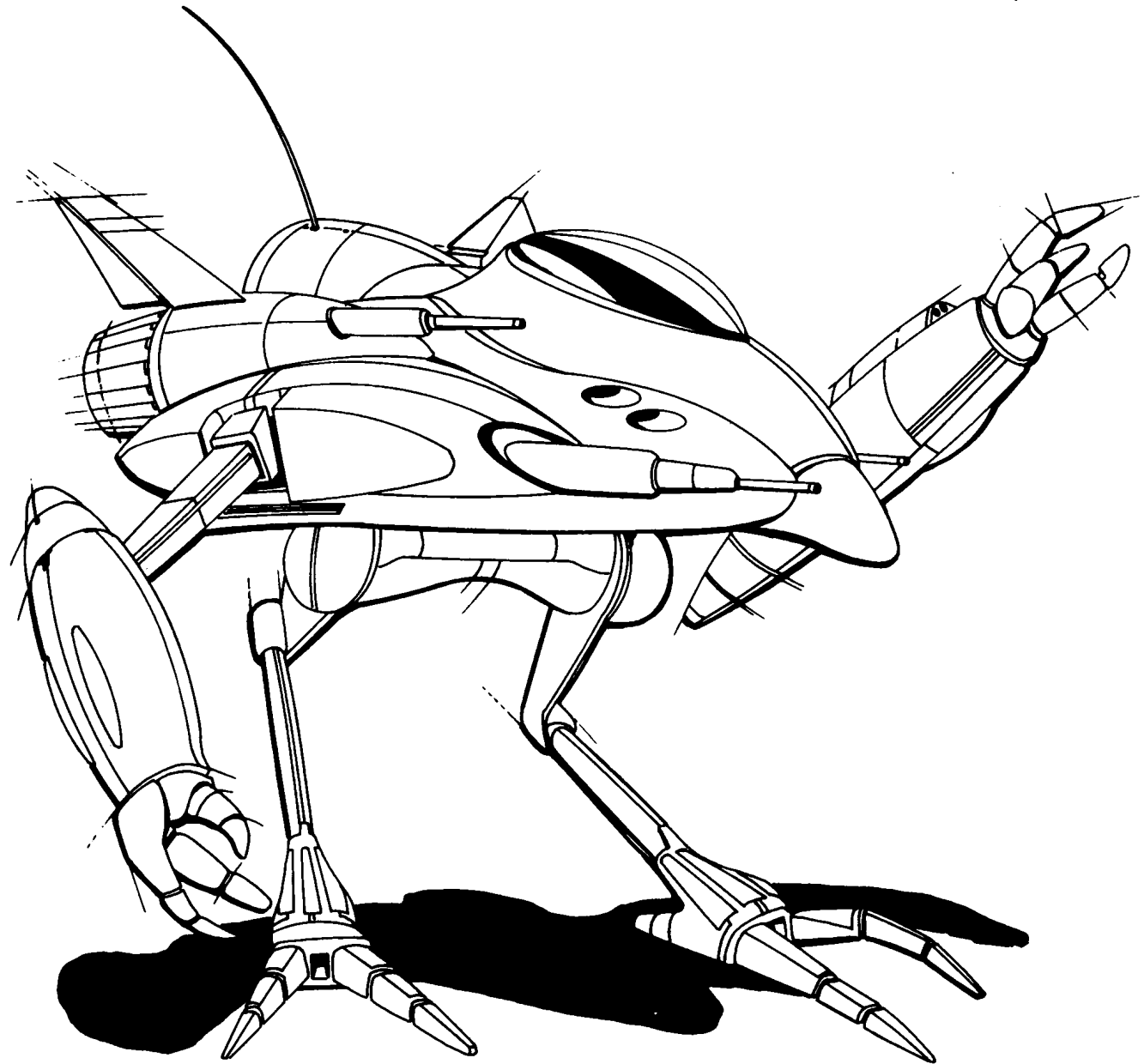

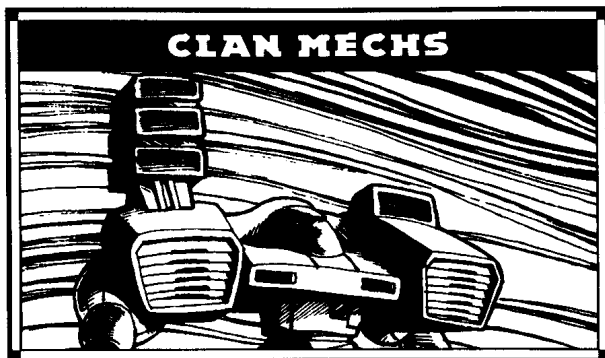

Mass: 100 tons
Chassis: Standard
Power Plant: 300 Standard
Cruising Speed: 32.4 kph
Maximum Speed: 54.0 kph
Jump Jets: 3
 Jump Capacity: 90 meters
Armor: Standard
Armament:
 2 Large Pulse Lasers
 2 Gauss Rifles
 1 Small Pulse Laser
Manufacturer: Unknown
Communications System: Unknown
Targeting and Tracking System: Unknown

Overview:

Of the many surprises the Clans have sprung on us, the *Behemoth* is one of the most remarkable. The original design was considered a grand mistake, and is known to historians as Amaris' folly. The *Behemoth* was the first BattleMech produced by an optimistic project whose objective was to develop a 'Mech capable of withstanding an assault by an entire standard BattleMech company. These machines were to be put into mass production and used to stop General Kerensky from retaking Terra. The prototype is described as a lumbering monstrosity whose leg actuators shut down during its first test run, causing the project to be summarily scrapped.

Apparently the historians were wrong.

Capabilities:

The *Behemoth* weighs in at a massive 100 tons, comparable to the largest 'Mechs ever manufactured. While such machines bring awesome firepower to the battlefield, ultimately, commanders cannot use them effectively because they cannot afford to lose one.

The *Behemoth* features twin Gauss rifles, a large pulse laser mounted in each arm and an almost superfluous small pulse laser. The arm-mounted weapons feature retractable shock-absorbing cowls covering the barrels which allow the pilot to use the arms as battering rams without damaging the delicate laser assemblies.

Deployment:

A small number of these 'Mechs have been sighted in the Smoke Jaguar Clan. No other Clan appears to field this design, but because it is a venerable design, we suspect that the few existing are widely spread throughout the Clans.

Type: Stone Rhino
Inner Sphere Designation: Behemoth
Technology Base: Clan
Tonnage: 100

Equipment		Mass
Internal Structure:		10
Engine:	300	19
Walking MP:	3	
Running MP:	5	
Jumping MP:	3	
Heat Sinks:	10 [20]	0
Gyro:		3
Cockpit:		3
Armor Factor:	288	18
	<i>Internal Structure</i>	<i>Armor Value</i>
Head	3	9
Center Torso	31	46
Center Torso (rear)		15
R/L Torso	21	27
R/L Torso (rear)		14
R/L Arm	17	32
R/L Leg	21	36

Weapons and Ammo	Location	Critical	Tonnage
Large Pulse Laser	LA	2	6
Large Pulse Laser	RA	2	6
Gauss Rifle	LT	6	12
Ammo (Gauss) 16	LT	2	2
Gauss Rifle	RT	6	12
Ammo (Gauss) 16	RT	2	2
Small Pulse Laser	H	1	1
Jump Jet	RL	1	2
Jump Jet	LL	1	2
Jump Jet	CT	1	2

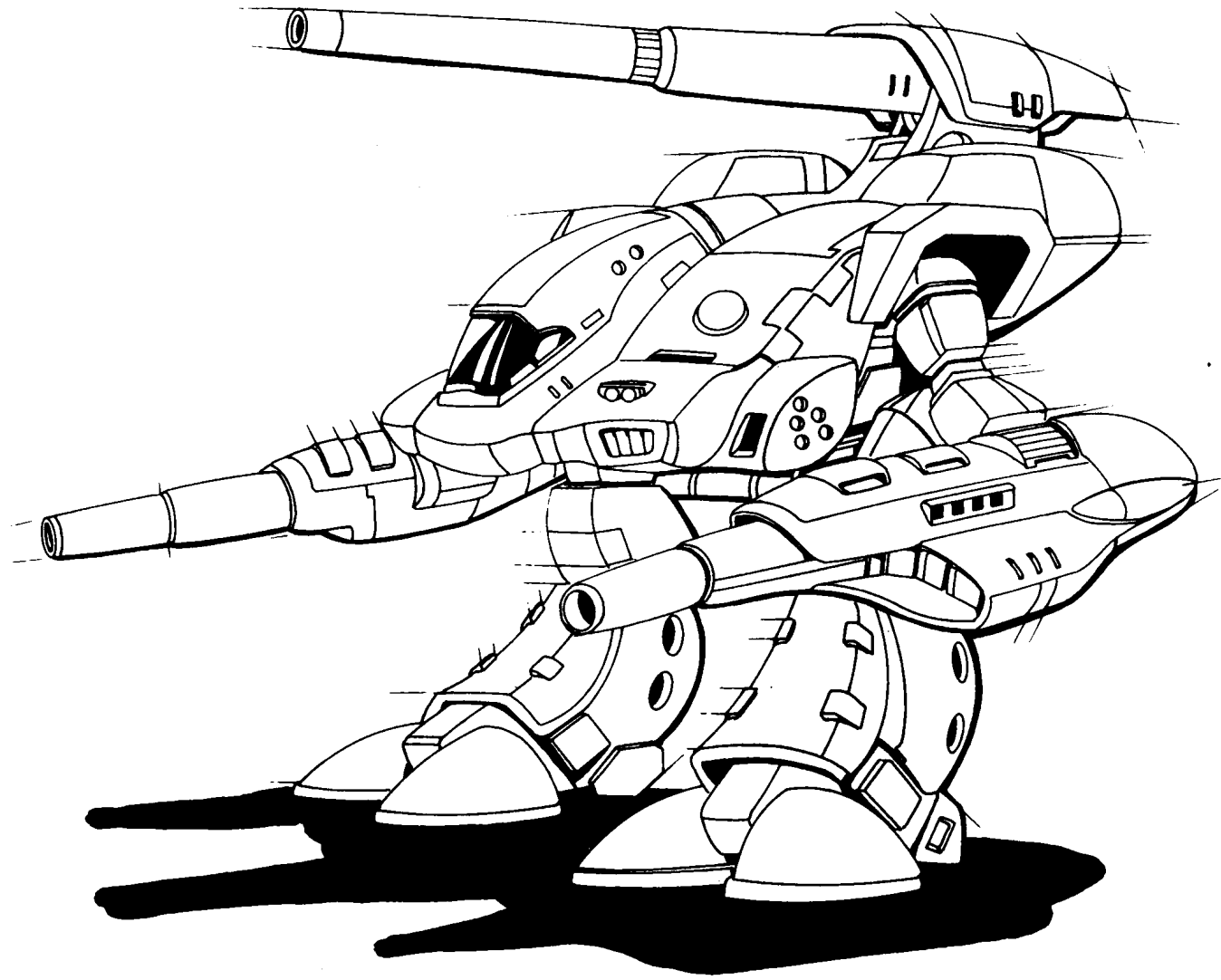

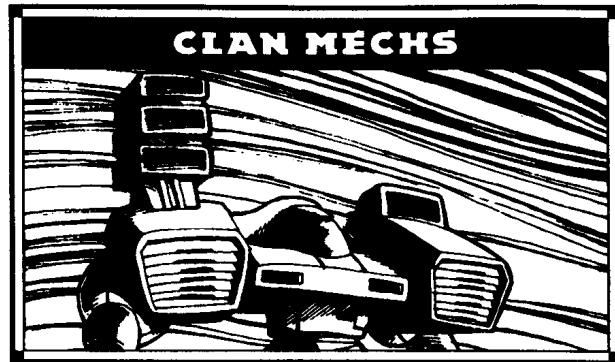

Mass: 100 tons
Chassis: Standard
Power Plant: 300 XL
Cruising Speed: 32.4 kph
Maximum Speed: 54.0 kph
Jump Jets: None
 Jump Capacity: None
Armor: Standard
Armament:
 10 Ultra-2 Autocannons
 4 Machine Guns
Manufacturer: Unknown
Communications System: Unknown
Targeting and Tracking System: Unknown

Overview:

The *Kraken* is the heaviest design of the new Clan 'Mechs and appears to be an intermediate stage between the old Star League 'Mechs and the current generation of OmniMechs.

Capabilities:

The primary weapons are mounted in the arms, with the ammunition supply stored in the left and right torsos, which are equipped with CASE. Because the 'Mech carries an XL fusion engine, an ammunition explosion in a torso location will do considerable damage to the machine.

The designers attempted to reduce the cumulative recoil effects of firing multiple autocannons by incorporating a complex baffle and pressure counterflow system, which vents exhaust gases in such a way as to actually increase the 'Mech's stability when firing, into each arm. They also took care of the problem of main-frame strain with an ingenious arm-linkage design.

Deployment:

So far, this 'Mech appears only in small numbers on Jade Falcon-held worlds. However, so many variants exist that we surmise they are either short-run prototypes or are being customized for reasons known only to the Steel Viper Khans.

Variants:

The most common variant of the *Kraken* is armed with multiple Ultra-2 autocannons in each arm. A pilot attacking with this configuration can efficiently spread the damage across the weak spots of any target. Two other variants of this 'Mech serve Clan Jade Falcon.

The first replaces each arm's multiple Ultra-2 autocannons with two Ultra-10 autocannons. A staggering seven tons of ammunition for each arm provides seventy rounds for each pair of guns, an impressive number of shots even at double rate.

The second variant of the *Kraken*, a missile-support 'Mech, replaces the Ultra autocannons with four LRM-15 launchers in each arm and adds another ten heat sinks. Eight tons of ammunition supply a total of 64 rounds to the four launch systems, more than adequate materiel for most fire-support missions.

Type: Bane
Inner Sphere Designation: **Kraken**
Technology Base: Clan
Tonnage: 100

Equipment		Mass
Internal Structure:		10
Engine:	300 XL	9.5
Walking MP:	3	
Running MP:	5	
Jumping MP:	0	
Heat Sinks:	10 [20]	0
Gyro:		3
Cockpit:		3
Armor Factor:	304	19

	Internal Structure	Armor Value		
Head	3	9		
Center Torso	31	46		
Center Torso (rear)		13		
R/L Torso	21	32		
R/L Torso (rear)		10		
R/L Arm	17	34		
R/L Leg	21	42		

Weapons and Ammo	Location	Critical	Tonnage
AC/2 Ultra	LA	2	5
AC/2 Ultra	LA	2	5
AC/2 Ultra	LA	2	5
AC/2 Ultra	LA	2	5
AC/2 Ultra	LA	2	5
Ammo (Ultra) 90	LT	2	2
AC/2 Ultra	RA	2	5
AC/2 Ultra	RA	2	5
AC/2 Ultra	RA	2	5
AC/2 Ultra	RA	2	5
AC/2 Ultra	RA	2	5
AC/2 Ultra	RA	2	5
Ammo (Ultra) 90	RT	2	2
Machine Gun	RT	1	.25
Machine Gun	RT	1	.25
Machine Gun	RT	1	.25
Machine Gun	RT	1	.25
Ammo (MG) 100	RT	1	.5

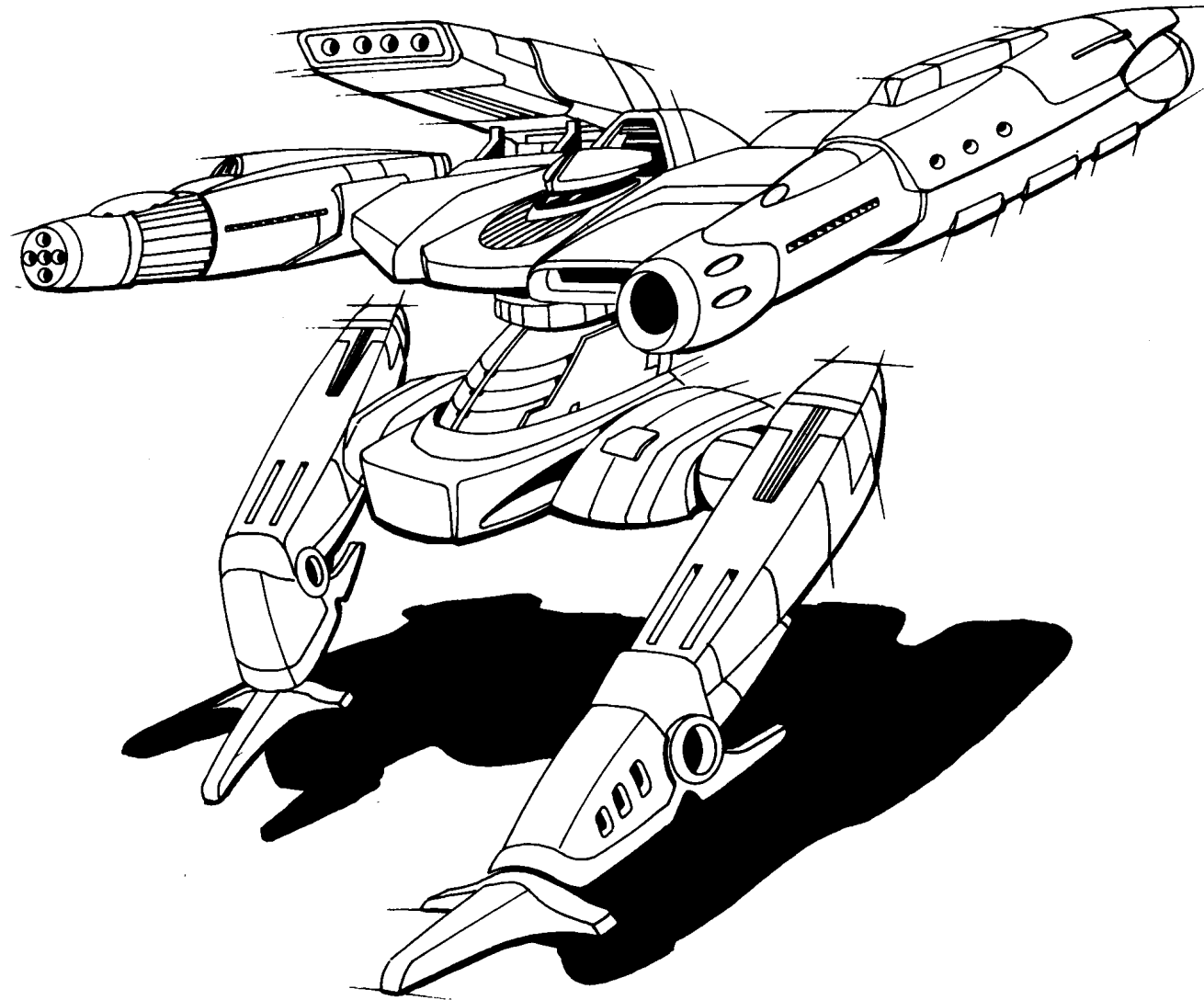



OMNI MECHS

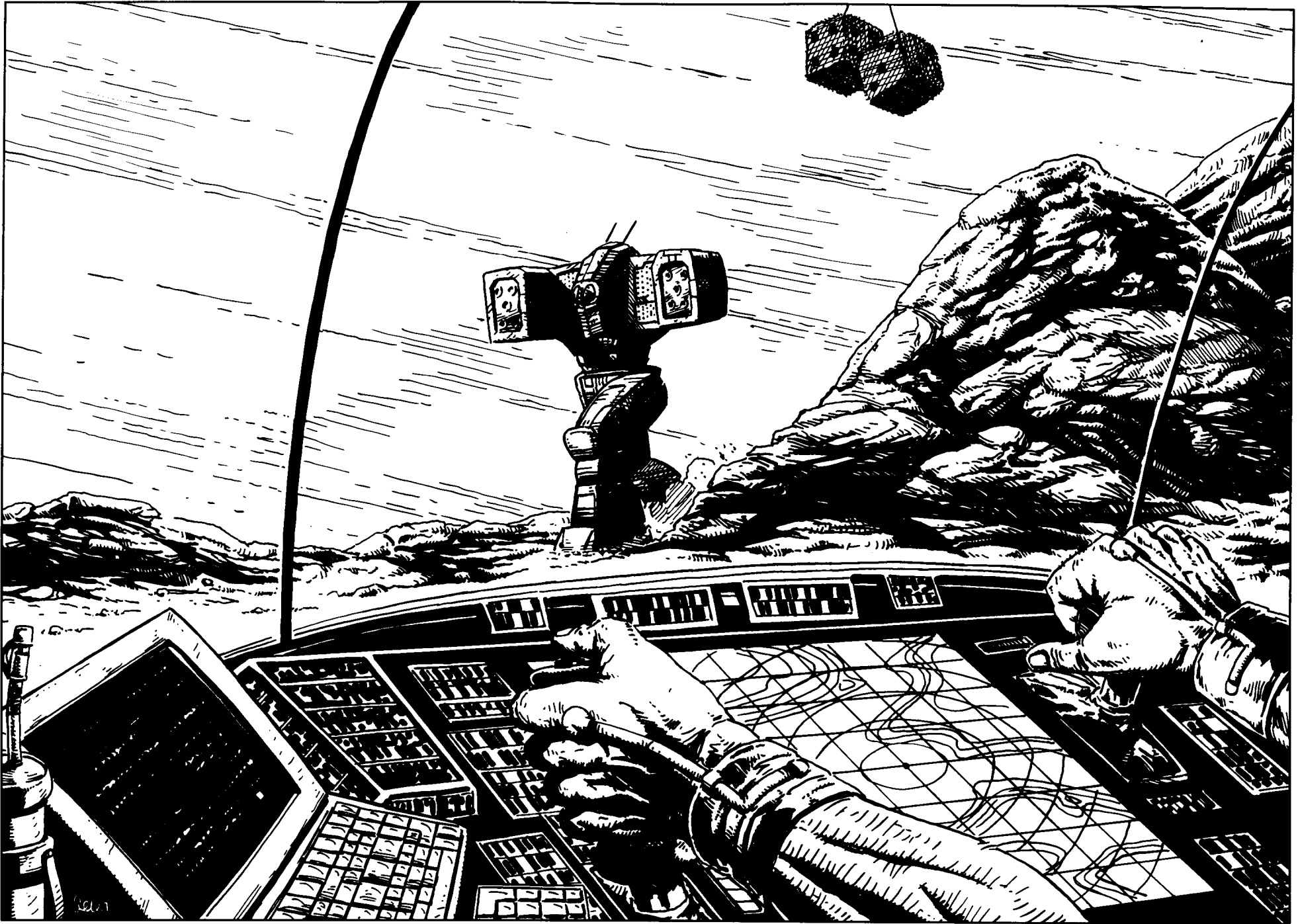

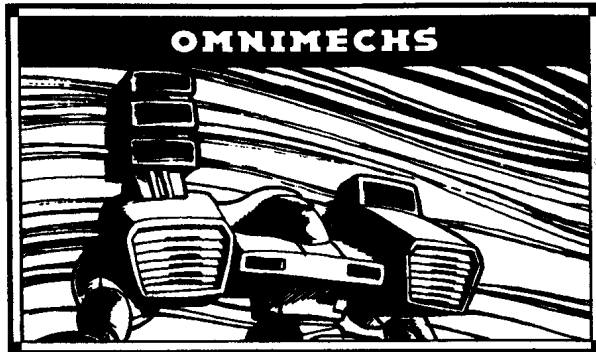

Mass: 40 tons
Chassis: Endo Steel
Power Plant: 360 XL
Cruising Speed: 97.8 kph
Maximum Speed: 151.2 kph
Jump Jets: None
 Jump Capacity: None
Armor: Ferro-Fibrous
Armament:
 6.5 tons pod space available
Manufacturer: Unknown
Communications System: Unknown
Targeting and Tracking System: Unknown

Overview:

The *Phantom* is the result of the Wolf Clan's attempt to push the concept of a fast, medium-sized reconnaissance OmniMech to its limits. The *Phantom* shares many technical details with the *Ferris*, but trades weaponry and armor for speed. The designers hope this trade-off will make the *Phantom* even more elusive than its successful sibling. This OmniMech has a distinctive sleek, curved style. Its outer coating features a special polarizing crystal process that makes it appear indistinct and blurry to any scanning or sensor system. Despite its unique appearance, the *Phantom* faces unfavorable comparison with the *Ferris* because of its lack of weaponry.

Capabilities:

In its standard configuration, the *Phantom* is packed with enough electronics to both shield itself and spot the enemy. When it finds its quarry, it calls to its Star mates to protect it with a rain of artillery fire. In order to make room for all the electronics, the designers pared the weapons down to only a few essentials. The *Phantom's* speed and the pilot's own skill are all he can rely on should he find himself alone against a determined enemy.

Alternate Configuration A has been used in striker units when other OmniMechs are assigned to handle reconnaissance. Its mix of LRMs and lasers is well-balanced, but comparisons with the punch packed by the *Ferris* leaves many warriors unimpressed with this configuration.

Alternate Configuration B is a reconnaissance alternative to the *Phantom's* standard configuration. The two racks of short-range missiles and a medium laser are apparently more popular with pilots than the electronics-heavy standard configuration. This version carries extra armament by dropping all electronics but the active probe.

Alternate Configuration C is new and has been well-received by Clan Wolf pilots. It packs an unprecedented nine small lasers, one medium laser, and a targeting computer to improve accuracy. Though this version lacks effective range weapons, at close range its barrage of laser fire can eat away at any OmniMech. One Inner Sphere warrior commented after losing to a *Phantom C* that it was "like bleeding to death from a hundred paper cuts."

The *Phantom D* is likely to be equally popular. It mounts three medium lasers for middle-distance exchanges, and a small laser and rack of Streak short-range missiles for when the fight goes toe-to-toe.

Deployment:

A *Phantom* would be welcomed with open arms by any Inner Sphere commander, but it faces a doubtful future with the Wolf Clan. Currently, it is used sparingly in only a few clusters. Unless it can somehow break free of the shadow cast by the *Ferris*, it is unlikely to become a major part of the Clan's arsenal.

Type: **Phantom**

Technology Base: Clan OmniMech

Tonnage: 40

Equipment

		Mass
Internal Structure:	Endo Steel	2
Engine:	360 XL	16.5
Walking MP:	9	
Running MP:	14	
Jumping MP:	0	
Heat Sinks:	12 [24]	2
Gyro:		4
Cockpit:		3
Armor Factor:	115	6

	Internal Structure	Armor Value
Head	3	9
Center Torso	12	12
Center Torso (rear)		8
R/L Torso	10	11
R/L Torso (rear)		7
R/L Arm	6	12
R/L Leg	10	13

Weight and Space Allocation

Location	Fixed	Spaces Remaining
Head	1 Ferro-Fibrous	0
Center Torso	1 Endo Steel	1
Right Torso	2 Engine	
	1 Endo Steel	
	1 Ferro-Fibrous	8
Left Torso	2 Engine	
	1 Endo Steel	
	1 Ferro-Fibrous	8
Right Arm	1 Endo Steel	
	1 Ferro-Fibrous	6
Left Arm	1 Endo Steel	
	1 Ferro-Fibrous	6
Right Leg	1 Endo Steel	
	1 Ferro-Fibrous	0
Left Leg	1 Endo Steel	
	1 Ferro-Fibrous	0

Weapons and Ammo Location Critical Tonnage

Primary Weapons Configuration

ER Medium Laser	RA	1	1
ECM Suite	RT	1	1
LRM 5	LA	1	1
Ammo (LRM) 24	LA	1	1
TAG	LT	1	1
ER Small Laser	LT	1	.5
Active Probe	CT	1	1

Alternate Configuration A

ER Small Laser	RA	1	.5
ER Small Laser	RA	1	.5
LRM 5	RT	1	1
Ammo (LRM) 24	RT	1	1
ER Small Laser	LA	1	.5
ER Small Laser	LA	1	.5
LRM 5	LT	1	1
ER Small Laser	LT (R)	1	.5
ER Medium Laser	CT	1	1

Alternate Configuration B

SRM 4	RA	1	1
Ammo (SRM) 25	RA	1	1
ER Small Laser	RT (R)	1	.5
SRM 4	LA	1	1
Ammo (SRM) 25	LA	1	1
Active Probe	LT	1	1
ER Medium Laser	CT	1	1

Alternate Configuration C

ER Small Laser	RA	1	.5
ER Small Laser	RA	1	.5
ER Small Laser	RA	1	.5
ER Small Laser	RA	1	.5
Flamer	RT (R)	1	.5
ER Small Laser	LA	1	.5
ER Small Laser	LA	1	.5
ER Small Laser	LA	1	.5
ER Small Laser	LA	1	.5
ER Medium Laser	LT	1	1
Targeting Computer	CT	1	1

Weapons and Ammo Location Critical Tonnage

Alternate Configuration D

Streak SRM 4	RA	1	2
Ammo (Streak) 25	RA	1	1
ER Small Laser	RA	1	.5
ER Medium Laser	LA	1	1
ER Medium Laser	LA	1	1
ER Medium Laser	CT	1	1

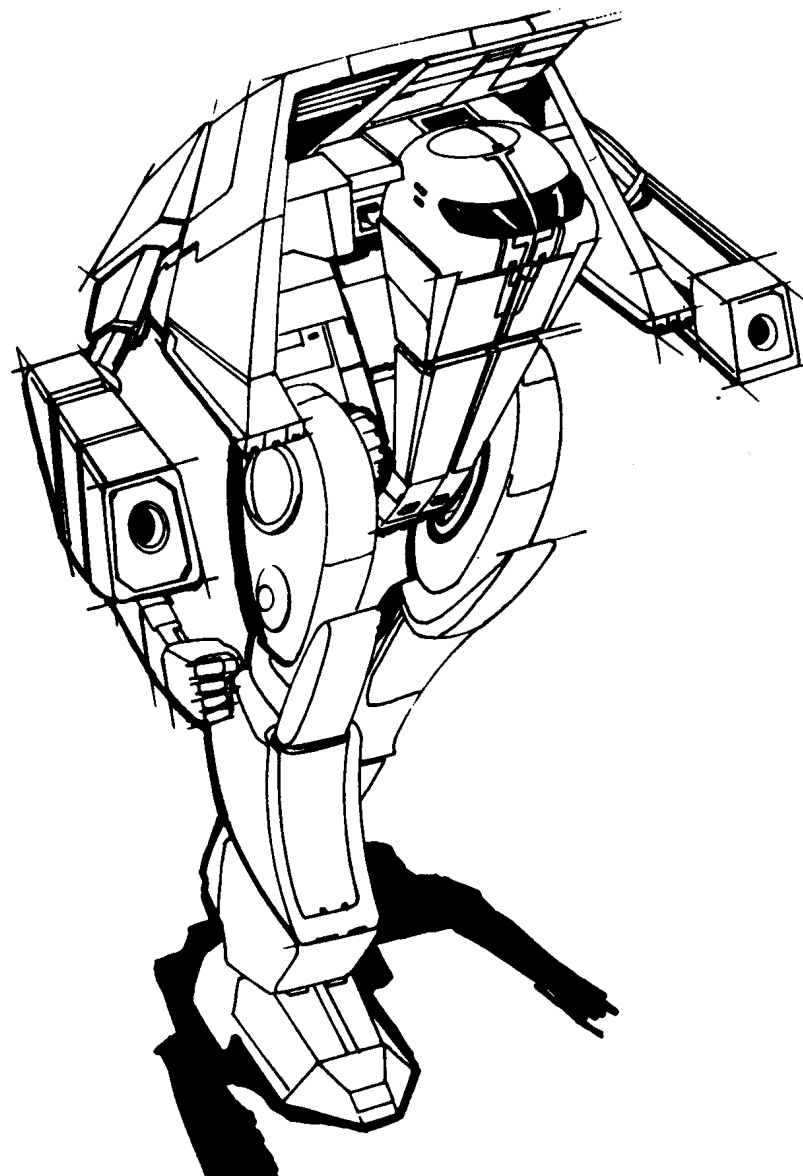

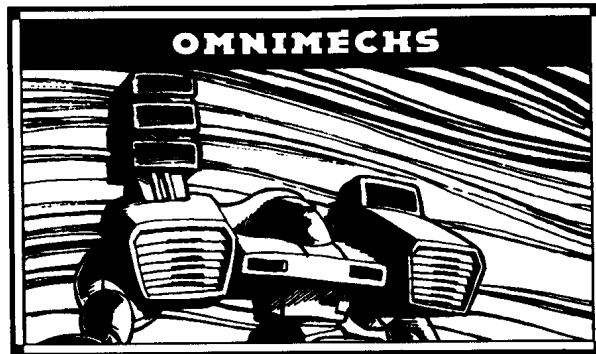

Mass: 40 tons
Chassis: Endo Steel
Power Plant: 240 XL
Cruising Speed: 65.1 kph
Maximum Speed: 96.9 kph
Jump Jets: Unknown
Jump Capacity: 150 meters
Armor: Ferro-Fibrous
Armament:
 15.5 tons pod space available
Manufacturer: Unknown
Communications System: Unknown
Targeting and Tracking System: Unknown

Overview:

Clan Wolf has held a bias against jump-capable OmniMechs for many years, a fact obvious from their OmniMech designs.

The many jump-capable Inner Sphere 'Mechs and warriors skilled in their use have forced Wolf commanders to reevaluate this thinking. On several occasions, most notably against the Kell Hounds, Clan warriors were put at a tactical disadvantage by Inner Sphere warriors' use of their 'Mechs' jumping ability. The Wolf Khans responded by ordering an old test vehicle named the *Pouncer* and other jump-capable designs issued to their warriors. They are using these tests to determine whether jump-capable 'Mechs should be produced in volume to counter Inner Sphere tactics.

Capabilities:

Because the *Pouncer* is, at heart, a major variant of the *Puma*, it shares more than just the *Puma's* general appearance; it also copies the earlier 'Mech's standard configuration. The added jump capability makes the *Pouncer* a feared opponent of light and medium-sized Inner Sphere 'Mechs.

Alternate Configuration A turns the *Pouncer* into an efficient fire-support OmniMech. The LRM-15 racks on the arms deliver heavy long-range damage, and opponents who foolishly close with this variation of the OmniMech are met by a fusillade of four extended range medium lasers.

Alternate Configuration B is also a fire-support OmniMech, using an LRM-10 in its torso and two extended-range large lasers in its arms. For close-in work this *Pouncer* configuration relies on two SRM-4 stacks. A chronic mechanical failure in the missile-feed system of the SRM makes this the least-liked version of the *Pouncer*.

Alternate Configuration C is an interesting marriage of a large autocannon and an array of beam weapons. This version is most likely intended to be part of a team, relying on its Starmates to cover its deficiencies.

Alternate Configuration D presents attackers with a withering array of six medium lasers, their potency enhanced by a targeting computer. Those willing to brave the *Pouncer's* laser fire face two Streak SRM-6 stacks, a deadly accurate weapon. This configuration is understandably a favorite of Wolf test pilots, who feel that it will be a major success in battles where it can close with an enemy and use its weapons and accuracy to best advantage.

Deployment:

Thus far, the *Pouncer* has only appeared in the Ninth Guards Cluster as an experimental design. If the *Pouncer* becomes a standard design in Wolf units in the near future, it will be a feared opponent.

Type: **Pouncer**

Technology Base: Clan OmniMech

Tonnage: 40

Equipment

		Mass
Internal Structure:	Endo Steel	2
Engine:	240 XL	6
Walking MP:	6	
Running MP:	9	
Jumping MP:	5	
Heat Sinks:	12 [24]	2
Gyro:		3
Cockpit:		3
Armor Factor:	115	6
	<i>Internal Structure</i>	<i>Armor Value</i>
Head	3	9
Center Torso	12	12
Center Torso (rear)		8
R/L Torso	10	11
R/L Torso (rear)		7
R/L Arm	6	12
R/L Leg	10	13

Weight and Space Allocation

Location	Fixed	Spaces Remaining
Head	1 Ferro-Fibrous	0
Center Torso	1 Endo Steel 1 Jump Jet	0
Right Torso	2 Engine 1 Endo Steel 2 Ferro-Fibrous 2 Jump Jets Double Heat Sink	3
Left Torso	2 Engine 1 Endo Steel 2 Ferro-Fibrous 2 Jump Jets	3
Right Arm	1 Ferro-Fibrous Double Heat Sink	5
Left Arm	1 Ferro-Fibrous Double Heat Sink	5
Right Leg	2 Endo Steel	0
Left Leg	2 Endo Steel	0

Weapons and Ammo Location Critical Tonnage
Primary Weapons Configuration

Weapons and Ammo	Location	Critical	Tonnage
ER PPC	RA	2	6
Targeting Computer	RT	3	3
ER PPC	LA	2	6
ER Small Laser	LT	1	.5

Alternate Configuration A

Weapons and Ammo	Location	Critical	Tonnage
LRM 15	RA	2	3.5
Ammo (LRM) 16	RA	2	2
ER Medium Laser	RT	1	1
ER Medium Laser	RT	1	1
ER Small Laser	RT (R)	1	.5
LRM 15	LA	2	3.5
Ammo (LRM) 16	LA	2	2
ER Medium Laser	LT	1	1
ER Medium Laser	LT	1	1

Alternate Configuration B

Weapons and Ammo	Location	Critical	Tonnage
ER Large Laser	RA	1	4
SRM 4	RA	1	1
Ammo (SRM) 25	RA	1	1
LRM 10	RT	1	2.5
Ammo (LRM) 12	RT	1	1
ER Large Laser	LA	1	4
SRM 4	LA	1	1
Ammo (SRM) 25	LA	1	1

Alternate Configuration C

Weapons and Ammo	Location	Critical	Tonnage
Ultra AC/10	RA	4	10
Ammo (Ultra) 20	RT	2	2
ER Small Laser	RT	1	.5
ER Medium Laser	LA	1	1
ER Medium Laser	LA	1	1
ER Small Laser	LA	1	.5
ER Small Laser	LT	1	.5

Weapons and Ammo Location Critical Tonnage
Alternate Configuration D

Weapons and Ammo	Location	Critical	Tonnage
ER Medium Laser	RA	1	1
ER Medium Laser	RA	1	1
ER Medium Laser	RA	1	1
Streak SRM 6	RT	2	3
Ammo (Streak) 15	RT	1	1
ER Medium Laser	LA	1	1
ER Medium Laser	LA	1	1
Targeting Computer	LT	2	2
Streak SRM 6	LT	2	3
ER Small Laser	LT (R)	1	.5

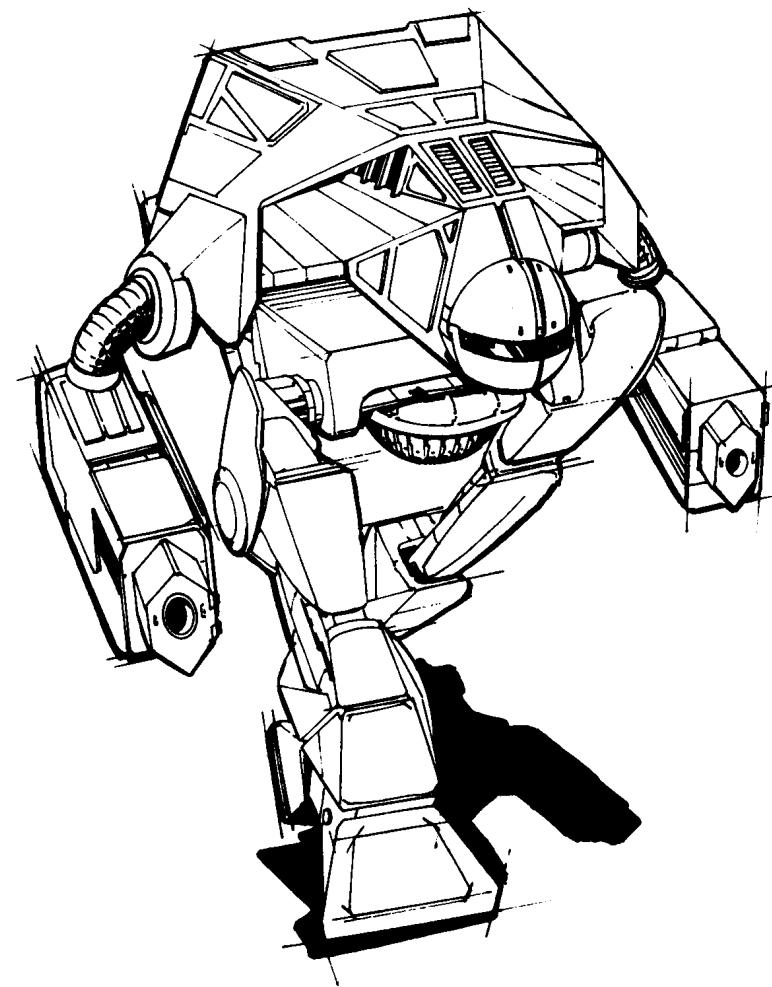

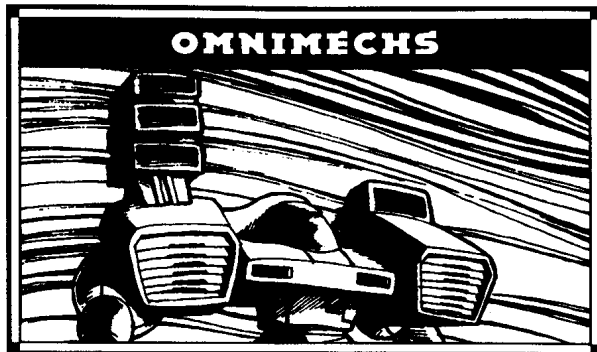

Mass: 65 tons
Chassis: Endo Steel
Power Plant: 390 XL
Cruising Speed: 66 kph
Maximum Speed: 99.5 kph
Jump Jets: None
Jump Capacity: None
Armor: Ferro-Fibrous
Armament:
 17.5 tons pod space available
Manufacturer: Unknown
Communications System: Unknown
Targeting and Tracking System: Unknown

Overview:

The inability of the *Mad Cat* heavy OmniMech to keep up with the rest of its Star mates in running battles was of such concern to Clan Wolf's leaders that they ordered their technicians to develop a new design to supplement and eventually replace it. The *Linebacker*, so named because its unusual hunched-over torso is reminiscent of the hulking players of ancient North American-rules football, was the result of their efforts.

Capabilities:

The *Linebacker's* increased speed means it carries less armament, but those weapons it **does** carry, along with its speed, make it a formidable foe on the battlefield. In its standard configuration, the *Linebacker* punishes threats from a distance. Enemies that do not succumb to its energy weapons or run away from its missile barrage are taken care of by its heavier compatriots. Alternate

Configuration A also delivers long-distance damage, but with a more missile-oriented mix of weapons.

The unusual placement of the Gauss rifle in the right torso of Alternate Configuration B has proven to be a nasty surprise for Inner Sphere MechWarriors accustomed to seeing Gauss rifles only on the arms of OmniMechs. Alternate Configuration C emphasizes rear-firing weapons. Version D was designed as the infighting version of the *Linebacker*, with plenty of SRMs and medium lasers, but it appears to be unpopular with Clan warriors, who feel that the lack of a knock-out weapon leaves the OmniMech exposed to enemy fire for too long.

Deployment:

The *Linebacker* is currently in service with the warriors of Clan Wolf's Gamma Galaxy. Once the final test results and operating data on the *Linebacker* are collected, it is expected to become the Clans' standard-issue heavy OmniMech. Following this transition, the fate of the many operational *Mad Cats* is in question.

Type: Linebacker
Technology Base: Clan OmniMech
Tonnage: 65

Equipment		Mass
Internal Structure:	Endo Steel	3.5
Engine:	390 XL	23
Walking MP:	6	
Running MP:	9	
Jumping MP:	0	
Heat Sinks:	14 [28]	4
Gyro:		4
Cockpit:		3
Armor Factor:	192	10
	<i>Internal Structure</i>	<i>Armor Value</i>
Head	3	9
Center Torso	21	25
Center Torso (rear)		10
R/L Torso	15	22
R/L Torso (rear)		8
R/L Arm	10	20
R/L Leg	15	24

Weight and Space Allocation

Location	Fixed	Spaces Remaining
Head	1 Ferro-Fibrous	0
Center Torso	1 Endo Steel	1
Right Torso	2 Engine 1 Ferro-Fibrous 1 Endo Steel	8
Left Torso	2 Engine 1 Endo Steel 1 Ferro-Fibrous	8
Right Arm	1 Endo Steel 1 Ferro-Fibrous	6
Left Arm	1 Endo Steel 1 Ferro-Fibrous	6
Right Leg	1 Endo Steel 1 Ferro-Fibrous	0
Left Leg	1 Endo Steel 1 Ferro-Fibrous	0

Weapons and Ammo Location Critical Tonnage

<i>Primary Weapons Configuration</i>			
ER PPC	RA	2	6
Streak SRM 4	RT	1	2
Ammo (Streak) 25	RT	1	1
ER PPC	LA	2	6
LRM 5	LT	1	1
Ammo (LRM) 24	LT	1	1
ER Small Laser	RT (R)	1	.5

Alternate Configuration A

ER Large Laser	RA	1	4
ER Medium Laser	RT	1	1
LRM 5	RT	1	1
Ammo (LRM) 24	RT	1	1
ER Medium Laser	RT	1	1
ER Large Laser	LA	1	4
LRM 15	LT	2	3.5
Ammo (LRM) 16	LT	2	2

Weapons and Ammo Location Critical Tonnage

Alternate Configuration B

ER Medium Laser	RA	1	1
Gauss Rifle	RT	6	12
Ammo (Gauss) 16	RT	2	2
ER Medium Laser	LA	1	1
ER Medium Laser	LA	1	1
ER Small Laser	LT	1	.5

Alternate Configuration C

Ultra AC/5	RA	3	7
Ammo (Ultra) 20	RA	1	1
Machine Gun	RT	1	.25
Machine Gun	RT (R)	1	.25
Ammo (MG) 100	RT	1	.5
Flamer	RT (R)	1	.5
ER Medium Laser	LA	1	1
ER Large Laser	LA	1	4
ER Medium Laser	LT	1	1
ER Medium Laser	LT	1	1
ER Medium Laser	LT (R)	1	1

Alternate Configuration D

Streak SRM 6	RA	2	3
Streak SRM 6	RA	2	3
Ammo (Streak) 15	RA	1	1
ER Medium Laser	RT	1	1
Streak SRM 6	LA	2	3
Streak SRM 6	LA	2	3
Ammo (Streak) 30	LA	2	2
ER Medium Laser	LT	1	1
ER Small Laser	LT (R)	1	.5

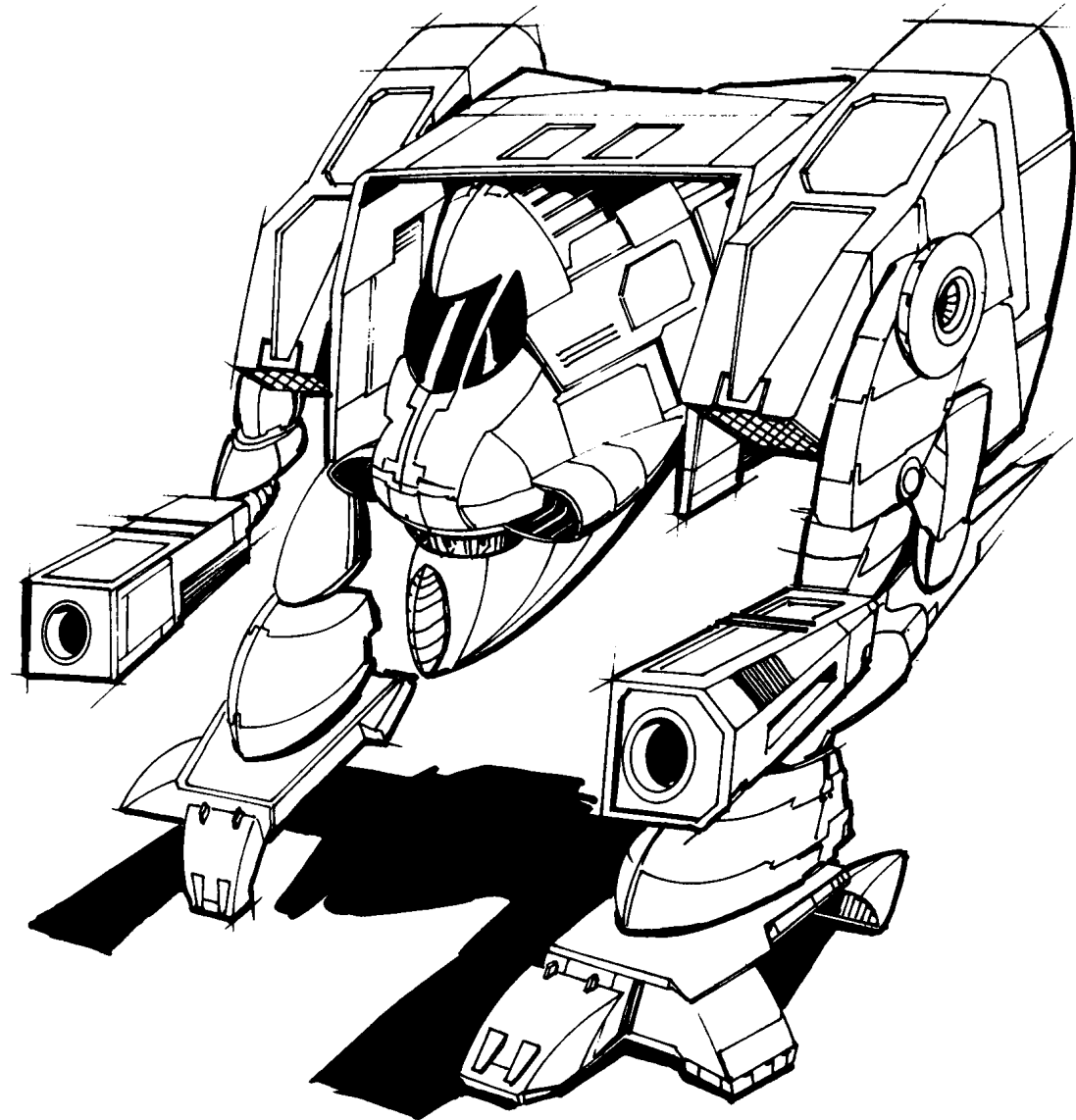

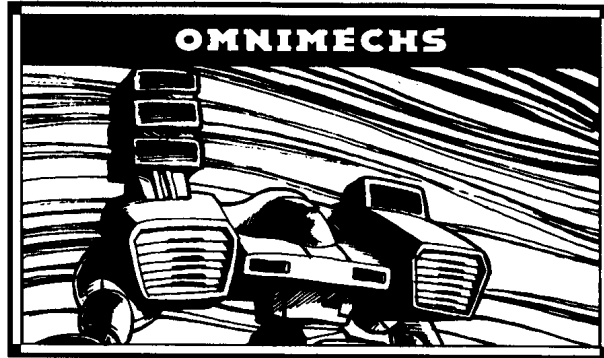

Mass: 80 tons
Chassis: Endo Steel
Power Plant: 400 XL
Cruising Speed: 54 kph
Maximum Speed: 86.4 kph
Jump Jets: None
Jump Capacity: None
Armor: Standard
Armament:
 7.5 tons pod space available
Manufacturer: Unknown
Communications System: Unknown
Targeting and Tracking System: Unknown

Overview:

Clan Wolf military boasts one of the few Omnimechs designed solely to take advantage of the Arrow IV artillery missile system. The *Naga* was developed more than a hundred years ago from the *Woodsmen*, the precursor to today's *Man O' War*. Designers extended the *Woodsmen's* torso to encompass two Arrow missile systems. The wide, sweeping curve of the new torso so reminded warriors of a cobra hood that they nicknamed the new Omnimech *Naga*, for a particularly venomous cobra from ancient myth.

Capabilities:

The *Naga* was developed to deliver a sustained barrage of artillery missiles. The Omnimech's standard configuration best fulfills this mission by carrying six tons of missiles, assuring that it will be able to support its

Cluster mates through all but the longest battle. However, the standard-configuration *Naga* is the most defenseless in a short-range battle, with only three small lasers to ward off any enemy that manages to close.

All the alternate configurations give the *Naga* pilot more short-range protection. Alternate Configuration A sacrifices one ton of missiles to gain two medium-range lasers and a short-range laser. Alternate Configuration B carries only four tons of missiles, but packs one small and three medium lasers. Alternate Configuration C uses a six-stack of short-range missiles as its primary weapon against the approach of fast-moving enemies. Alternate Configuration D is similar to C, but uses only an SRM-4 missile system and adds a medium laser to its small laser.

Alternate Configuration B is the version of the *Naga* most favored among pilots, because they feel it gives them the best protection. However, most *Naga* pilots are allowed to take only the standard configuration into battle.

Deployment:

Nagas appear almost exclusively in Wolf Galaxy artillery stars and seldom see action because of the nature of the bidding process. However, individual *Nagas* may accompany frontline Omnimechs into battle, and a few saw combat during the Wolf invasion of the Free Rasalhague Republic.

Because the *Naga* serves mainly as artillery support, most warriors shun it, leaving it to aging veterans or freebirth warriors. This disdain is one of the reasons *Naga* pilots are seldom allowed to outfit their Omnimechs as they want, forced to pilot the near-defenseless standard version. Piloting a *Naga* brings no honor to the warrior, and reconfiguring an honorless weapon goes beyond a waste of time and materiel. Some reports state that Clan Wolf warriors at times deliberately left their accompanying *Nagas* unprotected to face Inner Sphere 'Mechs alone. It is a testament to the skill of the MechWarriors piloting the inferior *Nagas* that most survived those encounters.

Type: Naga

Technology Base: Clan OmniMech

Tonnage: 80

Equipment

		Mass
Internal Structure:	Endo Steel	4.0
Engine:	400 XL	26.5
Walking MP:	5	
Running MP:	8	
Jumping MP:	0	
Heat Sinks:	12 [24]	2
Gyro:		4
Cockpit:		3
Armor Factor:	144	9

	Internal Structure	Armor Value
Head	3	9
Center Torso	25	17
Center Torso (rear)		10
R/L Torso	17	15
R/L Torso (rear)		9
R/L Arm	13	14
R/L Leg	17	16

Weight and Space Allocation

Location	Fixed	Spaces Remaining
Head		1
Center Torso	1 Endo Steel	1
Right Torso	1 Endo Steel 2 Engine Arrow IV System	7
Left Torso	1 Endo Steel 2 Engine Arrow IV System	7
Right Arm	Arrow IV System	0
Left Arm	Arrow IV System	0
Right Leg	2 Endo Steel	0
Left Leg	2 Endo Steel	0

Weapons and Ammo Location Critical Tonnage

Primary Weapons Configuration

Ammo (Arrow IV) 15	RT	3	3
ER Small Laser	RT	1	.5
Ammo (Arrow IV) 15	LT	3	3
ER Small Laser	LT	1	.5
ER Small Laser	CT	1	.5

Alternate Configuration A

Ammo (Arrow IV) 10	RT	2	2
ER Medium Laser	RT	1	1
Ammo (Arrow IV) 15	LT	3	3
ER Small Laser	LT	1	.5
ER Medium Laser	CT	1	1

Alternate Configuration B

Ammo (Arrow IV) 10	RT	2	2
ER Medium Laser	RT	1	1
ER Small Laser	RT	1	.5
Ammo (Arrow IV) 10	LT	2	2
ER Medium Laser	LT	1	1
ER Medium Laser	CT	1	1

Alternate Configuration C

Ammo (Arrow IV) 10	RT	2	2
ER Small Laser	RT	1	.5
Ammo (Arrow IV) 10	LT	2	2
SRM 6	LT	1	1.5
Ammo (SRM) 15	LT	1	1
ER Small Laser	CT	1	.5

Alternate Configuration D

Ammo (Arrow IV) 10	RT	2	2
ER Medium Laser	RT	1	1
Ammo (Arrow IV) 10	LT	2	2
SRM 4	LT	1	1
Ammo (SRM) 25	LT	1	1
ER Small Laser	CT	1	.5

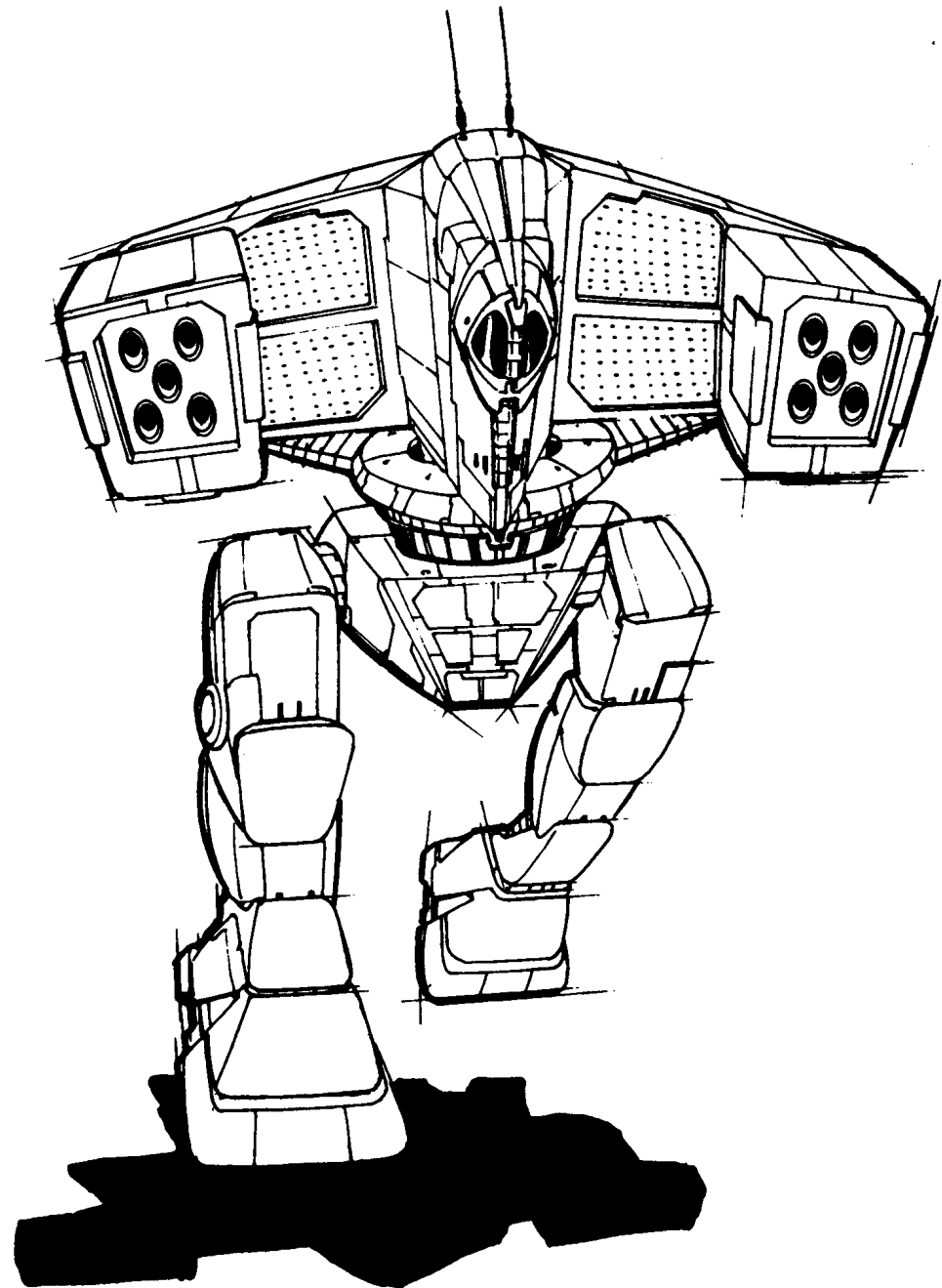



AEROSPACE SUPERIORITY

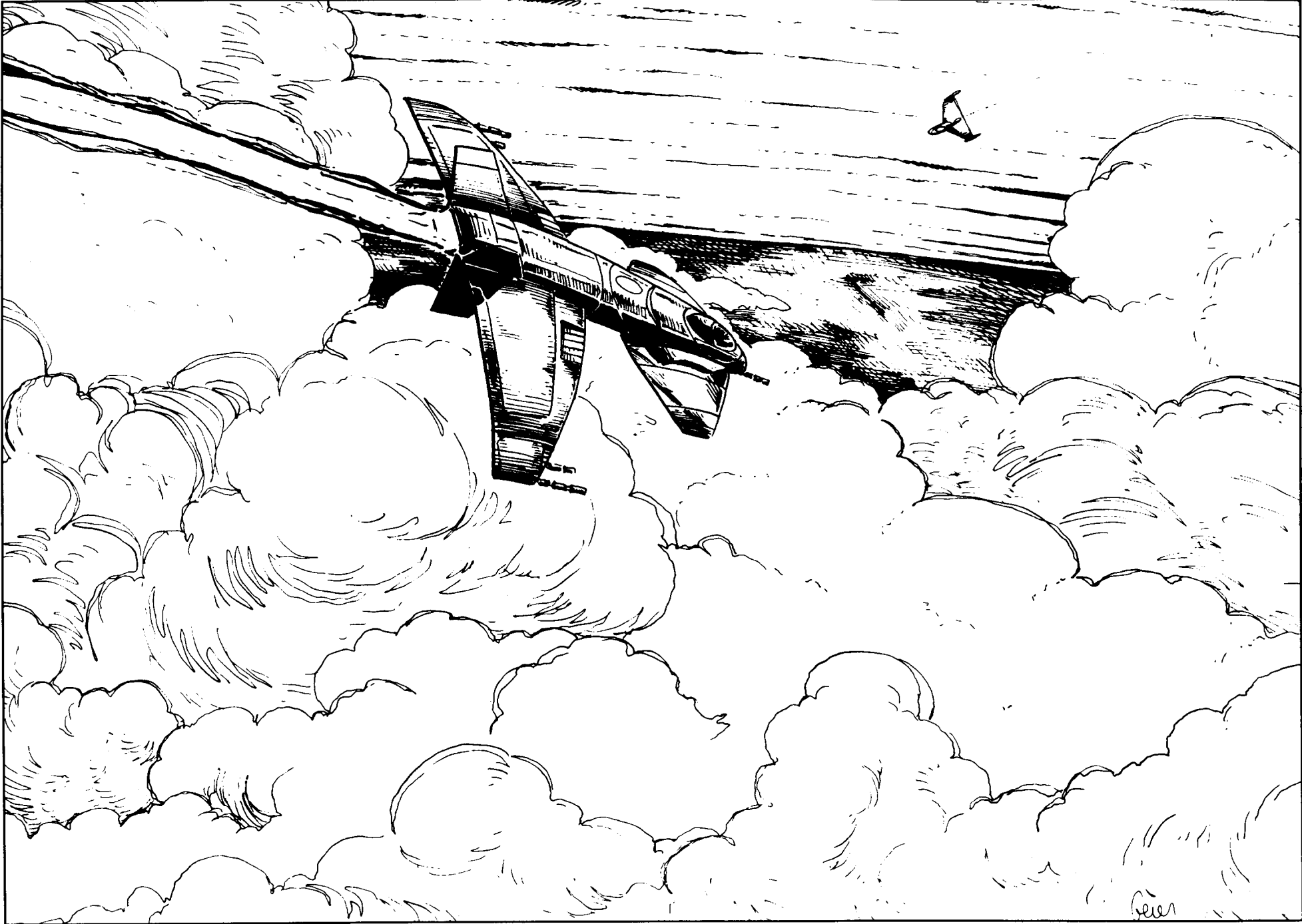

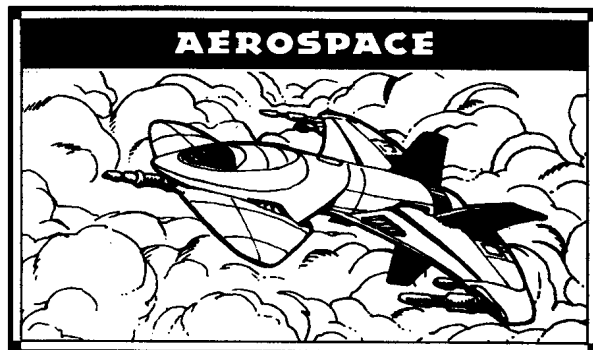

Mass: 20 tons

Frame: Unknown

Engine: 220 XL

Armor: Ferro-Aluminum

Armament:

4.5 tons pod space available

Manufacturer: Unknown

Communications System: Unknown

Targeting and Tracking System: Unknown

Overview:

The *Bashkir* is the lightest and fastest OmniFighter in service with the Clans. Its small size means that its armor protection, payload, and endurance are severely limited. However, its high speed makes it ideal for reconnaissance missions and swift strikes against unprepared targets.

Capabilities:

The *Bashkir* is swift and super-maneuverable, which would normally make it an ideal atmospheric dog-fighter. The limited fuel supply on board each fighter reduces its endurance in low atmosphere, however, which makes encounters with the *Bashkir* more likely in high atmosphere or in space where they can coast, using their few tons of fuel to change vector. Although the method of construction enables the fighter to make successful high-G maneuvers, the *Bashkir* is fragile because of its small size. One or two well-placed shots can render the fighter helpless or even destroy it.

The primary *Bashkir* configuration, seen most frequently with the Steel Viper Clan, mounts an extended range small laser in the nose, directly above a Streak SRM-2. An extended range medium laser on each wing-tip provides only limited ability to project fire. Best suited to close-in dogfighting, this model is usually assigned to a first-response space-superiority role, performing similarly to the Inner Sphere's *Sparrowhawk*. Although able to inflict only light damage on most targets, the *Bashkir* can usually delay enemy attackers until heavier OmniFighters arrive in the battle area.

The A configuration has a more restricted firing arc than the primary because all its weapons are mounted in the nose. The SRM-2 is upgraded to an SRM-6, and the small laser to a medium pulse, giving the fighter a lower damage potential, but a better "scatter" effect for scouring the surface of the target. The *Bashkir A* uses a ballistic weapon as its primary armament. This limits its battlefield endurance, but gives it a fair punch in a dogfight.

The *Bashkir B* has a longer reach than any other variant, mounting an LRM-5 under each wing. The plentiful supply of ammunition for these missile launchers means that the *Bashkir B* is likely to run out of fuel before it runs out of ammunition. This variant is often assigned close to planetary bodies, using the gravity well to maneuver, thus conserving fuel. Some *Bashkir B* fighters operate in conjunction with a *Sabutai B*, having had all their missile warheads programmed to home on the Narc beacons delivered by the heavier fighter.

The C variant, despite its limited armament, is the primary ground attack version. All its weapons are also mounted in the nose, restricting its firing arc, but making it easier for the pilot to bring all weapons to bear against a single target. It has two extended range lasers, one large and one small, which give the craft a good strafing ability and allow it to engage airborne/spaceborne targets, while limiting the fighter's exposure to return fire.

Deployment:

Though originally developed by Clan Snow Raven, small numbers of *Bashkir* fighters appear with all the

Clans. The Smoke Jaguars have the largest single contingent among all the Clans in the Inner Sphere. Most variants seen are used for interception or patrol missions. Although ground-attack and transporter versions do exist, they are a rare sight. Such variants are usually configured on the orders of Cluster or Galaxy commanders, not by pilot choice.

Type: *Bashkir*

Technology Base: Clan OmniFighter

Tonnage: 20

Equipment		Mass
Engine:	220 XL	5
Thrust	13	
Overthrust	20	
Structural Integrity:	13	
Heat Sinks:	11 [22]	1
Fuel:	45	3
Cockpit:		3
Armor Factor:	67 + 10	3.5
	<i>Armor Value</i>	<i>Free Space</i>
Cockpit	10 + 0	—
Nose	14	6
Wings	12/12	4/4
Fuselage	17	2 (aft)
Engine	12	—

Weapons and Ammo	Location	Tonnage
<i>Primary Weapons Configuration</i>		
ER Small Laser	Nose	.5
Streak SRM 2	Nose	1
Ammo (Streak) 50	Nose	1
ER Medium Laser	RW	1
ER Medium Laser	LW	1
<i>Alternate Configuration A</i>		
SRM 6	Nose	1.5
Ammo (SRM) 15	Nose	1
Medium Pulse Laser	Nose	2

Weapons and Ammo

Alternate Configuration B

	Location	Tonnage
ER Small Laser	Nose	.5
LRM 5	RW	1
Ammo (LRM) 25	RW	1
LRM 5	LW	1
Ammo (LRM) 25	LW	1

Alternate Configuration C

ER Large Laser	Nose	4
ER Small Laser	Nose	.5

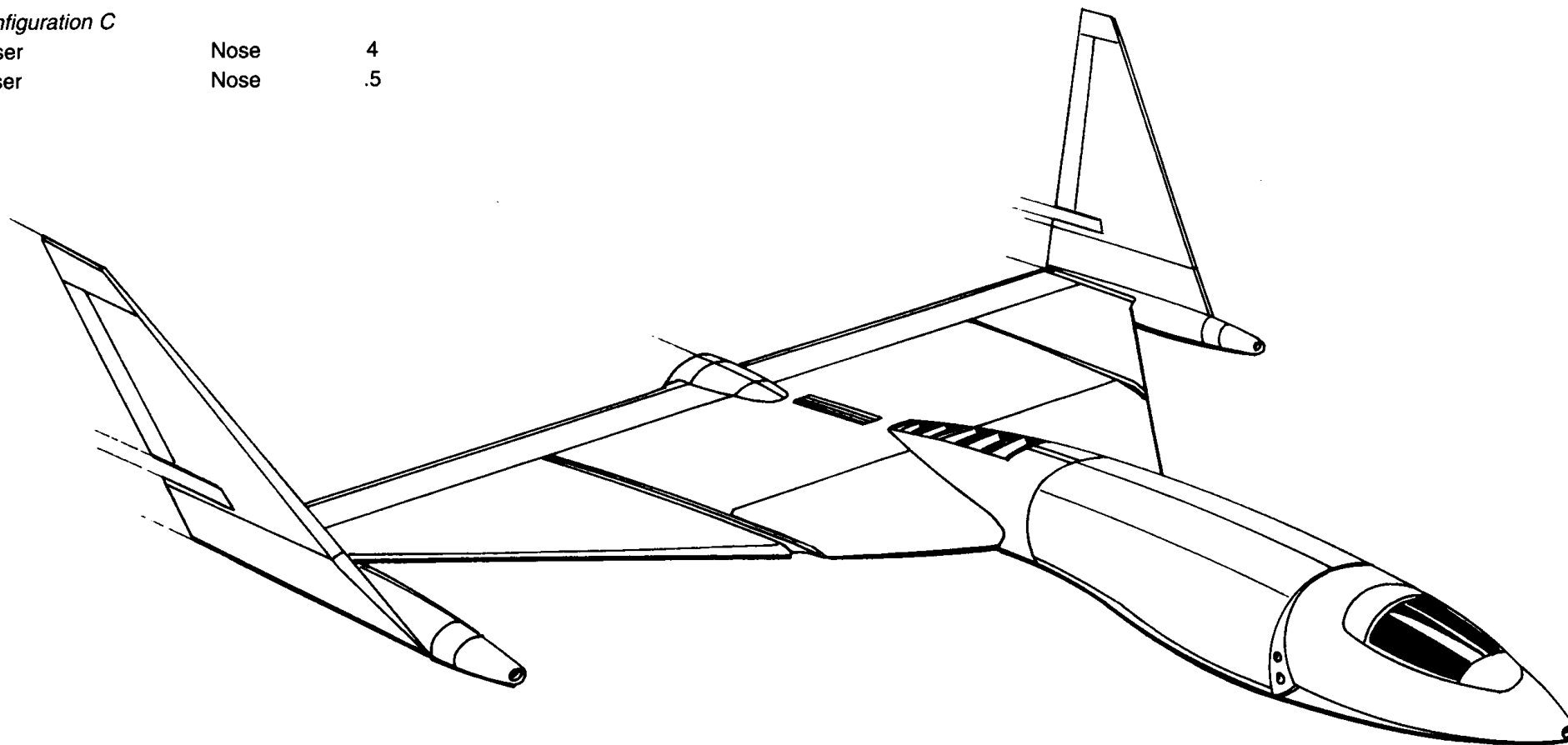



Mass: 30 tons
Frame: Unknown
Engine: 360 XL
Armor: Ferro-Aluminum
Armament:
 3 tons pod space available
Manufacturer: Unknown
Communications System: Unknown
Targeting and Tracking System: Unknown

Overview:

Although the *Vandal* is the most maneuverable fighter in use among the Clans, it is the least versatile, resulting in many Clan commanders deciding not to use it. In most such situations, a fighter would be either withdrawn to rear-echelon units or else scrapped. However, all the Clans maintain a few *Vandals* for high-speed reconnaissance missions, and the current conflict with the states of the Inner Sphere has led to the use of a number of *Vandals* for high-speed strikes.

Capabilities:

The primary *Vandal* is a high-speed reconnaissance vehicle. Often acting as the eyes of a unit, this fighter carries a Beagle active probe, giving it a good chance of detecting and identifying ground targets. Though the pair of small lasers mounted in the nose are doubtless intended for the pilot's defense, some pilots have tried to use them against targets on low-level passes, hoping to gain some glory from this poor assignment. The primary *Vandal* also carries an extra ton of fuel, which gives it the best endurance of any of the variants.

The A variant carries a medium pulse laser in the nose. It also mounts an extended range small laser on a pylon above each wing because the *Vandal A* is most often used to deliver a massive bomb load onto a target. Approaching its target at supersonic speeds and at treetop height, this variant usually carries out missions against installations or command centers, delivering its payload before the defenders have time to react.

The B variant mounts a plethora of extended range small lasers. Two are mounted in each wing, and another pair directly below the cockpit. Because of the efficiency of its weapons, this version is most used for strafing. Rather than carry bombs, the *Vandal B* makes a pass against its target at high speed, then returns from a completely different direction to attack the same target, hopefully keeping the target's defenders watching all points of the compass, minimizing return fire.

The *Vandal C* is armed with three extended-range medium lasers, set into a triangular mount in the craft's nose. Though these weapons provide good coverage to the front of the fighter, this variant has no protection against flank or rear attacks. The weapons mix of the C version makes it usable in both ground-support and air-superiority missions, but its limited fuel reserve keeps the fighter close to its base or carrier.

Deployment:

The *Vandal* is usually assigned only to freeborn warriors. The threat of being issued a *Vandal* is usually enough to keep the most disobedient pilot in line, as there is little chance of honor. Like the *Naga* OmniMech of Clan Wolf, the *Vandal* is not designed as a front-line combat vehicle, but to provide reconnaissance data to the 'Mechs and fighters in its Cluster.

Type: Vandal
Technology Base: Clan OmniFighter
Tonnage: 30

Equipment		Mass
Engine:	360 XL	16.5
Thrust	14	
Overthrust	21	
Structural Integrity:	14	
Heat Sinks:	10 [20]	0
Fuel:	45	3
Cockpit:		3
Armor Factor:	86 + 10	4.5
	<i>Armor Value</i>	<i>Free Space</i>
Cockpit	10 + 6	—
Nose	20	6
Wings	15/15	4/4
Fuselage	18	2 (aft)
Engine	12	—

Weapons and Ammo	Location	Tonnage
<i>Primary Weapons Configuration</i>		
ER Small Laser	Nose	.5
ER Small Laser	Nose	.5
Active Probe	Nose	1
Fuel (15)	—	1
<i>Alternate Configuration A</i>		
Medium Pulse Laser	Nose	2
ER Small Laser	RW	.5
ER Small Laser	LW	.5

Alternate Configuration B

ER Small Laser	Nose	.5
ER Small Laser	Nose	.5
ER Small Laser	RW	.5
ER Small Laser	RW	.5
ER Small Laser	LW	.5
ER Small Laser	LW	.5

Alternate Configuration C

ER Medium Laser	Nose	1
ER Medium Laser	Nose	1
ER Medium Laser	Nose	1

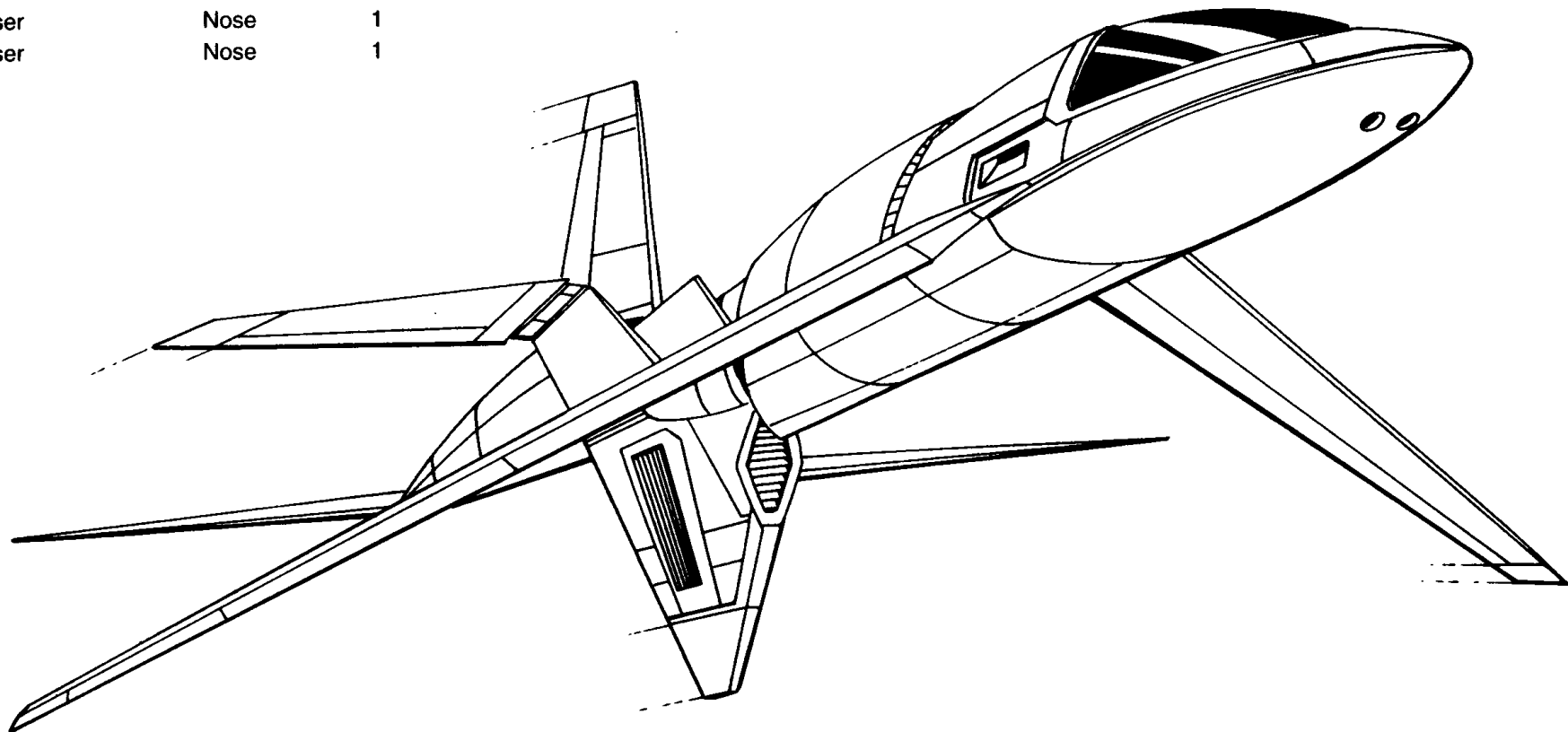

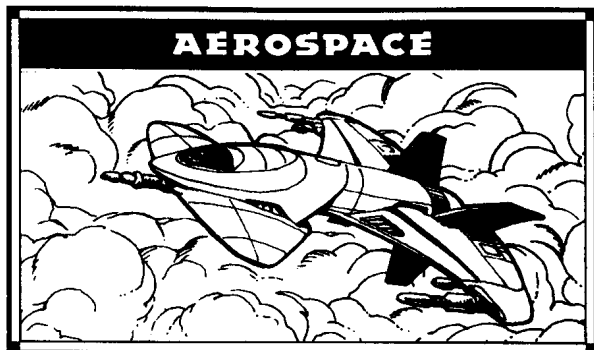

Mass: 35 tons
Frame: Unknown
Engine: 280 XL
Armor: Ferro-Aluminum
Armament:
 14 tons pod space available
Manufacturer: Unknown
Communications System: Unknown
Targeting and Tracking System: Unknown

Overview:

The *Avar* is an older design that has only average maneuverability for its weight, and only moderate amounts of armor, though it is reasonably armed with 14 tons of pod space. It is a solid design that offers few surprises, which is one reason it is not popular with its unpredictable Clan pilots. Commanders, however, do like the design, for it is a workhorse that usually gets the job done. That is, if its pilots remember that the *Avar* is only a light fighter.

Capabilities:

The primary *Avar* configuration carries a nose-mounted Streak SRM-6. Though ammunition for this weapon is limited to one ton, because of the efficiency of the Streak system, that is usually sufficient for a single battle. Three medium pulse lasers are also present, one in the nose and one in each wing. The "burst" of fire from these weapons considerably increases the chance of a hit, allowing the fighter to engage targets that might otherwise be distant or too awkward to hit.

Despite the "accuracy" of the pulse lasers, the main ranged weapon of the primary *Avar* is the large laser mounted directly below the missile rack in the nose.

The A variant also carries a missile system in the nose. In this case, however, it is an LRM-20 system, which is connected to an Artemis/ computer. Two extended range medium lasers are mounted in each wing, providing moderate ranged-attack ability. Another medium laser, this time pulsed, is mounted in the rear of the craft.

The *Avar B* configuration is armed only with energy weapons, and thus is an excellent vehicle for strafing. Twin large pulse lasers are mounted in the fuselage, backed up by an ER medium laser mounted on each wing-tip. Though lacking the accuracy or the range of their larger cousins, these medium lasers allow the *Avar* to produce a devastating volley of fire at close range.

The *Avar C* can also deliver a devastating volley of fire, this time from twin SRM-6 packs in each wing. Rather than fitting the Artemis to each launcher, the designers opted to fit a Narc beacon system, which restricts the number of targets against which the homing warheads of the SRMs can be used. Thus, this *Avar*, like many others, carries a back-up energy weapon system, a medium laser on each wing-tip and in the nose to supplement the missile launchers.

Deployment:

It is only through the requests of a handful of commanders that this design is still in service. Unlike the *Vandal*, which remains in service thanks to its highly specialized nature, the *Avar's* very lack of any specialty is what has saved it from being mothballed. The combination of moderate speed and a relatively large amount of pod space gives commanders enormous flexibility in using this fighter.

Type: *Avar*
Technology Base: Clan OmniFighter
Tonnage: 35

Equipment		Mass
Engine:	280 XL	8
Thrust	10	
Overthrust	15	
Structural Integrity:	10	
Heat Sinks:	10 [20]	0
Fuel:	45	3
Cockpit:		3
Armor Factor:	134 + 10	7
	Armor Value	Free Space
Cockpit	10 + 6	—
Nose	30	6
Wings	24/24	4/4
Fuselage	30	2 (aft)
Engine	20	—

Weapons and Ammo	Location	Tonnage
<i>Primary Weapons Configuration</i>		
Streak SRM 6	Nose	3
Ammo (Streak) 15	Nose	1
Medium Pulse Laser	Nose	2
ER Large Laser	Nose	4
Medium Pulse Laser	RW	2
Medium Pulse Laser	LW	2
<i>Alternate Configuration A</i>		
LRM 20	Nose	5
Ammo (LRM) 12	Nose	2
Artemis IV FCS	Nose	1
ER Medium Laser	RW	1
ER Medium Laser	RW	1
ER Medium Laser	LW	1
ER Medium Laser	LW	1
Medium Pulse Laser	Aft	2

Weapons and Ammo **Location** **Tonnage**

Alternate Configuration B

Large Pulse Laser	Nose	6
Large Pulse Laser	Nose	6
ER Medium Laser	RW	1
ER Medium Laser	LW	1

Alternate Configuration C

Narc Missile Beacon	Nose	2
Ammo (Narc) 6	Nose	1
ER Medium Laser	Nose	1
SRM 6	RW	1.5
SRM 6	RW	1.5
ER Medium Laser	RW	1
SRM 6	LW	1.5
SRM 6	LW	1.5
ER Medium Laser	LW	1
Ammo (SRM) 30	Nose	2

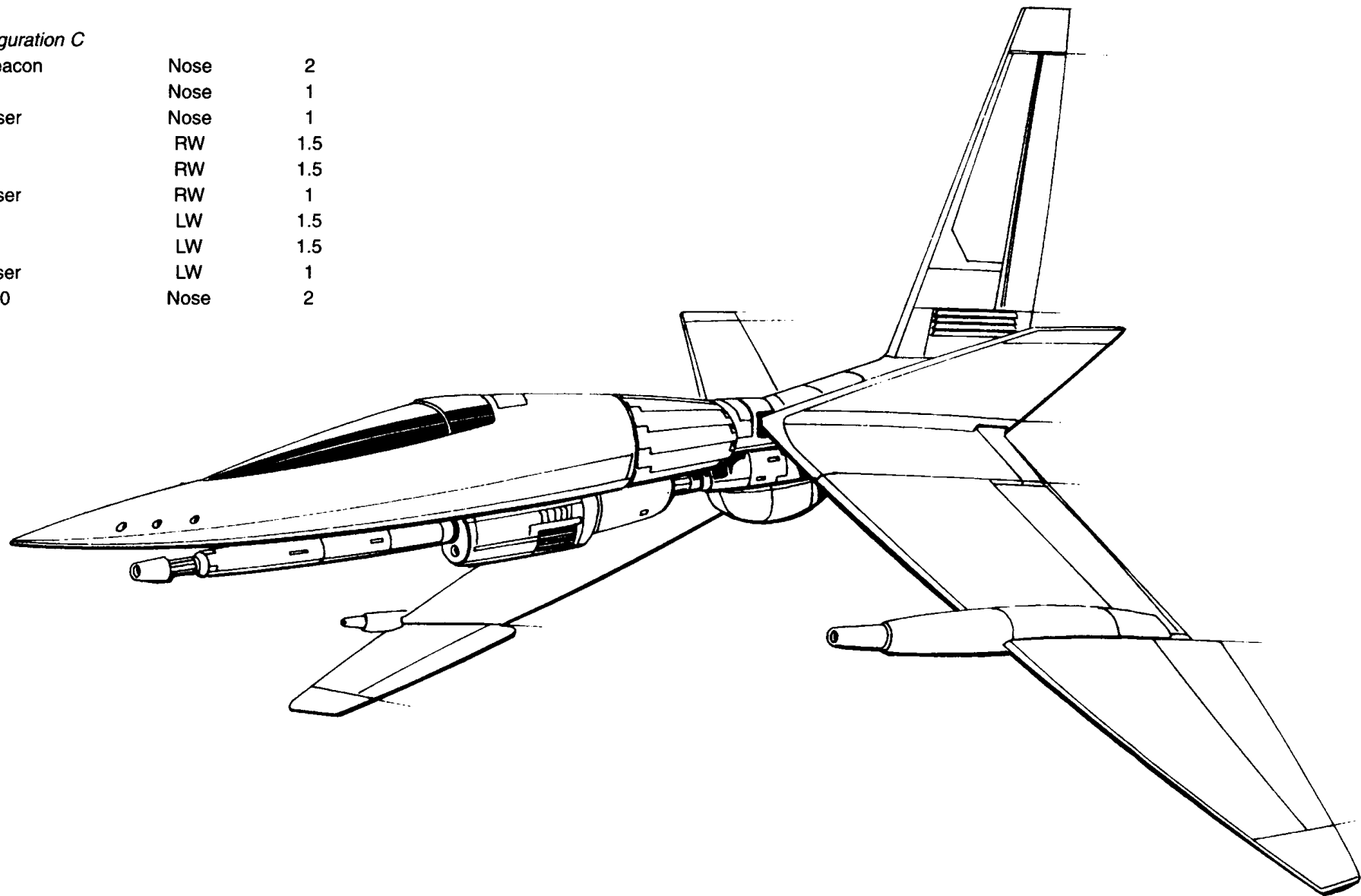

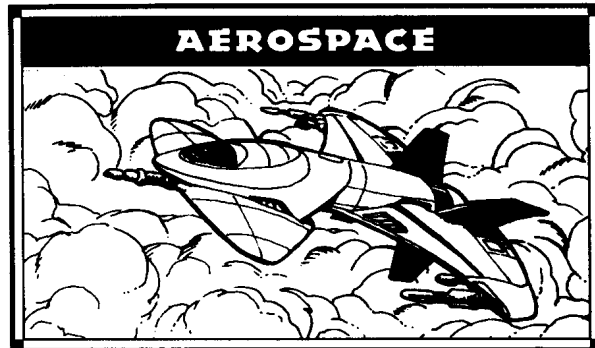

Mass: 40 tons
Frame: Unknown
Engine: 280 XL
Armor: Ferro-Aluminum
Armament:
 18 tons pod space available
Manufacturer: Unknown
Communications System: Unknown
Targeting and Tracking System: Unknown

Overview:

Developed by Clan Steel Viper, the *Batu* fits their standard attack pattern for both ground and air fighting, of swift, deadly strikes. Clans Wolf, Jade Falcon, and Fire Mandrill have captured a number of *Batu* over the years, along with pilots and technicians, effectively redistributing the design where it was most needed at the time.

Capabilities:

The 40-ton *Batu* was designed as a highly maneuverable weapons platform, for primary use as an interceptor. Its high thrust rating enables it to catch all but the fastest enemy craft. The specifications for the design required a considerable weapons payload, which resulted in a first-response fighter that is slower than most, but whose firepower can easily tip the scales of airborne skirmishes. The *Batu's* agility gives it an edge over slightly heavier fighters, but the fighter's limited fuel supply drastically reduces its staying power.

The primary variant is well suited to its intended dog-fighting role, as it carries enough weaponry to dis-

concert heavier fighters. The main weapon is an extended range large laser, mounted in a pod directly below the nose. Under/over wing-tip mounted medium pulse lasers provide additional accurate and withering fire. An extended range medium laser wards the rear of the craft. To increase accuracy, a sophisticated targeting computer replaces the standard fire-control system, and when combined with the pulse lasers, an enemy pilot faces deadly accurate fire.

The A variant comes complete with a state-of-the-art ER PPC built into the nose cone, providing a long-range punch. The rest of the weaponry is configured for close-in fighting, with four old-fashioned SRM-6 launchers, two in each wing. To improve the effectiveness of the SRM system, a Narc beacon system is installed in the nose of the craft.

The B variant was designed as a strafing vehicle, but is equally well-suited to the role of interceptor. To achieve excellence as a strafing vehicle, the designers gave it pulse laser weaponry rather than a larger quantity of the more compact extended range type. Alone, the pulse lasers are impressively accurate, but when slaved to a sophisticated targeting computer, they make this craft a feared sight to any 'Mech pilot. The craft carries seven medium pulse lasers, arranged in a triangular nose mount, and two under/over wing-tip mounts (like the primary). A single extended range medium laser covers the rear to discourage anyone from tailing while the pilot is vulnerable on his strafing run.

The C variant is unusual for its lack of heat dissipation problems, allowing it to fire all its nose and wing weaponry without suffering adverse effects. This is thanks to the mounting of a Gauss rifle as the primary assault weapon. This gives the *Batu C* the ability to inflict massive damage over long range, but ammunition for the nose-mounted cannon is severely limited. The fighter is often reduced to its secondary weaponry, which consists of two ER medium lasers in the nose, and two ER small lasers in the standard wing-tip mounts. One ER medium laser firing into the rear arc completes the secondary weaponry, which is sufficient when acting as back-up for the Gauss, but does little to discourage attacks when the Gauss rifle's ammunition bins are empty.

Deployment:

Batu are found in a number of Clans, used primarily as a carrier for surface-launched interceptors, although a number are deployed as multi-role aircraft. Most of the *Batu* in the Inner Sphere have been encountered in the Lyran Commonwealth portion of the Federated Commonwealth, and in the Free Rasalhague Republic, though the Nova Cats and Smoke Jaguars have fielded a few in their Kurita theater of operations.

Type: *Batu*
Technology Base: Clan OmniFighter
Tonnage: 40

Equipment		Mass
Engine:	280 XL	8
Thrust	9	
Overthrust	14	
Structural Integrity:	9	
Heat Sinks:	10 [20]	0
Fuel:	45	3
Cockpit:		3
Armor Factor:	154 + 10	8
	<i>Armor Value</i>	<i>Free Space</i>
Cockpit	10 + 6	—
Nose	38	6
Wings	30/30	4/4
Fuselage	30	2 (aft)
Engine	20	—

Weapons and Ammo	Location	Tonnage
<i>Primary Weapons Configuration</i>		
ER Large Laser	Nose	4
Medium Pulse Laser	RW	2
Medium Pulse Laser	RW	2
Medium Pulse Laser	LW	2
Medium Pulse Laser	LW	2
ER Medium Laser	Aft	1
Targeting Computer	Nose	3
2 Double Heat Sinks		2

Weapons and Ammo

Alternate Configuration A

	Location	Tonnage
Narc Missile Beacon	Nose	2
Ammo (Narc) 6	Nose	1
ER PPC	Nose	6
SRM 6	RW	1.5
SRM 6	RW	1.5
Ammo (SRM) 15	RW	1
SRM 6	LW	1.5
SRM 6	LW	1.5
Ammo (SRM) 15	LW	1
1 Double Heat Sink		1

Alternate Configuration B

Medium Pulse Laser	Nose	2
Medium Pulse Laser	Nose	2
Medium Pulse Laser	Nose	2
Medium Pulse Laser	RW	2
Medium Pulse Laser	RW	2
Medium Pulse Laser	LW	2
Medium Pulse Laser	LW	2
ER Medium Laser	Aft	1
Targeting Computer	Nose	3

Alternate Configuration C

Gauss Rifle	Nose	12
Ammo (Gauss) 8	Nose	1
ER Medium Laser	Nose	1
ER Medium Laser	Nose	1
ER Small Laser	RW	.5
ER Small Laser	RW	.5
ER Small Laser	LW	.5
ER Small Laser	LW	.5
ER Medium Laser	Aft	1

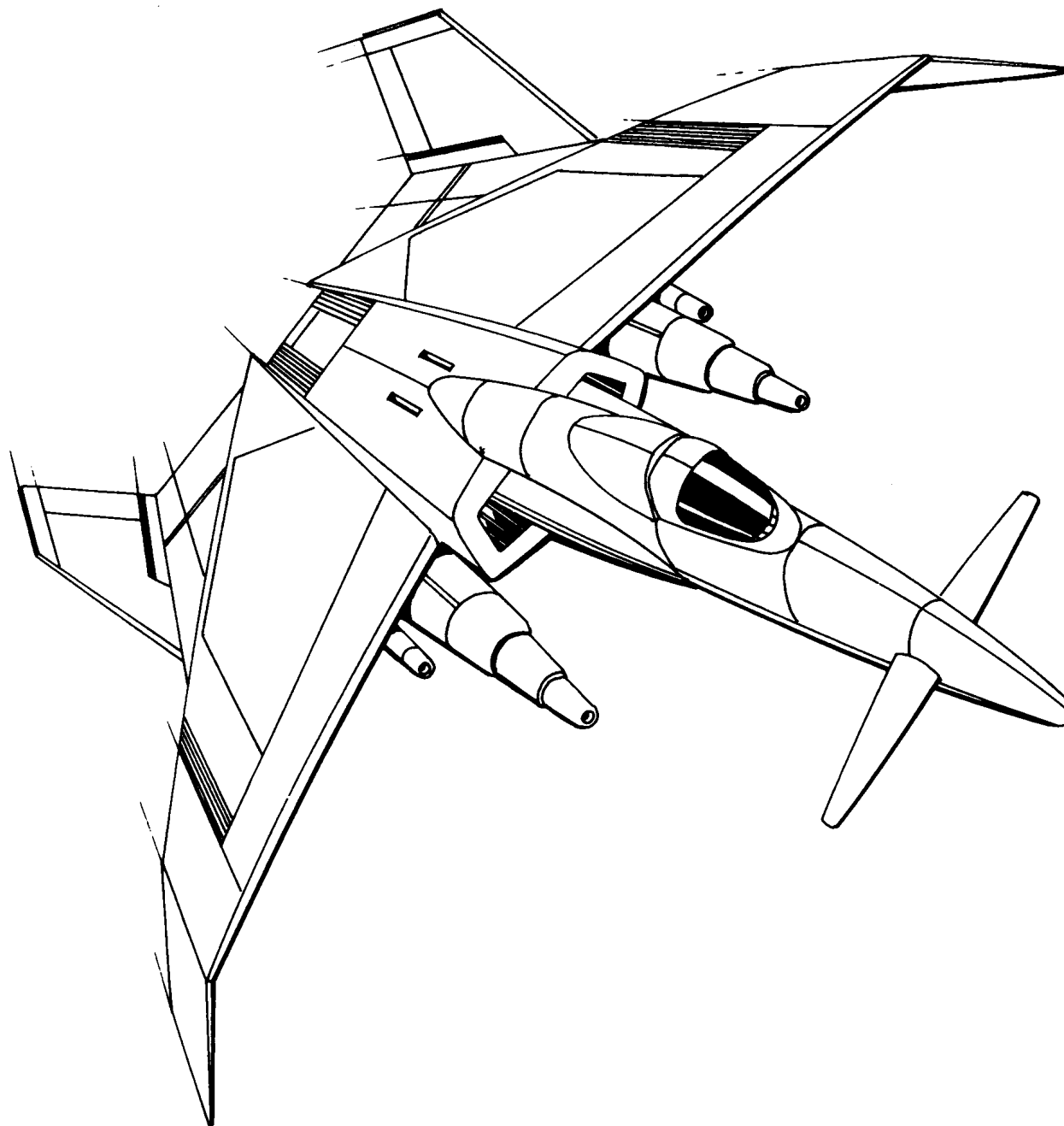

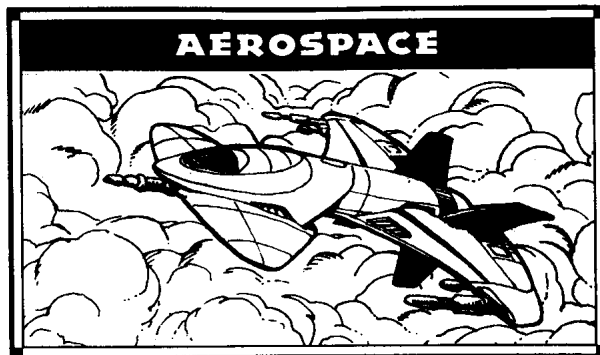

Mass: 45 tons
Frame: Unknown
Engine: 315 XL
Armor: Ferro-Aluminum
Armament:
 14.5 tons pod space available
Manufacturer: Unknown
Communications System: Unknown
Targeting and Tracking System: Unknown

Overview:

The *Sulla* is a maneuverable and well-protected medium OmniFighter. Its balance of armor and weaponry give it the ability to operate in conjunction with heavier or smaller fighters. Because of the superior staying power of the large fuel load, the *Sulla's* patrol ability and sustained thrust ability are rarely matched.

Capabilities:

The primary *Sulla* is a multi-role craft, seen on both ground-attack and interception missions. The main weapon is an ER PPC, which, though grossly inefficient, is able to wreck many light fighters with a single hit. The large pulse lasers mounted under each wing provide support fire in the form of a deadly accurate volley of fire against ground or air targets. Surprisingly, the *Sulla* mounts a small laser in the stern, which is supposed to deter pursuit, but provides very little real comfort to the pilot.

The A variant mounts both medium and large extended-range lasers in the nose, giving it limited

strafing ability. However, the main offensive weapons are the LRM launchers in each wing. These are slaved to an Artemis fire-control computer, improving their performance considerably. When combined, the two weapon systems give the *Sulla* a stand-off capability unrivalled in its class. The small laser mounted at the rear of the craft provides minimal defense.

The B variant follows the same theme as the A, using under-wing missile launchers slaved to Artemis systems to provide the offensive punch. The B exchanges the LRM-10 launchers of the previous variant for the devastating power of the huge LRM-20. Ammunition is much more limited, however, and the lack of any backup weapons often forces pilots to withdraw from combat before the battle is over.

The C variant is perhaps the most deadly of all, mounting an extended range PPC in each wing and a medium pulse laser in the nose. The absence of ammunition and the high endurance of the fighter make it ideal for long-range patrols, or for pursuit missions.

Deployment:

All of the Clans in the Inner Sphere have some *Sullas*, although the majority seem to be concentrated with Clans Smoke Jaguar and Ghost Bear. They are usually deployed in a supporting role, escorting transports and recon vehicles. Some are attached to ground units, and are used either for ground-attack vehicles, or more commonly, for aggressive combat air patrolling.

Type: *Sulla*
Technology Base: Clan OmniFighter
Tonnage: 45

Equipment		Mass
Engine:	315 XL	11
Thrust	9	
Overthrust	14	
Structural Integrity:	9	
Heat Sinks:	13 [26]	3
Fuel:	75	5
Cockpit:		3
Armor Factor:	163 + 10	8.5

	Armor Value	Free Space
Cockpit	10 + 6	—
Nose	30	6
Wings	31/31	4/4
Fuselage	40	2 (aft)
Engine	25	—

Weapons and Ammo	Location	Tonnage
<i>Primary Weapons Configuration</i>		
ER PPC	Nose	6
ER Large Laser	RW	4
ER Large Laser	LW	4
ER Small Laser	Aft	.5
<i>Alternate Configuration A</i>		
ER Large Laser	Nose	4
ER Medium Laser	Nose	1
LRM 10	RW	2.5
Ammo IV (LRM) 12	RW	1
Artemis IV FCS	RW	1
LRM 10	LW	2.5
Ammo IV (LRM) 12	LW	1
Artemis IV FCS	LW	1
ER Small Laser	Aft	.5
<i>Alternate Configuration B</i>		
LRM 20	RW	5
Ammo IV (LRM) 6	RW	1
Artemis IV FCS	RW	1
LRM 20	LW	5
Ammo IV (LRM) 6	LW	1
Artemis IV FCS	LW	1
ER Small Laser	Aft	.5
<i>Alternate Configuration C</i>		
Medium Pulse Laser	Nose	2
ER PPC	RW	6
ER PPC	LW	6
ER Small Laser	Aft	.5

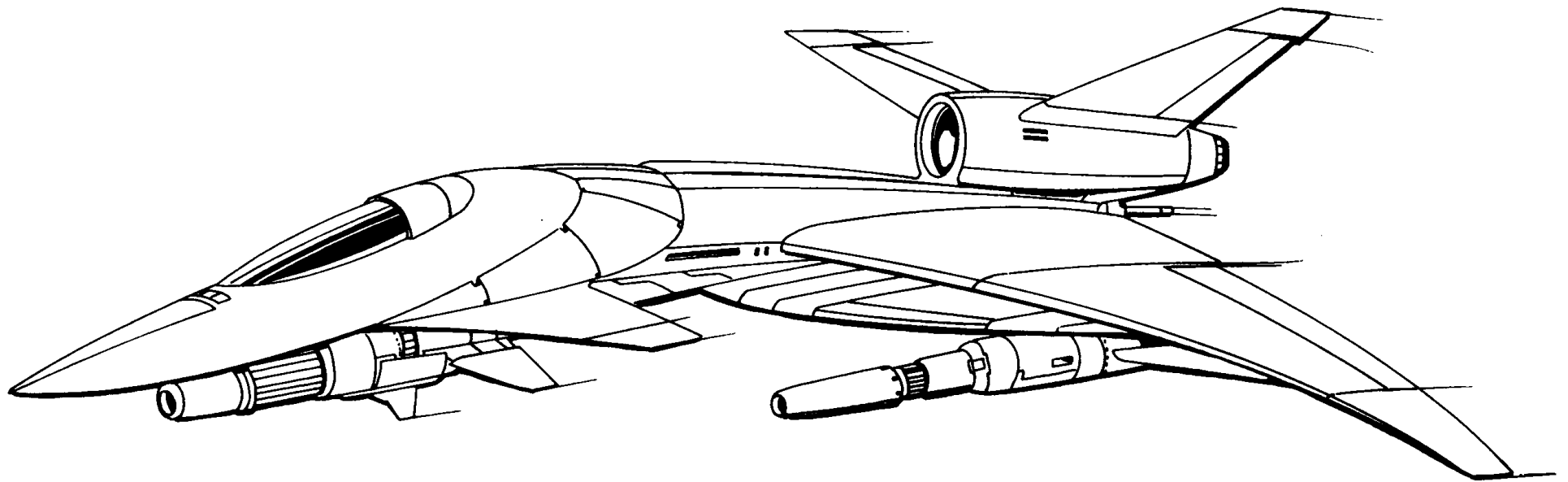

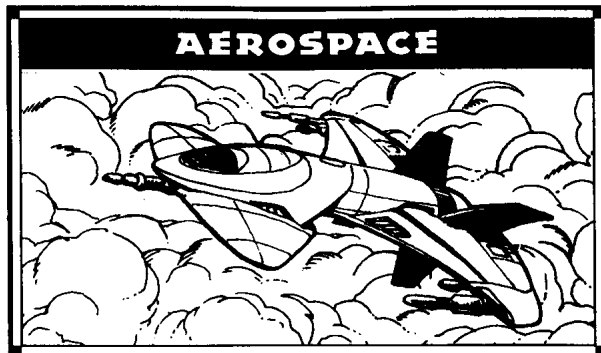

Mass: 50 tons

Frame: Unknown

Engine: 250 XL

Armor: Ferro-Aluminum

Armament:

24 tons pod space available

Manufacturer: Unknown

Communications System: Unknown

Targeting and Tracking System: Unknown

Overview:

For its class the *Turk* is well-protected and has an excellent weapons array, but these are at the expense of maneuverability. First fielded by Clan Burrock, the *Turk* is usually designated as an attack ship rather than a dogfighter, being used in missions against larger space vessels and against ground targets.

Capabilities:

The primary configuration is one of the multi-role designs, being armed with energy weapons suitable for both strafing and attacking airborne targets. Each wing mounts an ER PPC and an ER large laser, giving this fighter the ability to project fire over considerable distance. Mounting the weapons in wing pods restricts their firing arc, however, resulting in the fighter only being able to use these arms to engage targets directly ahead of it. The primary *Turk* also lacks any rear-firing armaments, which makes it vulnerable to tailing.

The A variant is best-suited to operations in space, as most of its weapons are ballistic, and thus unsuit-

able for strafing. A Gauss rifle is mounted along the fuselage of the fighter, and fires into the front arc. This primary assault weapon has two tons of ammunition, which is usually sufficient, but causes some problems in extended combat. As a precaution, an ER large laser is mounted alongside the Gauss rifle, firing into the same arc. Many *Turk* pilots use this weapon to supplement the "long-range" firepower. To resolve the problems of aiming the Gauss at closer targets, a pair of SRM-4 launchers is mounted in each wing, giving a fairly wide arc of fire. To counteract the aft-arc vulnerability of the primary, a medium pulse laser is mounted at the base of the *Turk's* tailplane.

The *Turk B* also usually performs in space operations, this time with a pair of autocannon-10s, one in each wing. Like the primary, this variant has difficulty in bringing all weapons to bear. Many enemy pilots take advantage of this, however, keeping to one side of the *Turk*, forcing it to use all its ammunition for one weapon, while keeping out of the arc of the other. As a consequence many *Turk Bs* are forced to make a tactical withdrawal from battles, relying on their twin ER lasers in the nose.

The *Turk C* variant again concentrates on ballistic weapons, this time short- and long-range missile launchers. The wing-mounted Streak 6 launchers often prove deadly in combat, while the LRM-20 in the nose provides useful, if limited, fire projection. Additional firepower is available from the wing-mounted large lasers.

Deployment:

Common with most Clans, save Wolf, Jade Falcon, and Steel Viper, the *Turk* serves in a number of roles, both with front-line units and with those in the rear. The Ghost Bears initially used a number of *Turk* and *Sulla* fighters in patrols aimed at curbing the guerrilla actions and raids that hampered their operations in the Inner Sphere. Although these craft were effective against forces willing to come out into the open, they were unable to counter terrorist tactics, forcing Clan Ghost Bear to request the assistance of the reserve Clan, the Steel Vipers.

Type: **Turk**

Technology Base: Clan OmniFighter

Tonnage: 50

Equipment		Mass
Engine:	250 XL	6.5
Thrust	7	
Overthrust	11	
Structural Integrity:	7	
Heat Sinks:	12 [24]	2
Fuel:	75	5
Cockpit:		3
Armor Factor:	182 + 10	9.5
	<i>Armor Value</i>	<i>Free Space</i>
Cockpit	10 + 6	—
Nose	30	6
Wings	30/30	4/4
Fuselage	54	2 (aft)
Engine	32	—

Weapons and Ammo	Location	Tonnage
<i>Primary Weapons Configuration</i>		
ER PPC	RW	6
ER PPC	LW	6
ER Large Laser	RW	4
ER Large Laser	LW	4
4 Double Heat Sinks		4
<i>Alternate Configuration A</i>		
Gauss Rifle	Nose	12
Ammo (Gauss) 16	Nose	2
ER Large Laser	Nose	4
SRM 4	RW	1
Ammo (SRM) 25	RW	1
SRM 4	LW	1
Ammo (SRM) 25	LW	1
Medium Pulse Laser	Aft	2

Weapons and Ammo	Location	Tonnage
<i>Alternate Configuration B</i>		
ER Medium Laser	Nose	1
ER Medium Laser	Nose	1
Ultra AC/10	RW	10
Ammo (Ultra) 10	RW	1
Ultra AC/10	LW	10
Ammo (Ultra) 10	LW	1
<i>Alternate Configuration C</i>		
LRM 20	Nose	5
Ammo (LRM) 12	Nose	2
ER Large Laser	RW	4
Streak SRM 6	RW	3
Ammo (Streak) 15	RW	1
ER Large Laser	LW	4
Streak SRM 6	LW	3
Ammo (Streak) 15	LW	1
ER Medium Laser	Aft	1

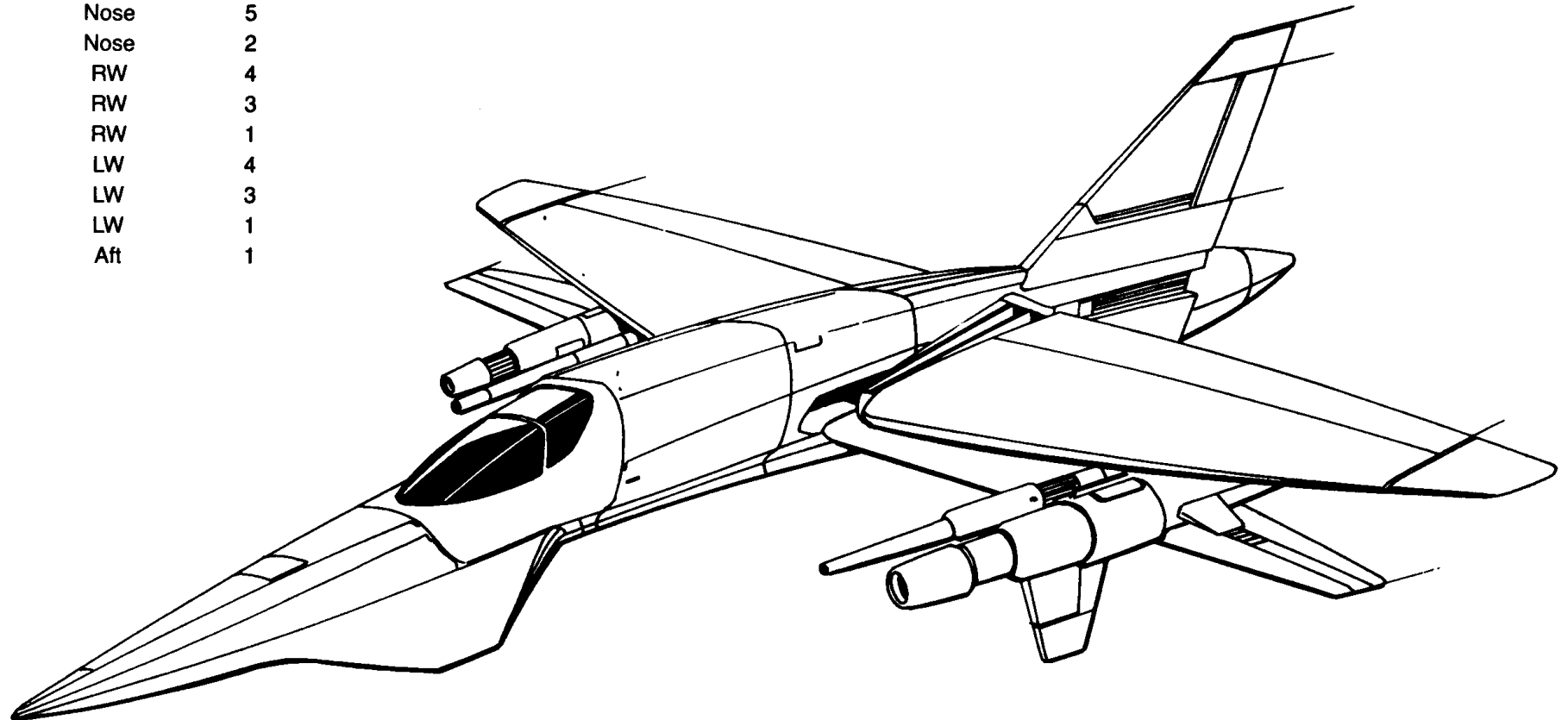

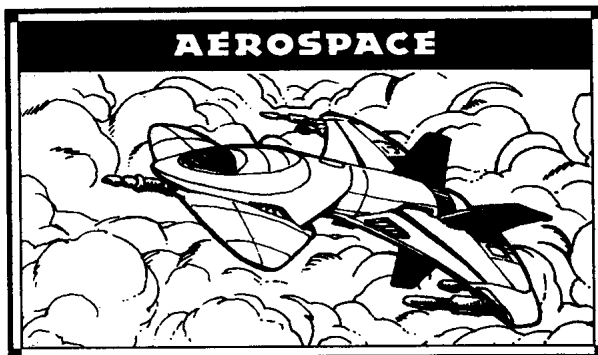

Mass: 60 tons

Frame: Unknown

Engine: 300 XL

Armor: Ferro-Aluminum

Armament:

26 tons pod space available

Manufacturer: Unknown

Communications System: Unknown

Targeting and Tracking System: Unknown

Overview:

The 60-ton *Visigoth* OmniFighter is second only to the *Jagatai* in popularity among front-line Clan units. Originally developed by the scientists of Clan Jade Falcon, this relatively old design has proved its worth, both in inter-Clan conflicts and in the recent invasion of the Inner Sphere.

Capabilities:

The primary configuration of the *Visigoth* carries a nose-mounted LB 10-X, which is supported by a triple mount of extended range medium lasers. Each wing supports a Streak SRM-4 and a small pulse laser. To discourage pursuit, the primary *Visigoth* carries two rear-mounted extended range medium lasers. The mix of ballistic and energy weapons provides this variant with good all-around performance.

The A variant carries a nose-mounted extended range PPC, which is set between a pair of extended range medium lasers. An LRM-20 launcher is slung under each wing, and this is slaved to an Artemis fire-control system.

This variant also mounts the usual rear-firing lasers, and is usually deployed in an air/space superiority role.

The B configuration is armed with two large lasers mounted in the nose, and an additional large laser mounted in each wing. A single aft-firing medium pulse laser replaces the more common twin extended lasers. This reliance on energy weapons makes the *Visigoth* B an ideal ground-attack and air/space-superiority fighter. The lack of ammunition also makes the B ideal for long-range patrols.

Like the B variant, the C relies heavily on pulse laser weaponry and is an excellent ground-attack vehicle. The nose and each of the wings mount a single large and medium pulse laser. An aft-firing SRM-4 rounds off the *Visigoth* C's armament.

Deployment:

The *Visigoth* is in service with all the Clans present in the Inner Sphere, and is seen in many front-line aeroStars. The number of *Visigoths* deployed with each Clan may be as high as 25 percent of the total aerospace force, and is rarely less than 10 percent. The fact that the design is more than a hundred years old and is still in front-line service is a testament to the abilities of the fighter and its pilots. However, newer designs such as the *Jagatai* are slowly replacing the aging *Visigoth*, and it is expected that within the next ten years the latter's use may be restricted to rear-echelon and garrison units.

Type: Visigoth

Technology Base: Clan OmniFighter

Tonnage: 60

Equipment

		Mass
Engine:	300 XL	9.5
Thrust	7	
Overthrust	11	
Structural Integrity:	7	
Heat Sinks:	16 [32]	6
Fuel:	75	5
Cockpit:		3
Armor Factor:	202 + 10	10.5

	Armor Value	Free Space
Cockpit	10 + 6	—
Nose	50	6
Wings	36/36	4/4
Fuselage	42	2 (aft)
Engine	32	—

Weapons and Ammo	Location	Tonnage
<i>Primary Weapons Configuration</i>		
LB 10-X AC	Nose	10
Ammo (LB-X) 30	Nose	3
ER Medium Laser	Nose	1
ER Medium Laser	Nose	1
ER Medium Laser	Nose	1
Streak SRM 4	RW	2
Ammo (Streak) 25	RW	1
Small Pulse Laser	RW	1
Streak SRM 4	LW	2
Ammo (Streak) 25	LW	1
Small Pulse Laser	LW	1
ER Medium Laser	Aft	1
ER Medium Laser	Aft	1
<i>Alternate Configuration A</i>		
ER PPC	Nose	6
ER Medium Laser	Nose	1
ER Medium Laser	Nose	1
LRM 20	RW	5
Ammo (LRM) 12	RW	2
Artemis IV FCS	RW	1
LRM 20	LW	5
Ammo (LRM) 12	LW	2
Artemis IV FCS	LW	1
ER Medium Laser	Aft	1
ER Medium Laser	Aft	1

Weapons and Ammo

Alternate Configuration B

	Location	Tonnage
Large Pulse Laser	Nose	6
Large Pulse Laser	Nose	6
Large Pulse Laser	RW	6
Large Pulse Laser	LW	6
Medium Pulse Laser	Aft	2

Alternate Configuration C

Large Pulse Laser	Nose	6
Medium Pulse Laser	Nose	2
Large Pulse Laser	RW	6
Medium Pulse Laser	RW	2
Large Pulse Laser	LW	6
Medium Pulse Laser	LW	2
SRM 4	Aft	1
Ammo (SRM) 25	Aft	1

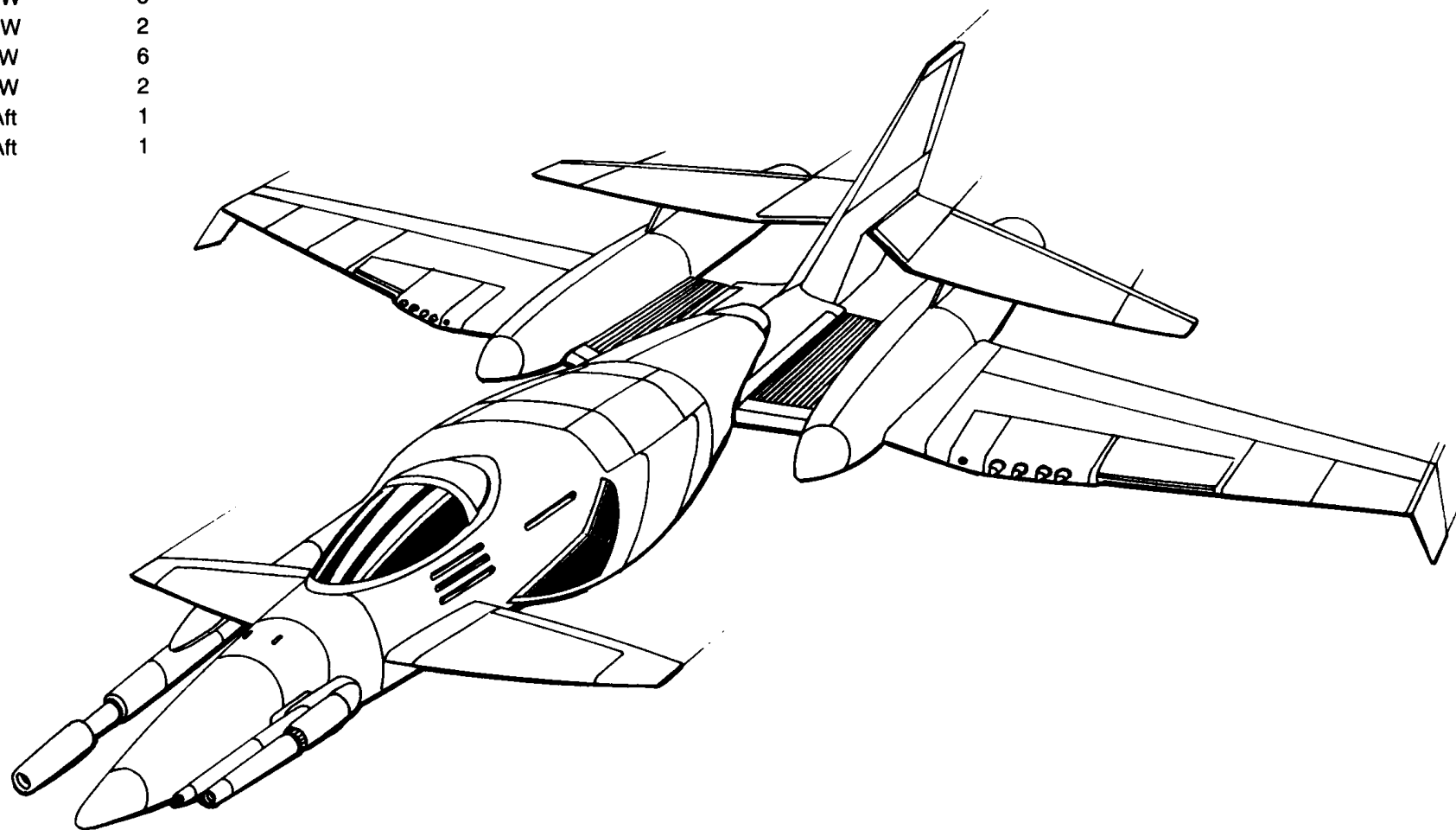

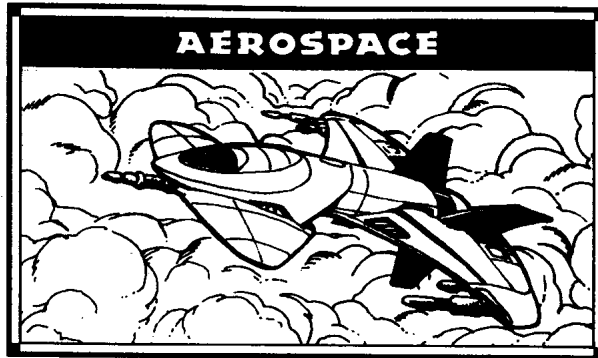

Mass: 70 tons
Frame: Unknown
Engine: 280 XL
Armor: Ferro-Aluminum
Armament:
 39 tons pod space available
Manufacturer: Unknown
Communications System: Unknown
Targeting and Tracking System: Unknown

Overview:

The Wolf Clan's *Jagatai* heavy OmniFighter has participated extensively in the recent invasion of the Inner Sphere, in both ground-attack and air-superiority roles. First fielded in 3016, the prototype *Jagatais* proved their worth in several Trials of Possession, with the Smoke Jaguars and Nova Cats falling victim. The Wolves' victims underestimated the versatility of the new fighter in these initial trials, and the Khan was sufficiently impressed to order the commencement of full-scale production in 3019. The *Jagatai* has since become the standard heavy fighter of the Wolf Clan, but is also distributed throughout the rest of the Clans, save for the Ghost Bears, who prefer the heavier *Jengiz*.

Capabilities:

Though only average in maneuverability for its size, the 70-ton *Jagatai* serves extensively as an air-superiority fighter. It mounts more armor than its nearest rivals (the aging *Visigoth* and new *Sabuta*), and its

larger fuel tanks allow it to linger on-station for longer periods. It suffers, however, from the same flaw as many OmniFighters—poor heat dissipation. The Clans seem to prefer not to modify the basic chassis, but instead create a careful mix of efficient weapons and pod-mounted heat sinks to prevent overheating.

The primary configuration mounts an ER PPC weapons-pod on the inner pylon of each wing. A large pulse laser is also mounted upon each wing, though these are usually mounted on the outer wing pylons to minimize the likelihood of a single shot damaging both weapons. Directly below the cockpit is a large long-range missile system, the back-blast of which caused visibility problems on the early *Jagatai*. An aft-firing large pulse laser provides a means of discouraging pursuit, as few enemy pilots will risk its deadly accuracy.

The A variant swaps the accuracy of pulse laser weaponry for the sheer stopping power of an Ultra-20 autocannon. This nose-mounted cannon, together with its four tons of ammunition, provides the fighter with the potential to destroy an enemy fighter with a single volley. Due to the range limitations of the autocannon, however, the designers have mounted an ER PPC in the space between the autocannon and the cockpit, forcing the installation of additional heat sinks to prevent an ammunition explosion. Almost as an afterthought, the designers added a Streak missile launcher in each wing, providing a wider arc of fire, and a rear-firing extended range laser.

The B variant of the *Jagatai* carries two huge Gauss rifles mounted along the fuselage, with their muzzles in the nose of the fighter. These provide a huge damage potential, while generating considerably less heat than a PPC or laser, and without risking an ammunition explosion. A reasonable store of ammunition is kept for each rifle, but even this can be exhausted during a prolonged engagement, forcing the pilot to fall back on the extended range large lasers mounted in each wing.

The *Jagatai C* looks superficially like the A, with a large autocannon in the nose (this time an LB 20-X). However, rather than a single energy weapon, the cannon is backed up by two extended-range large lasers.

The lasers, when combined with the wing-mounted missile launchers, give the C a good ranged-attack ability, though most pilots prefer close-in engagements that permit use of the autocannon. The knowledge that the *Jagatai C* carries two large lasers firing into the aft arc (one pulse, the other extended-range) discourages most pilots from using the "slot" when attacking this variant.

Deployment:

The largest concentration of *Jagatais* is in Clan Wolf, its original manufacturer, although the other Clans (with the exception of Ghost Bears) have a fair number. In many Clans the *Jagatai* is replacing older fighters such as the *Visigoth*, although the pace of this upgrade varies from Clan to Clan.

Type: **Jagatai**

Technology Base: Clan OmniFighter

Tonnage: 70

Equipment		Mass
Engine:	280 XL	8
Thrust	6	
Overthrust	9	
Structural Integrity:	7	
Heat Sinks:	15 [30]	5
Fuel:	60	4
Cockpit:		3
Armor Factor:	211 + 10	11
	<i>Armor Value</i>	<i>Free Space</i>
Cockpit	10 + 6	—
Nose	46	6
Wings	36/36	4/4
Fuselage	55	2 (aft)
Engine	32	—

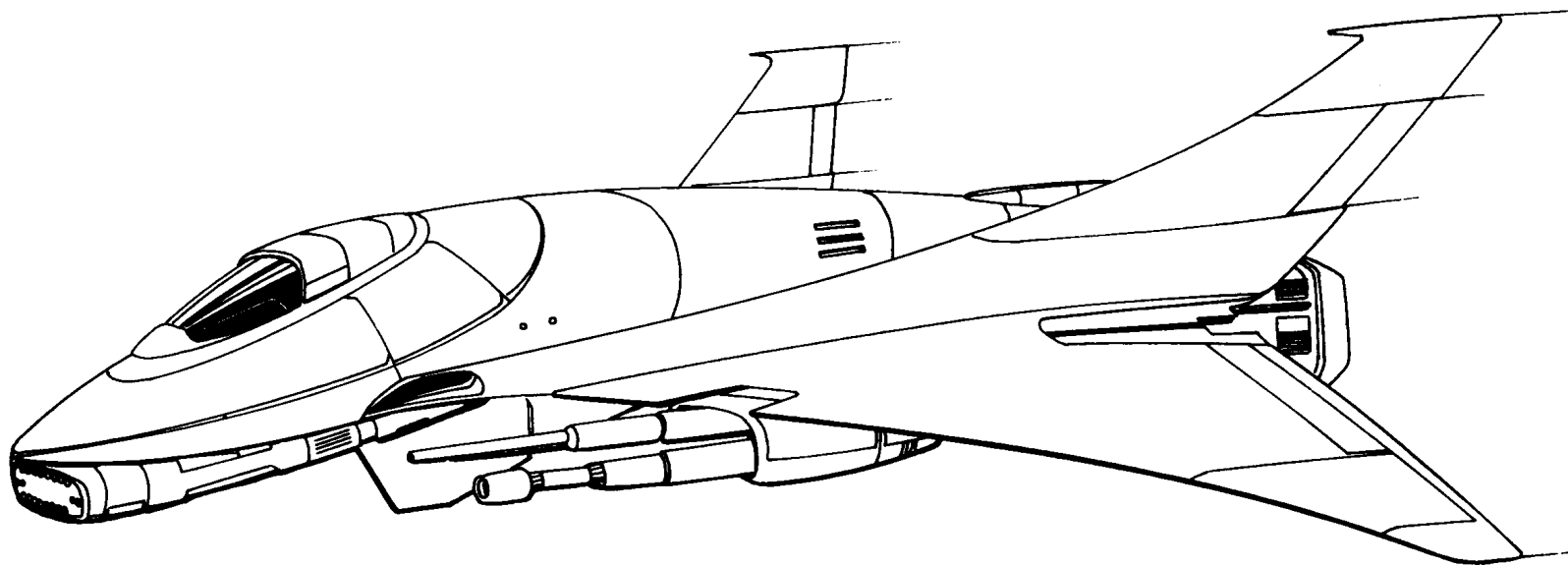

Weapons and Ammo	Location	Tonnage	Weapons and Ammo	Location	Tonnage
<i>Primary Weapons Configuration</i>			<i>Alternate Configuration B</i>		
ER PPC	RW	6	Gauss Rifle	Nose	12
ER PPC	LW	6	Ammo (Gauss) 16	Nose	2
Large Pulse Laser	RW	6	Gauss Rifle	Nose	12
Large Pulse Laser	LW	6	Ammo (Gauss) 16	Nose	2
LRM 20	Nose	5	ER Large Laser	RW	4
Ammo (LRM) 12	Nose	2	ER Large Laser	LW	4
Large Pulse Laser	Aft	6	Medium Pulse Laser	Aft	2
2 Double Heat Sinks		2	ER Medium Laser	Aft	1
<i>Alternate Configuration A</i>			<i>Alternate Configuration C</i>		
Ultra AC/20	Nose	12	LB 20-X AC	Nose	12
Ammo (Ultra) 20	Nose	4	Ammo (LB-X) 10	Nose	2
ER PPC	Nose	6	ER Large Laser	Nose	4
Streak SRM 6	RW	3	ER Large Laser	Nose	4
Ammo (Streak) 15	RW	1	LRM 10	RW	2.5
Streak SRM 6	LW	3	Ammo (LRM) 12	RW	1
Ammo (Streak) 15	LW	1	LRM 10	LW	2.5
ER Large Laser	Aft	4	Ammo (LRM) 12	LW	1
5 Double Heat Sinks		5	Large Pulse Laser	Aft	6
			ER Large Laser	Aft	4



Mass: 75 tons
Frame: Unknown
Engine: 300 XL
Armor: Ferro-Aluminum
Armament:
 44.5 tons pod space available
Manufacturer: Unknown
Communications System: Unknown
Targeting and Tracking System: Unknown

Overview:

The Smoke Jaguars' *Sabutai* heavy OmniFighter packs an awesome array of firepower. This is paid for, however, by a relative reduction of armor protection for the fighter, which is only partly offset by the application of ferro-aluminum armor. The basic chassis has a poor heat-dissipation rate, given the massive firepower potential, a problem that can lead to a loss of control during battle. The difficulty has been rectified somewhat by the addition of extra heat sinks and also by the use of more efficient weaponry in some configurations.

Capabilities:

The main weapon of the primary *Sabutai* is a nose-mounted Gauss rifle, with an extended-range small laser mounted directly above. This variant also boasts an impressive array of weaponry in the wings, with each bearing an extended-range PPC, coupled with a deadly accurate large pulse laser. The fighter's rear is covered almost as an afterthought by two ER small lasers. To help cope with the heat output, six dou-

ble heat sinks have also been mounted along the fuselage and wings.

The A variant packs an incredible punch in the form of a matching set of underwing autocannons, both being the largest available in the Ultra series. These are backed up by an LB 20-X which is mounted under the fighter's nose. Should the pilot expend all his ammunition, he is well-advised to return to base, for the *Sabutai's* only other forward-firing armament consists of three extended-range small lasers. A pair of medium lasers cover the rear of the craft, which helps the fighter discourage pursuit.

The B variant is rare, having been seen only with the Nova Cat and Steel Viper Clans. It boasts a large array of sophisticated electronics, not the least of which is an ECM suite, which provides protection from fire control and sophisticated sensor systems. These permit the craft to fulfill its role as an artillery spotter, using the TAG system to designate for Arrow IV artillery missiles launched from ground vehicles. The B carries five forward-launching LRM-20s, two in each wing, and one in the nose, which can take advantage of deployed Narc pods. The remainder of the weaponry consists of a large pulse laser and an ER small laser, firing from the nose, and a rear-firing medium pulse laser.

The C variant is an exceedingly efficient machine, equally well-suited for strafing and dogfighting, though its all-energy-weapon configuration makes it exceptional at the former. The fighter has four ER large lasers, arranged in a nose quad mount, with an ER small laser forming the core. The wings each mount three ER medium lasers, usually arranged in a triangular pattern at the wing root. To vent excess heat, most of the surface of this variant is covered with heat dissipation units, which add twenty-two tons to the standard cooling system.

Deployment:

A brand-new design, the *Sabutai* was first used in real combat during the Trials of Position that determined the participants in the Clan invasion of the Inner Sphere.

Type: **Sabutai**
 Technology Base: Clan OmniFighter
 Tonnage: 75

Equipment		Mass
Engine:	300 XL	9.5
Thrust	6	
Overthrust	9	
Structural Integrity:	7	
Heat Sinks:	15 [30]	5
Fuel:	45	3
Cockpit:		3
Armor Factor:	192 + 10	10
	<i>Armor Value</i>	<i>Free Space</i>
Cockpit	10 + 6	—
Nose	46	6
Wings	35/35	4/4
Fuselage	40	2 (aft)
Engine	30	—

Weapons and Ammo	Location	Tonnage
<i>Primary Weapons Configuration</i>		
Gauss Rifle	Nose	12
Ammo (Gauss) 8	Nose	1
ER Small Laser	Nose	.5
ER PPC	RW	6
Large Pulse Laser	RW	6
ER PPC	LW	6
Large Pulse Laser	LW	6
ER Small Laser	Aft	.5
ER Small Laser	Aft	.5
6 Double Heat Sinks		6

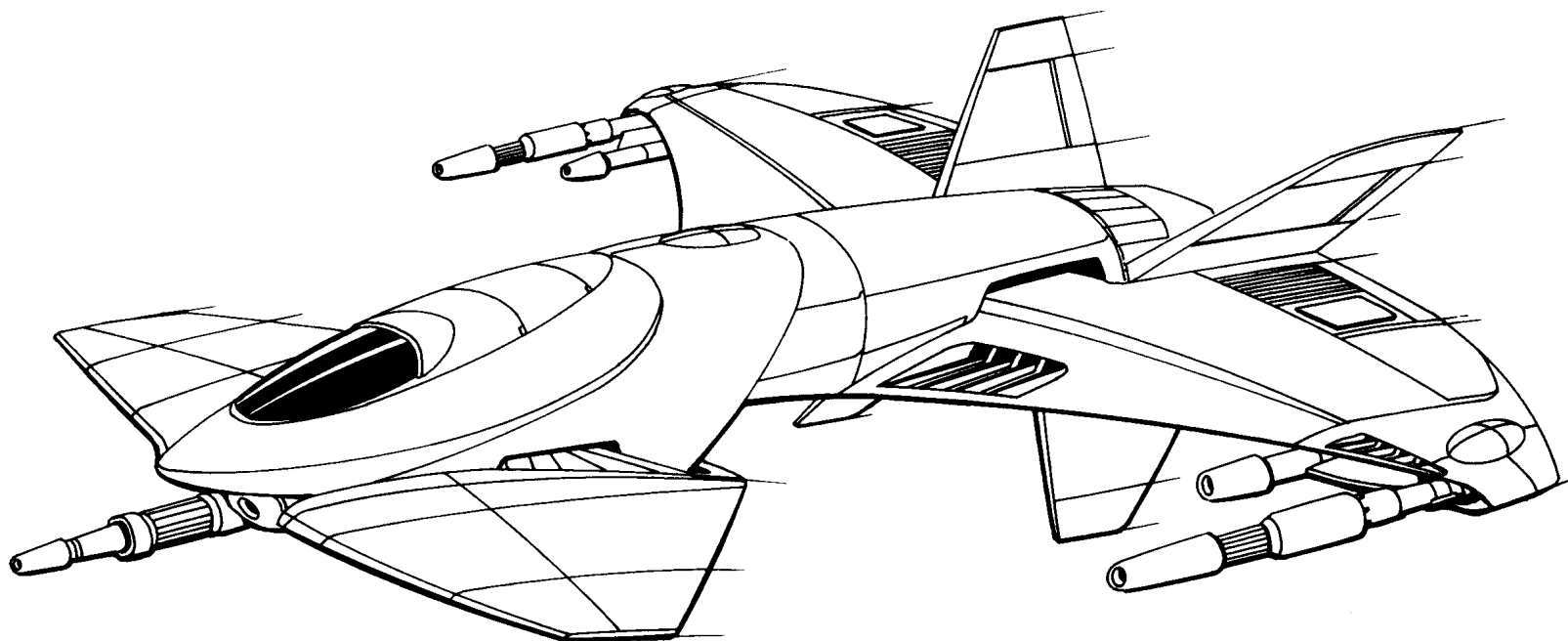

Weapons and Ammo
Alternate Configuration A

Weapons and Ammo	Location	Tonnage
LB 20-X AC	Nose	12
Ammo (LB-X) 15	Nose	3
ER Small Laser	Nose	.5
Ultra AC/20	RW	12
Ammo (Ultra) 5	RW	1
ER Small Laser	RW	.5
Ultra AC/20	LW	12
Ammo (Ultra) 5	LW	1
ER Small Laser	LW	.5
ER Medium Laser	Aft	1
ER Medium Laser	Aft	1

Weapons and Ammo
Alternate Configuration B

Weapons and Ammo	Location	Tonnage
ECM Suite	Aft	1
TAG	Nose	1
Narc Missile Beacon	Nose	2
Ammo (Narc) 12	Nose	2
LRM 20	Nose	5
Ammo (LRM) 6	Nose	1
Large Pulse Laser	Nose	6
LRM 20	RW	5
Ammo (LRM) 6	RW	1
LRM 20	RW	5
Ammo (LRM) 6	RW	1
LRM 20	LW	5
Ammo (LRM) 6	LW	1
LRM 20	LW	5
Ammo (LRM) 6	LW	1
Medium Pulse Laser	Aft	2
ER Small Laser	Nose	.5

Weapons and Ammo
Alternate Configuration C

Weapons and Ammo	Location	Tonnage
ER Large Laser	Nose	4
ER Large Laser	Nose	4
ER Large Laser	Nose	4
ER Large Laser	Nose	4
ER Small Laser	Nose	.5
ER Medium Laser	RW	1
ER Medium Laser	RW	1
ER Medium Laser	RW	1
ER Medium Laser	LW	1
ER Medium Laser	LW	1
ER Medium Laser	LW	1
22 Double Heat Sinks	LW	22

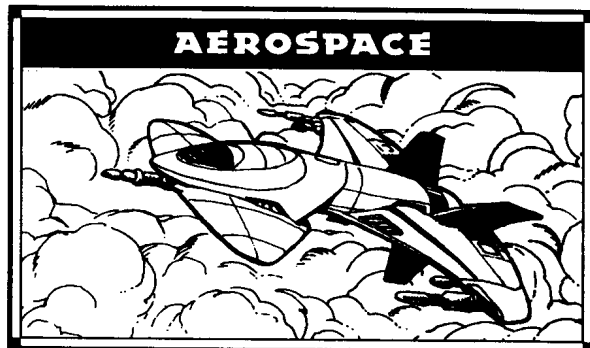

Mass: 80 tons

Frame: Unknown

Engine: 240 XL

Armor: Ferro-Aluminum

Armament:

43.5 tons pod space available

Manufacturer: Unknown

Communications System: Unknown

Targeting and Tracking System: Unknown

Overview:

The 80-ton *Jengiz* is one of the heaviest and fiercest fighters fielded by the Clans. Developed in 3032 by Clan Ghost Bear, it has only been in active service for the last 15 years, but has stirred up considerable interest among the other Clans. Only Clan Wolf has succeeded in the Trials of Possession needed to secure the designs, however. The other Clans that use the *Jengiz* have captured them from either the Wolf Clan or the Ghost Bears.

Capabilities:

Because of its relatively poor maneuverability, the *Jengiz* has limited use in atmosphere, and is deployed mainly in near-space defense. In some cases its performance is worse than Inner Sphere fighters of similar mass, but pilots should be wary of misjudging the fighter, as it is heavily armored, dissipates heat easily, and has more than 50 percent of its body-weight devoted to offensive systems.

The primary *Jengiz* carries a formidable array of weaponry. An LB 10-X, ER PPC, medium pulse laser, and ER small laser are all crammed into the nose, while each wing mounts a large and medium pulse laser and an SRM-6. Firing into the aft arc is a rear-wing medium pulse laser, and an ECM suite interferes with the effects of advanced fire-control computers.

The A variant is the only one generally involved in ground attacks. The twin ER PPCs in the nose, and the twin large pulse lasers under each wing give it superb strafing ability, and the addition of double heat sinks allows repeated attack runs. An ER small laser fires aft to discourage tailing.

The rare *Jengiz* B is configured to engage targets at long range. It carries a Gauss rifle in the nose, and has an ER PPC and LRM-20 (with Artemis FCS) under each wing. Two forward-firing ER medium lasers are mounted in the nose to boost close-in firepower, and the rear of the fighter is equipped with an ER small laser. Although the Gauss rifle carries sufficient ammunition for prolonged operations, the LRM-20 ammunition is severely limited. Running out of ammunition, *Jengiz* pilots often jettison the LRM pods part way through a battle, improving the fighter's maneuverability slightly.

The C variant of the *Jengiz* is one of the most unusual configurations fielded by the Clans. Based on a philosophy different from most fighters, the C variant is believed to have evolved from the few *Jengiz* used by Clan Goliath Scorpion. An LB 20-X series autocannon is mounted under each wing, and a triple mount of Streak SRM-6 launchers are mounted in the nose along with an ER small laser. This version also carries an aft-firing Streak SRM-4. If the *Jengiz* C has a disadvantage, it is the short range of its weapons. For that reason, the C is usually paired with another variant with longer-range capabilities.

Deployment:

The *Jengiz* is common in Clans Wolf and Ghost Bear, but is rare among the other invading Clans. Over the last 20 years, the relatively new *Jengiz* has been replacing the venerable *Kirghiz* as the main super-

heavy fighter in a number of the Clans, and may completely replace the heavier, but less efficient design in the next decade.

Type: *Jengiz*

Technology Base: Clan OmniFighter

Tonnage: 80

Equipment		Mass
Engine:	240 XL	6
Thrust	5	
Overthrust	8	
Structural Integrity:	8	
Heat Sinks:	20 [40]	10
Fuel:	60	4
Cockpit:		3
Armor Factor:	259 + 10	13.5
	<i>Armor Value</i>	<i>Free Space</i>
Cockpit	10 + 6	—
Nose	65	6
Wings	47/47	4/4
Fuselage	62	2 (aft)
Engine	32	—

Weapons and Ammo	Location	Tonnage
<i>Primary Weapons Configuration</i>		
LB 10-X AC	Nose	10
Ammo (LB-X) 10	Nose	1
ER PPC	Nose	6
Medium Pulse Laser	Nose	2
ER Small Laser	Nose	.5
Large Pulse Laser	RW	6
Medium Pulse Laser	RW	2
SRM 6	RW	1.5
Ammo (SRM) 15	RW	1
Large Pulse Laser	LW	6
Medium Pulse Laser	LW	2
SRM 6	LW	1.5
Ammo (SRM) 15	LW	1
Medium Pulse Laser	Aft	2
ECM Suite	Aft	1

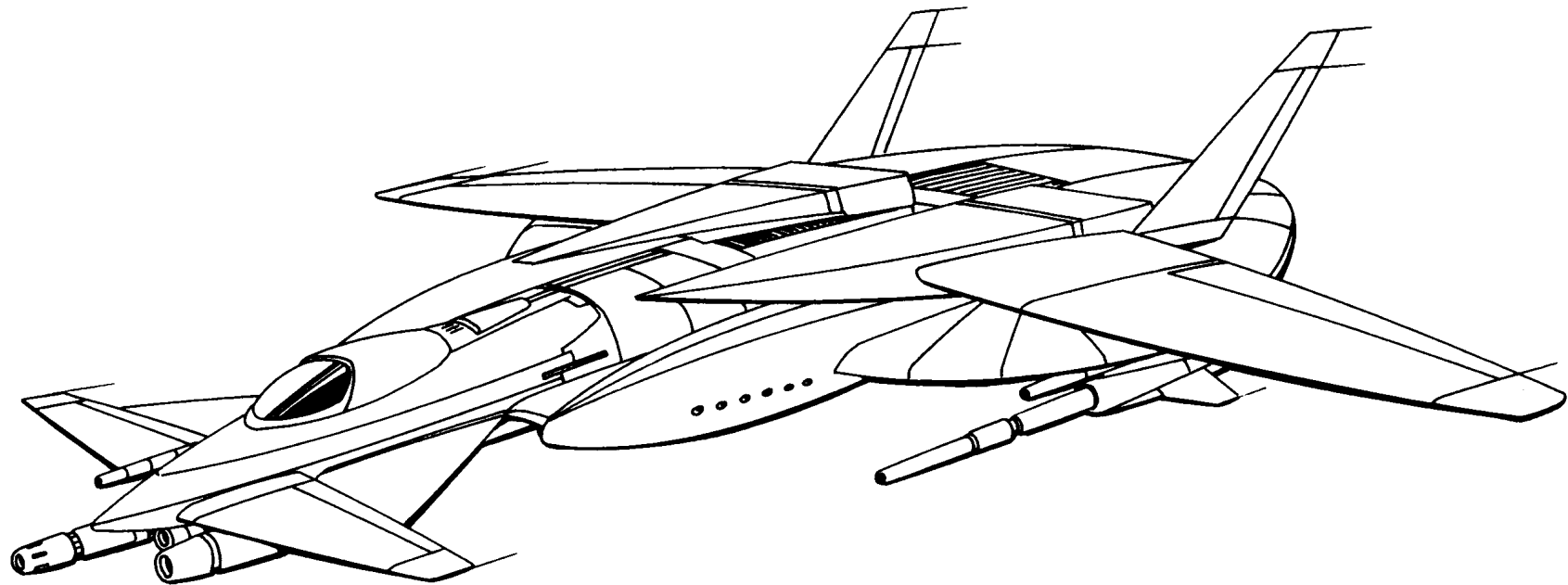

Weapons and Ammo
Alternate Configuration A
 ER PPC
 ER PPC
 Large Pulse Laser
 Large Pulse Laser
 Large Pulse Laser
 Large Pulse Laser
 ER Small Laser
 7 Double Heat Sinks

Location	Tonnage
Nose	6
Nose	6
RW	6
RW	6
LW	6
LW	6
Aft	.5
	7

Weapons and Ammo
Alternate Configuration B
 Gauss Rifle
 Ammo (Gauss) 24
 ER Medium Laser
 ER Medium Laser
 ER PPC
 LRM 20
 Ammo (LRM) 6
 Artemis IV FCS
 ER PPC
 LRM 20
 Ammo (LRM) 6
 Artemis IV FCS
 ER Small Laser

Location	Tonnage
Nose	12
Nose (3)	3
Nose	1
Nose	1
RW	6
RW	5
RW	1
RW	1
LW	6
LW	5
LW	1
LW	1
Aft	.5

Weapons and Ammo
Alternate Configuration C
 Streak SRM 6
 Streak SRM 6
 Streak SRM 6
 Ammo (Streak) 45
 LB 20-X AC
 Ammo (LB-X) 10
 LB 20-X AC
 Ammo (LB-X) 10
 Streak SRM 4
 Ammo (Streak) 25
 ER Small Laser

Location	Tonnage
Nose	3
Nose	3
Nose	3
Nose	3
RW	12
RW	2
LW	12
LW	2
Aft	2
Aft	1
Aft	.5

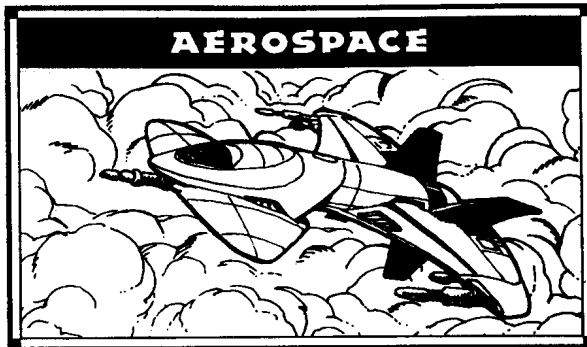

Mass: 90 tons
Frame: Unknown
Engine: 360 XL
Armor: Ferro-Aluminum
Armament:
 42.5 tons pod space available
Manufacturer: Unknown
Communications System: Unknown
Targeting and Tracking System: Unknown

Overview:

When the Clan Jade Falcon commanders wanted their own super-heavy fighter design, they asked for a craft that could face all comers, maneuverable enough to worry fighters lighter than itself, but with enough staying power from armor and fuel to make it a match for the few heavier fighters. Until Clan Ghost Bear began fielding the *Jengiz*, this fighter rivaled even the venerable *Kirghiz*.

The Jade Falcons have been somewhat loath to share the design, resulting in few other Clans possessing the *Scytha*, except as the spoils of war. This is fortunate for the Inner Sphere, as would be anything that prevents the wide-scale deployment of such a lethal fighter.

Capabilities:

The primary *Scytha* is a fearsome beast whose nose is packed with weaponry. The primary close-in weapon is an Ultra-20 autocannon, with plentiful ammunition, with backup from the nose-mounted large

and small lasers. The wings carry the primary long-range weaponry, an extended-range large laser in each wing-root mount, with another mounted on the wing-tip. To aid heat dissipation extra heat sinks were added along the fuselage. A paired array of ER medium lasers completes the *Scytha's* weaponry, firing into the aft arc to discourage pursuit.

The A variant carries a Narc missile beacon and three LRM-20 racks. For close-in engagements, it is also equipped with three SRM-6 launchers. An ER large laser is mounted in each wing-tip pod, providing backup for the LRM launcher, and these are the only energy weapons in the fighter. A Streak SRM-6 launcher is mounted in the vessel's rear, discouraging use of the slot by attacking fighters.

The B configuration is another battlefield support vehicle, although it is designed for strafing. To this end, the variant mounts five large pulse lasers, slaved to a targeting computer, which provides devastatingly accurate firepower. This variant's unusual feature is its anti-missile system, a component unusual on aerospace fighters. Two medium pulse lasers are oriented to fire into the aft arc.

The C variant's firepower is concentrated in the wings, with each having a Gauss rifle and an ER PPC. A pair of nose-mounted lasers provide additional fire into the forward arc. An extended range small laser is mounted in the rear of the craft, although this is rarely used. Many pilots prefer to rely upon the fighter's above-average maneuverability to bring its main weaponry to bear.

Deployment:

Currently concentrated with Clan Jade Falcon, only a handful of *Scytha* fighters are used by other Clans, primarily the Wolves and Nova Cats. Any massive deployment of this fighter will surely destroy any pretense of equality in aerospace engagements between the Clans and the Inner Sphere.

Type: *Scytha*
Technology Base: Clan OmniFighter
Tonnage: 90

Equipment		Mass
Engine:	360 XL	16.5
Thrust	6	
Overthrust	9	
Structural Integrity:	9	
Heat Sinks:	20 [40]	10
Fuel:	60	4
Cockpit:		3
Armor Factor:	269 + 10	14
	Armor Value	Free Space
Cockpit	10 + 6	—
Nose	67	6
Wings	50/50	4/4
Fuselage	64	2 (aft)
Engine	32	—

Weapons and Ammo	Location	Tonnage
<i>Primary Weapons Configuration</i>		
Ultra AC/20	Nose	12
Ammo (Ultra) 10	Nose	2
ER Small Laser	Nose	.5
ER Large Laser	Nose	4
ER Large Laser	RW	4
ER Large Laser	RW	4
ER Large Laser	LW	4
ER Large Laser	LW	4
ER Medium Laser	Aft	1
ER Medium Laser	Aft	1
6 Double Heat Sinks		6

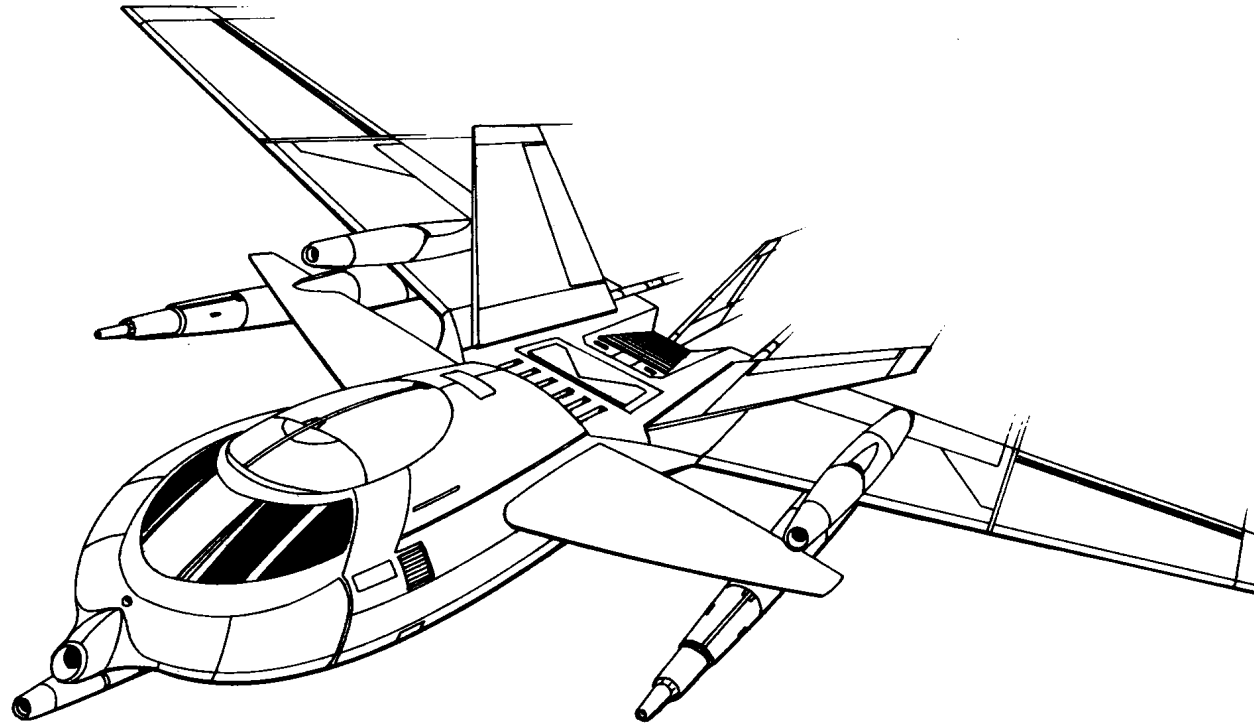

Weapons and Ammo
Alternate Configuration A

Weapons and Ammo	Location	Tonnage
Narc Missile Beacon	Nose	2
Ammo (Narc) 6	Nose	1
LRM 20	Nose	5
Ammo (LRM) 6	Nose	1
SRM 6	Nose	1.5
Ammo (SRM) 15	Nose	1
LRM 20	RW	5
Ammo (LRM) 6	RW	1
SRM 6	RW	1.5
ER Large Laser	RW	4
LRM 20	LW	5
Ammo (LRM) 6	LW	1
SRM 6	LW	1.5
ER Large laser	LW	4
Streak SRM 6	Aft	3
Ammo (Streak) 15	Aft	1
4 Double Heat Sinks		4

Weapons and Ammo
Alternate Configuration B

Weapons and Ammo	Location	Tonnage
Large Pulse Laser	Nose	6
Anti-Missile System	Nose	.5
Ammo (Anti-Missile) 24	Nose	1
Large Pulse Laser	RW	6
Large Pulse Laser	RW	6
Large Pulse Laser	LW	6
Large Pulse Laser	LW	6
Medium Pulse Laser	Aft	2
Medium Pulse Laser	Aft	2
Targeting Computer	Nose	7

Weapons and Ammo
Alternate Configuration C

Weapons and Ammo	Location	Tonnage
Medium Pulse Laser	Nose	2
Medium Pulse Laser	Nose	2
Gauss Rifle	RW	12
Ammo (Gauss) 8	RW	1
ER PPC	RW	6
Gauss Rifle	LW	12
Ammo (Gauss) 8	LW	1
ER PPC	LW	6
ER Small Laser	Aft	.5

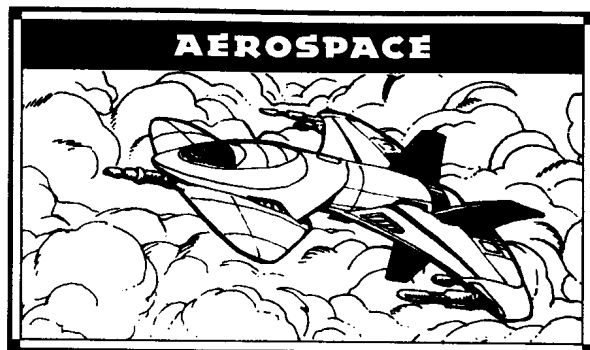

Mass: 100 tons

Frame: Unknown

Engine: 300 XL

Armor: Standard

Armament:

56.5 tons pod space available

Manufacturer: Unknown

Communications System: Unknown

Targeting and Tracking System: Unknown

Overview:

Currently the heaviest fighter in service with any Clan, the 100-ton *Kirghiz* rivals the *Scytha* for the title of "deadliest" fighter in service. A terrible foe, the *Kirghiz* is able to mount more forward-firing weaponry than any other OmniFighter, rivaling some assault DropShips. What gives the craft this ability is the use of conventional armor plating instead of the bulky ferro-aluminum armor. This provides more space for mounting weapons, but it also requires the addition of approximately 20 percent more armor plating to provide the same level of protection.

Capabilities:

First fielded by the Ghost Bears in 2874, this ancient design is one of the oldest Clan fighters built, let alone still in service. The fourth type of OmniFighter built, it has undergone several design modifications. The most radical was the addition of a more efficient XL-series engine, which provided considerably improved maneuverability. The steady development of weaponry within the Clans has kept the *Kirghiz* a most deadly fight-

er, with smaller and more efficient weaponry gradually replacing its Star League-vintage arms over the years.

The primary configuration of the *Kirghiz* mounts an LB 10-X autocannon in the nose. The main guns are two Gauss rifles, and mounted in a side-car pod with each Gauss rifle is an extended-range large laser. The aft weaponry primarily consists of a Streak SRM-6 launcher mounted in each wing, facing the rear. A small laser mounted in the tail provides additional support in close-in engagements.

The A variant carries the longest-range weaponry that an aerospace fighter can mount: an LB 2-X, one on each wing-tip, together with a huge amount of ammunition. Twin ER PPCs are mounted in the nose, and twin-mount large pulse lasers sit in each wing. Although the A version lacks the all-round firing ability of the primary, it does mount small and large extended range lasers in a rear-facing turret. This fighter's greatest problem is heat dissipation. If all the forward-firing weapons were fired at a single target, the ammunition for the autocannon could conceivably "cook off," destroying the wings, and probably the rest of the vessel.

Because of the limitations on the B variant's supply of ammunition for its five LRM-20 racks, the fighter is not popular with its pilots. This huge array of missile launchers often proves lethal against other fighters as well as ground targets, where FASCAM munitions may replace standard explosive rounds to lay a minefield in the path of an enemy. The variant also has extended-range PPCs as a fall-back weapon system for when ammunition is depleted. One is mounted in the nose, and the other two are mounted between the paired wing launchers.

The rare C configuration is the last of the designs seen during the recent Clan invasion of the Inner Sphere. Although designed as an Elemental carrier, it mounts an enormous array of weaponry, and is perfectly capable of seeing off most opponents. The ER PPC in each wing gives the craft good range potential, as do the twin large pulse lasers in an under-nose mount. Most of the nose space is taken up by a huge Ultra series 20 autocannon. This huge gun is devastating at close range, but its severe ammunition limit usually allows it to fire only in the first minutes of an engagement.

Deployment:

The *Kirghiz* is usually found in a supporting role, acting as either troop-transport or as an escort for a group of smaller ships. Although the fighter is grossly inefficient, pilots find the unique handling quirks of this ancient design strangely comforting, as opposed to the clinically precise *Scytha* and *Jengiz*, both of which are in line to depose the long-standing king of the OmniFighters.

Type: Kirghiz

Technology Base: Clan OmniFighter

Tonnage: 100

Equipment		Mass
Engine:	300 XL	9.5
Thrust	5	
Overthrust	8	
Structural Integrity:	10	
Heat Sinks:	20 [40]	10
Fuel:	75	5
Cockpit:		3
Armor Factor:	256 + 10	16
	<i>Armor Value</i>	<i>Free Space</i>
Cockpit	10 + 6	—
Nose	65	6
Wings	46/46	6/6
Fuselage	61	6 (aft)
Engine	32	—

Weapons and Ammo	Location	Tonnage
<i>Primary Weapons Configuration</i>		
LB 10-X AC	Nose	10
Ammo (LB-X) 20	Nose	2
Gauss Rifle	RW	12
Ammo (Gauss) 12	RW	2
Streak SRM 6	RW (Aft)	3
Ammo (Streak) 15	RW (Aft)	1
ER Large Laser	RW	4
Gauss Rifle	LW	12
Ammo (Gauss) 16	LW	2
Streak SRM 6	LW (Aft)	3
Ammo (Streak) 15	LW (Aft)	1
ER Large Laser	LW	4
ER Small Laser	Aft	.5

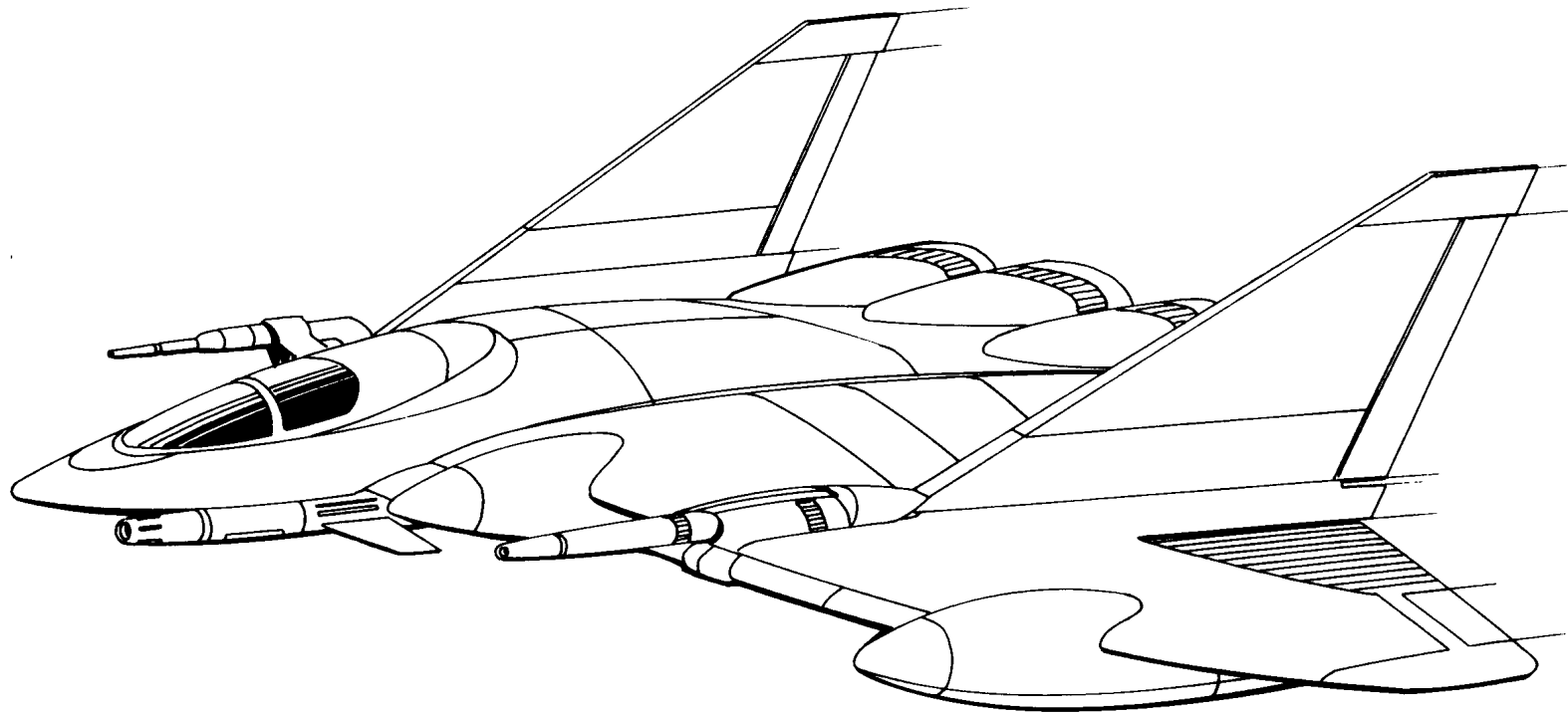

Weapons and Ammo	Location	Tonnage	Weapons and Ammo	Location	Tonnage	Weapons and Ammo	Location	Tonnage
<i>Alternate Configuration A</i>			<i>Alternate Configuration B</i>			<i>Alternate Configuration C</i>		
ER PPC	Nose	6	ER PPC	Nose	6	Ultra AC/20	Nose	12
ER PPC	Nose	6	LRM 20	Nose	5	Ammo (Ultra) 10	Nose	2
LB 2-X AC	RW	5	Ammo (LRM) 6	Nose	1	Large Pulse Laser	Nose	6
Ammo (LB-X) 45	RW	1	LRM 20	RW	5	Large Pulse Laser	Nose	6
Large Pulse Laser	RW	6	Ammo (LRM) 6	RW	1	ER Small Laser	Nose	.5
Large Pulse Laser	RW	6	LRM 20	RW	5	ER PPC	RW	6
LB 2-X AC	LW	5	Ammo (LRM) 6	RW	1	ER PPC	LW	6
Ammo (LB-X) 45	LW	1	ER PPC	RW	6	ER Large Laser	Aft	4
Large Pulse Laser	LW	6	LRM 20	LW	5	ER Large Laser	Aft	4
Large Pulse Laser	LW	6	Ammo (LRM) 6	LW	1	Cargo Pods (10)		10
ER Large Laser	Aft	4	LRM 20	LW	5			
ER Small Laser	Aft	.5	Ammo (LRM) 6	LW	1			
4 Double Heat Sinks		4	ER PPC	LW	6			
			Medium Pulse Laser	Aft	2			
			ER Small Laser	Nose	.5			
			6 Double Heat Sinks		6			

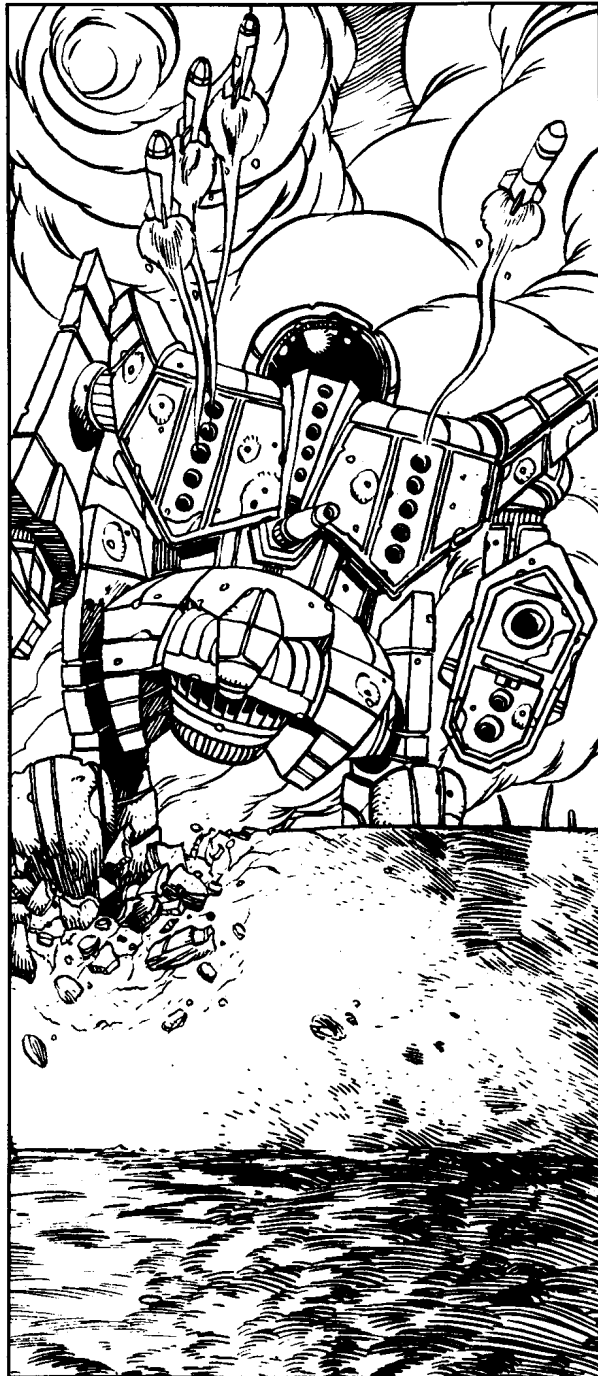

Albatross	82	Jenner IIC	100
Anvil	54	Kirghiz	150
Apollo	46	Komodo	36
Avar	132	Kraken	114
Baboon	96	Linebacker	122
Bandersnatch	66	Naga	124
Bashkir	128	Naginata	86
Battle Hawk	16	Nightsky	44
Batu	134	Penetrator	70
Behemoth	112	Peregrine	102
Berserker	88	Phantom	118
Cerberus	84	Pouncer	120
Daikyu	58	Rakshasa	72
Daimyo	32	Sabutai	144
Dart	12	Salamander	78
Falconer	68	Scarabus	24
Fireball	10	Scytha	148
Galahad	108	Snake	38
Gallowglas	60	Stealth	40
Goshawk	106	Sulla	136
Grand Titan	90	Tarantula	14
Grim Reaper	48	Tempest	56
Gunslinger	80	Thunder	64
Hammer	18	Turk	138
Hellhound	104	Vandal	130
Hercules	62	Venom	28
Hitman	20	Viper	110
Hollander	26	Visigoth	140
Huron Warrior	42	Vixen	98
Jackal	22	War Dog	74
Jagatai	142	Watchman	34
Jengiz	146	Wraith	50

BATTLETECH[®]

TECHNICAL READOUT™

3 • 0 • 5 • 5



In **3049**, without warning, Kerensky's heirs set upon the Inner Sphere in a savage series of battles known collectively as the Invasion. On Tukayyid the Com Guards brought the seemingly unstoppable Clan war machine to a halt. The Invasion ended as suddenly as it had begun, and left in its place an uneasy peace. Both sides now had an opportunity to reassess their opponent's strengths and weaknesses and respond. By **3055**, the first of a new breed of BattleMechs rolled off the assembly lines of the Inner Sphere, machines designed specifically to counter the technologically advanced weapons used by the Clans. Only time will tell if these new designs will be enough to turn the tide when battle is joined once again.

The **BattleTech Technical Readout: 3055** contains illustrations, descriptions, and complete statistics for new Inner Sphere BattleMechs and Clan OmniMechs, OmniFighters, and second-line BattleMechs.

FASA
CORPORATION

FOR USE WITH
BATTLETECH[®]



9 781555 601645

ISBN# 1-55560-164-2 \$15.00